

CONTENTS

1	Reaching to sustainable development through indigenous knowledge Esmaeel Ghorbani , Maryam Khodamoradi and Mehran Bozorgmanesh	1-6
2	Rural women's financial and Intellectual self-reliance Mohammad Reza Rezaei, Mehdi Nazarpour, Abbas Emami	7-10
3	Utilization of information and communication technologies (ICT) in education Maryam Khodamoradi , MehranBozorgmanesh and Esmaeel Ghorbani	11-15
4	Implications of micro-credit for rural women in developing countries Mohammad Reza Rezaei, Mehdi Nazarpour, Abbas Emami	16-20
5	1-4 years old infant's acute diarrhea treatment with zinc sulfate and ORS solution: A case study at Eshkenan city, Fars province, Iran Hakimeh S. Sajjadi, Ali Akbar ShaikhiFini, Abdolvahab S. Samavi	21-23
6	The Investigation and Analysis of Living Ability Level and Its Influencing Factors of Stroke Patients in Community in Zhengzhou, China Zhang Weihong, Zhang Zhenxiang, Liu Lamei, Lin Beilei, XieJunfang, Mei Yongxia, Zhang Yaqi	24-29
7	CREB1 Gene Polymorphisms are Associated with Alzheimer's Disease-Related Depression and Antidepressant Response Lu Zhang, Yu Fang, Zhaoshu Zeng, Yajun Lian, Bo Song, Yuming Xu	30-36
8	Antimicrobial Activities of Gold Nanoparticles against Major Foodborne Pathogens M. F. Zawrah and Sherein I. Abd El-Moez	37-44
9	Childhood Obesity Intervention Programs: A Review of Systematic Reviews Mazna AlMarzooqi and Chris Nagy	45-60
10	A case of hermaphroditism that presented as a pelvic cystic mass Da Zhang, Jiayang Wang, Yingzhong Fan, Weihong Zhang	61-63
11	Preliminary Study on Solid-phase Hybridization for Detection of Common Pathogenic Bacteria Causing Fungal Keratitis Zhang Yinglang, Wang Liya, Li Zhitao, Sun Shengtao	64-67
12	Interleukin-3 Receptor Alpha Chain as a Unique Marker for Leukemic Stem Cells in Acute Myeloid Leukemia Khorshed, Amira; Elsharkawy, Nahla; Elrefaey, Fatma Mansour Osman and Elgamal, Basma	68-74
13	Aflatoxins Bindingby <i>Saccharomyces Cerevisiae</i>and <i>S. boulardii</i> in Functional Cereal Based Ice-cream Eman M. Hegazy, Zeinab I. Sadek, Kawther El-Shafei and Azzat B. Abd El-Khalek	75-81
14	Response of MC3T3-E1 Cell Line to the RF Exposure at 2.4GHz Hsien-Chiao Teng, Shen Cherng	82-85

- 15 **Antihyperglycemic and Antihyperlipidemic Effects of Hesperidin and Naringin in High Fat Diet/Streptozotocin Type 2 Diabetic Rats** 91-101
Osama Mohamed Ahmed; Ayman Moawad Mahmoud; Adel Abdel-Moneim and Mohamed B. Ashour
- 16 **Singularities of Gauss Map of Pedal Hypersurface in R^{n+1}** 102-107
M. A. Soliman, Nassar. H. Abdel-All, Soad. A. Hassan and E. Dahi
- 17 **Effects of arbuscular mycorrhizal fungi against apple Powdery Mildew disease** 108-112
Zohreh Yousefi, Hossein Riahi, Hossein Khabbaz-Jolfaei and Sima Zanganeh
- 18 **Histological Hazards of Chlorpyrifos Usage on Gills and Kidneys of *Tilapia nilotica* and the Role of Vitamin E Supplement [H1] in Egypt** 113-123
Aliaa M. Issa, Azza M. Gawish, Gehad M. Esmail
- 19 **Glaucoma Treatment with the Extract of Astragalus Membranaceus in Rats Experimental Model** 124-132
Chi-Ting Horng, Ming-Liang Tsai, Jeng-Chuan Shiang, Shang-Tao Chien, Chiang-Hsiang Lu, Tsung-Hsung Chang, Fu-An Chen
- 19a **An Novel Approach for the Assembly of Bio-nanocapsules by Detonation Process** 133-136
Yeuh-Hui Lin, and Sheau-Long Lee
- 20 **Measuring Physical Fitness Condition System with Self Healthcare Capability Based on RFID Technology** 137-142
Sung-Tsun Shih, Chian-Yi Chao, Chin-Ming Hsu
- 21 **Clinicopathological Significance and Prognostic Importance of Circulating Plasma DNA Expression in Advanced Non-Small Cell Lung Cancer and its Efficacy as a Diagnostic Tool** 143-150
Abd El Halim Abu-Hamar; Hanan Shawky; Ibrahim. S. Ibrahim And Abdel Khalek H.S.

Reaching to sustainable development through indigenous knowledge

Sharareh Khodamoradi¹ and Mohammad Abedi²

¹ Department of Agricultural Extension Education, Science and Research Branch, Islamic Azad University, Tehran, Iran

² Department of Agricultural Management, Islamic Azad University, Qaemshahr Branch, Iran

*Corresponding author: abedi114@yahoo.com

Abstract: in recent decades following issues had been recognized very essential : programming and performing development plans, indigenous knowledge at farming, pest control, ranching, veterinary, nutrition, medicine, watershed management, foresting, architecture, urban planning, social associations and decision making method as sustainable technology. At on hand, reason of this great evolution can be found due to wrong policy and at the other hand in undesirable environmental consequences of these policies.

[Sharareh Khodamoradi and Mohammad Abedi. **Reaching to sustainable development through indigenous knowledge.** Life Science Journal. 2011;8(4):1-6] (ISSN:1097-8135). <http://www.lifesciencesite.com>

Keywords: sustainable development, indigenous knowledge

Introduction:

Our today's world is the contradictions and collision's world. Contradiction between cultures, religions, different societies and countries. In recently years, from Renaissance till now, as much as human had developed, they also had contradictions and collisions in their world (Azkia and imani, 2008). One of these contradictions is the contrast between tradition and modernism. Maybe we can find these contrast roots in colonial era, the time when colonists promote their innovation in their colonies. Mostly these techniques and innovations show their Indigenous knowledge and the way of their living is foolish and inefficient and tried to enter industrial ways in to their life to increase production efficiency through this way. Thus the way of their living which was been formed during thousands of years has gone to be forgotten little by little (Bouzarjmehri, 2004). We can say, agriculture part is bearing the most damage in this rapid industrialization process. Absolving old and compatible ways in agriculture part and replacing and using of implant, harvest patterns without any proportions with environment has caused decrease of production efficiency, soil erosion and hard destruction of environment during a long time. Finally, at the end of the 20th century decades, some solutions were suggested to solve these inconsistencies and problems. So the importance of Indigenous knowledge and effort in compilation of that with modern knowledge were considered and it was tried to make general and stable view in relation with environment and the way of living through this way (popzan, 2002).

By first of 21 century, world see some sings of great concerns about social, economic and environmental system sets. It is expected that world population reach to 8 billion people at 2025. Increased consumption and poverty have led to high pressure on environment. At so many areas, environment condition is more fragile than before. We have faced decay at environmental issues, especially at vast parts of developing areas of world, in spite of considerable improvement of rivers conditions and air quality at some area such as Europe and north of America. Increased consumption, rare sources and factors such as population growth and imbalanced growth, would endanger, development of different countries (Popzan, 2002). Obviously, economic development can follow unexpected social and environmental affections involving weather changes, using freshwater sources inordinately, decrease living diversity and increase inequality (Gigler, 2003). Sustainable development is outcome of development that follow multi dimensional economic activities with protect environment and its related social issues. So in current decade, presenting indigenous knowledge issue was reinforced in order to present modern approach of development, in which the issue of human-oriented of development would be insisted. In this modern attitude toward development process, environmental, social and cultural concerns were emphasized over economic interests. Indigenous knowledge is part of national capital of each nation which encompasses their beliefs, values, practices, tools and local acknowledges. This is the same knowledge that, different nations had found their foods from nature, prepared their clothing, settled in

home, educated their children, organized their society and kept health of themselves and poultries, during the centuries thereby (Eshraghi, 2004).

Comparison of Indigenous and modern knowledge:

Indigenous knowledge is different from modern knowledge in some cases that we will explain them as follow:

- Modern knowledge is reductionism (atomistic) but Indigenous knowledge is holist
- Indigenous knowledge is reductionism (atomistic) and modern knowledge is holist
- By using Indigenous knowledge we can reach to a sustainable agriculture and modern knowledge doesn't have this feature.
- Government organizations have known Indigenous knowledge unreliable but modern knowledge is supported by scientific organization and institutions.
- Indigenous knowledge is available for rural people but modern knowledge is not (Rajasekaran and et al, 1996).

Compilation of Indigenous and modern knowledge:

Many experts believe that for making a sustainable development, Indigenous and modern knowledge should be combined. Nowadays, so much efforts have done to make use of Indigenous knowledge but main part of these efforts were done for derivation and making it scientific (Burger, 1997).

Amiri Ardakani and Shah vali (2003) believe that the undesirable outcomes of development on people and rural environment is the result of using new science by scientist, so by blending and making relation between modern and Indigenous knowledge we can solve this problem.

Millar believe that by combining Indigenous and modern knowledge we can make trust between researchers and rural people, because by using this way researchers and rural people know themselves as a partner that are responsible for a common process and product. Millar believe that the trust is the reason for future development (Penny, 2001).

Experts believe that there is no way to reach sustainable development except to combine Indigenous and modern knowledge.

Indigenous and modern knowledge will complicate when:

- 1- We solve structural barriers such as political, economical, cultural and social difficulties.
- 2- We correct the thoughts on educational systems by emphasizing on learning and thought process and also correct the thoughts

on research systems by emphasizing on audience and beneficiaries needs.

- 3- We solve communication barriers that cause inactivity on relation process and steady and dynamic flow of knowledge between peasants, experts and scholars. (Emadi and Amiri Ardakani. 2004).

Concept and nature of indigenous knowledge:

Indigenous knowledge is local knowledge that is restricted to one specific culture and/or certain society. Indigenous knowledge is different with scientific knowledge that was established by universities and scientific communities. This knowledge is basis for decision making at field of agriculture, health, education, food and natural sources (Warren, 1993).

Indigenous knowledge is set of all knowledge and skills that people enjoy in one geographical area (in one environmental conditions) that most of their skills and knowledge be transmitted to next generation, and new generation would be adapted with them and add to it (Merrewij, 1999).

Since, each knowledge is consequent of individual interaction with environment, so indigenous knowledge is consequent of indigenous people interaction with their environment. Chambers with emphasis on people's role at development process believes that "rural people's knowledge" term is more eloquent than other terms for indigenous knowledge. Our purpose of rural people are producer farmers, input buyers, agriculture production sellers and etc. "people" in above phrase emphasis that this knowledge is more verbal and less has been written. This word also referred to whole knowledge system which contains concepts, beliefs, and attitudes and also contains gain, store and transmitting knowledge process (Rajasekaran, and Babu, 1996).

Sustainability and sustainable development:

Sustainability is meaning to make economic, social and environment's views in harmony with our constant needs. Sustainability includes widespread and comprehensive points and is depended on interference in social issues. It is concentrated on future and today's issues and is a world movement and in harmony with our authorities (Kolawople, 2001).

The correct concept of Sustainability has followed a certainly and warranty of life satisfaction quality for everybody. Of course for reaching to this constancy, it is not enough to decrease pollutant activities or prevent of increasing levels of consumption, but also we should make a suitable schematization for decreasing poverty and making activity for reaching to equanimity and improvement of chances in and out

of countries. Sustainability had implication on steady and sustainable conditions. Steady condition encompasses distant horizons (Dewes, 1998).

The concept of sustainable development is a complicated concept that is explained by different people in different ways. From international viewpoint, the more famous definition of sustainable development is obtained through 1978 reports by Brandt land commission with this title "our common future" that is defined as follow: sustainable development is a development that contain our modern needs without making any problems in providing future generation's needs.

Sustainable development recognize that social, economic and environmental results are related to each other and they should be equally in harmony for making decisions process. Decisions which are based on Sustainability will help future generation in reaching to a well environment and success economic (Box, 1999).

Infrastructural information in sustainable development:

Ideal and infrastructural information in sustainable development consist of:

- 1- Environment and economic integration: economic decisions should be made according to their effect on environment.
- 2- Making guarantee between generations: decisions should be made according to their effect on future generation's environment
- 3- Social justice: all the people have this right to have an environment to grow on it and be successful
- 4- Environmental protection: it is needed to protect of natural sources and support plants and animals.
- 5- Quality of life: a widespread definition of human welfare should be given which is more important than economic welfare.

Reaching to sustainable development through Indigenous knowledge:

Dictated pattern's failure through western development countries to third world countries show that Indigenous knowledge is necessary to reach development.

Untrop believe that usage of local knowledge is efficient and useful in development and Indigenous knowledge's researchers believe that they achieved to an important source for innovation in agriculture methods and a good farming production to improve the rural people's life. On his idea, some of researchers call Indigenous knowledge as a good supplement and replacement for modern knowledge and they have tried to spread the usage of

this knowledge all around the world. These plans as a "communion research with farmers" or "first is the first" are introduced. In this research method, private organs and local groups have the main role and unlink the current research plans, the tests are done with the farmers attendance in their farms and not in research centers and far from environment condition. The ways that farmers and rural people use for management of their living environment are the most scientific ways, although we couldn't understand it at the first sight (Chambers, 2000).

Eshraghi (2000) explained that by introducing sustainable development model or development environmental model and according to world food organization (FAO), sustainable development will create when applied technologies in rural development are in proportion with rural people's knowledge and also are acceptable by them. Also he says that one the main ways to reach sustainable development in society is that to have enough and necessary attention to the rural's Indigenous or local knowledge (Merrewij, 1998). It is also explained that attention to this knowledge needs a complete recognition of rural people and their knowledge that through assembling of this knowledge we can find a correct way to reach a sustainable development and we should know that the movement toward sustainable development is not possible without correct using of Indigenous knowledge. Many development experts believe that the Sustainability of this concept is at the studying of this knowledge and in becoming popular in development. Indeed, Indigenous knowledge with its holist features had known the relation between nature's components better and had smoothed the way to Sustainability of development (Gigler, 2003).

We can summarize the usage of Indigenous knowledge in development as follow:

- 1- Protection and maintenance of natural sources. Indigenous methods in management of natural sources are suitable pattern for managing natural sources in sustainable development.
- 2- The success of sustainable development plans is depended to rural people's communion at designing, schematization, performance and assessment. Use of Indigenous knowledge is necessary for rural people's communion.
- 3- Indigenous and modern knowledge should be combined because according to our needs and vulnerability of remained natural sources, none of them are able to remove our needs a lonely.
- 4- For recognizing development needs, trouble shooting problems should be polestar from rural people's view and recognizing problems and making efficient relation with rural people are possible through Indigenous knowledge.

- 5- In industrial countries, Indigenous methods are forgotten completely because of using modern knowledge in production process. As Indigenous methods are the most suitable way for achieving sustainable development goals so, many efforts were done to make this knowledge alive.

As a result not only we shouldn't forget the Indigenous knowledge but also we should use of this knowledge in developmental plans. Using Indigenous knowledge in developmental projects will help to have sustainable development in villages. So developing and not developing that were using of western development patterns for many year, should use of their Indigenous and local knowledge which is the result of many years experience and by helping these plans they can reach to a sustainable development (Brouwer, 1998).

Sustainable agriculture

Sustainable agriculture is kind of agriculture that is toward human's interests and has more efficiency of using resources, and also is in balance with environment. This definition is in harmony with changing social and politic factors at agriculture development and also it referred to kind of agriculture that is enable to produce enough foods without destroying world sources or polluting environment. It is also kind of agriculture that is follow with social values, agriculture family's welfare and supplying needed foods.

Generally sustainable agriculture is every kind of production system which follows these goals:

More complete mixing of natural processes such as food cycles, nitrogen fixation, and relation of pests and natural disasters with agriculture productions processes.

Decreasing use of that non-farming, outside and non-renewable inputs in order to reduce damage to environment or less damage to farmers and consumer's health.

More fair access to interests and productions opportunities and progress in order to access to forms of agriculture that is fairer, and also increasing self reliance between farmers and villagers (Chambers, 2000).

Using more potential biologic and genetic aptitude of plant and animal species.

Using more local knowledge including innovative approaches that scholars didn't understand it completely or farmers didn't accept it extensively.

Combined agriculture would prepare this opportunity for common systems to apply needed reforms without creating inclusive changes in it toward organic systems. Therefore, aforementioned systems are considered as medium between common

intensive agriculture and organic agriculture methods.

Two principles have especial importance at sustainable agriculture that is:

at early 1980's, with the emergence of new concepts, renewable agriculture and sustainable agriculture evolved and indeed it was based on "ecological interplay affect". now, this concept forms alter indigenous agriculture philosophy.

Sustainable agriculture presented from 1987 at global scale. In this principle, "agricultural interplay affects with society" is presented. Three issues are important about sustainability: first is enough income especially between poor people. Second is increasing access opportunity to food and its consumption. This means that more food should be prepared through increasing production and improving marketing. Third issue contains protecting and improving natural resources (Louise, 2000).

Conclusion:

Not only attendance of indigenous knowledge is necessary for applied researches but is important at compatibility researches and it enforced importance of attending to indigenous people and their knowledge. Therefore, applying affective strategy for transmitting technology has been among from affective fields at attending to indigenous people's knowledge and especially experts; because, development institutes realized positive their affects for doing this more than ever (Merrewij 1998).

Indigenous knowledge has been manifested at sustainable process and improving extension programs at industrial countries of world, very well. Indigenous knowledge related to agriculture, medicine, food and architecture has been widely used At European countries, USA, Canada, Australia, by new names.

At one research as a name of "analyzing position of indigenous knowledge at sustainable rural development" that was done by Buzarjomhore (2005) it was signified that although there are some differences between indigenous and formal knowledge, but they should not be compared, because they are complementary of each other and it is possible to gain successes by synthesizing them that is impossible lonely. Base on new paradigms of rural development in order to solve rural problems, we should first refer to indigenous solutions and if it was working, then we should reinforce it; if not we should test and use outside solutions. Findings of one research done by Emadi and Amiri (2004), as "Synthesizing indigenous knowledge and formal knowledge as necessity for accessing to sustainable rural development", has shown that dominated belief among educated groups toward Indigenous s and

their knowledge is precondition of every interaction, synthesis and relation. Creating revolution in formal education systems in order to attending empirical knowledge area is considered as one of main necessity of this synthesis that is outcome of years of researches. Researchers attention to “exploiter’s accumulated experimental and historical wisdom” is one of other necessities of this revolution by using cooperative, qualitative and filed methods. Also, applying mutual extension ways and creating revolution at communication system between governmental, education-extension centers and farmers and rural people so that they be interacting, was considered as precondition and necessities. At researches as “indigenous knowledge at development process” done by Karimi (2003), findings show that indigenous knowledge is principal factor and main source at the field of research of sustainable development, decreasing poverty, enabling local men and attracting their participation at activities and rural development programs, developing and producing appropriate technology, self-reliance of rural societies and country.

***Corresponding Author:**

Mohammad Abedi

Department of Agricultural Management, Islamic

Azad University, Qaemshahr Branch, Iran

E-mail: abedi114@yahoo.com

References:

1. Azkia, M and Imani A, Sustainable Rural Development-Publications Information, Tehran, 2008.
2. Eshraghi, G, Indigenous Knowledge and Development Planning, Journal of Forest and Rangeland, No. 40, Forest, Rangeland and Watershed country, 2000.
3. Amiri Ardekani, M. and Shahvali, M. Principles, concepts and indigenous knowledge Agriculture "series of publications and development of villages No. 34, Second Edition 2003.
4. Bouzarjmehri, Kh. indigenous farming knowledge of gender and its role in Rural Development and Research, Centre of Quarterly Tehran University Women (Women's Research), 2004.
5. Popzan, A. Design and compilation of indigenous knowledge, modern media in order to achieve a partnership approach in Kermanshah province - end of period letter PhD Tehran University Faculty of Agriculture to help Azkia and Seyed Mahmoud Hosseini. 2002.
6. Chambers, Robert - rural development, priority part to the poor (supporting vulnerable groups), translated by Mustafa Azkia, Tehran University Press, 2000.
7. Farrokhi, S and Yaghoubi, J. technology development through indigenous knowledge systems with agricultural research - Journal of Jihad, No. 224-225, 2002.
8. Zare, H and Yaghoubi, J. attitude to the indigenous knowledge - Journal of jihad, No. 231-230, 2003.
9. Razavi, M. Agriculture and natural resources, indigenous knowledge and combining it with modern knowledge, Jihad magazine, twenty-five years, No. 269, 1999.
10. Emadi, M and Amiri Ardekani, M. - combining indigenous knowledge and formal knowledge, necessary to achieve sustainable development of Agriculture-Rural Development Publication No. 54, 2004.
11. Emadi, M and Abbasi, E. indigenous knowledge and sustainable development of villages, the old view of a new zone, and development of village's No. 33, 2001.
12. Karami, R and Moradi, Kh. The place of research, training and promoting the preservation of indigenous knowledge, Journal of Jihad, No. 255, 2003.
13. Nowroozi, A and Alagha, E. a new category of indigenous knowledge in rural development research - Journal of jihad, No. 223-222, 2000.
14. Brouwer, Jan. (1998). IK, IKS and ITK. Indigenous knowledge and Development Monitor. Vol.6, Issue 3, p, 13.
15. Gigler, S, et al. (2003). ICT for Indigenous Development. Available at: [http:// topics.Developmentgateway.org/ ict/ sdm/ preview Document](http://topics.Developmentgateway.org/ict/sdm/previewDocument). Do ~ active Document Id 2003.
16. Merrewij, A. v. (1998). Three definitions of indigenous knowledge. Indigenous knowledge and Development Monitor. Vol.6, Issue 3, p, 13.
17. Box, L. (1999), for the fun of it, Guest Column, Indigenous knowledge and Development Monitor 792;36.
18. Kolawople, D. (2001), Local Knowledge Utilization and Sustainable rural development in the 21 St. Centuries, IK Monitor Article (9-1).
19. Dewes, w. (1998), Introduction, p. 3in traditional knowledge and sustainable in S. H. Davis and K. Ebbe (Eds) Proceedings of a conference held at the World Bank Washington, D.C, sept. 27-28. Environmentally Sustainable proceeding series No. 4.
20. Louise, G (2000), Working with indigenous knowledge (A guide for researchers), published by the International Development research Centre, po Box 8500 Ottawa. On, Canada K1G 3H9.

21. Penny R. A (2001), Gender and Indigenous Knowledge, IK&D M, Article (9-1).
22. Rajasekaran, B.D.D. M. Warren and S.C. Babu (1996), Indigenous natural-resource management system for sustainable agricultural development-a global perspective Journal of International Development 3 (4).
23. Warren, D. M. (1999) 'The role of indigenous Knowledge and biotechnology in sustainable agricultural development' A Keynote Address presented at Southwestern Nigerian Regional Workshop on indigenous knowledge and Biotechnology, Obafemi Awolowo university, Ile- Ife, OsunState, Nigeria 30 July.
24. Agrawal. A ,(۲۰۰۲) "Dismantling the Divide between Indigenous and scientific knowledge "Development and change vol 26.No3.
25. Ahmed, M. 2000 .Indigenous Knowledge for Sustainable Development in the Sudan . Khartoum, Sudan. Khartoum University Press.
26. Appleton, H., Jeans, and A. 1995" Technology from the People: Technology Transfer and Indigenous Knowledge ."Science, Technology and Development.
27. Burger, J. (1997)The Gaia Atlas of First Peoples: A Future for the Indigenous World, Penguin Books, and Ringwood.
28. Smita M,(2003)Women's indigenous knowledge of forest management in Orissa, [http://www.gendermainstreamingasia.org/img/b1 .PDF](http://www.gendermainstreamingasia.org/img/b1.PDF)

3/4/2011

Rural women's financial and Intellectual self-reliance

¹Mohammad Reza Rezaei, ² Mehdi Nazarpour, ³ Abbas Emami
^{1,2,3} Marvdasht Branch, Islamic Azad University, Marvdasht, Iran
 *Corresponding author: fereshteh12150@yahoo.com

Abstract: By the activities such as promotional services for increasing the rural women's skills in various fields and by increasing the rural women's knowledge in social, politic, cultural and economic fields and by using micro-credit plans for motivate and support women in economic development and their self-reliance, we can increase the rural women's empowerment. Rural women's financial self-reliance has many social & economic influence as it made them self-sufficiency, it changes economic behavior and it makes women independent, it will be effective in economic development in family & society , it also improve the women's roles in society and it causes self-confidence in women , it builds family strength and it causes to respect the women rights more than before and women will become equal with men in all their rights, of course we won't have patriarchy in the family . The women's empowerment in the rural society will increase because of all the aspects of rural women's self-reliance and their position will be confirmed.

[Mohammad Reza Rezaei, Mehdi Nazarpour and Abbas Emami. **Rural women's financial and Intellectual self-reliance**. Life Science Journal. 2011;8(4):7-10] (ISSN:1097-8135). <http://www.lifesciencesite.com>.

Keywords: financial self-reliance, rural women

Introduction:

Rural women constitute about half of the world's population and in the world production supply they have energetic communion and constitute a great part of agriculture workforce. They constitute% 50 of the workforce and they participate in the production of half of the foods in the agriculture section. As an example the rural women constitute about 70 to% 80 of agriculture workforce in sub-Saharan Africa, %65 in Asia, %45 in Latin American & Caribbean, %80 in Nigeria & Tunisia and %80 in India, but their role in production system is the men's supplements roles and this causes a big responsibility inside their mother & wife duties and it takes a great time and energy of them. Studies in this field show that women spend about two thirds of their time for production, management & organize of their house as the men spend only one third of their time for such things. (Varzegar & Azizi 1367).

Poverty spreading in village is a global issue. According to the Fao finding about % 75 of world's poor people that are more than 1 milliard people are living in rural zone and more than % 70 of this poverty people are women. As the most of the people who are poor are living in village and are women is the reason for insufficiency of rural development programs.

One of the other basic barriers in development of rural women is their independent inaccessibility to get credits for investment in their job. Although their illiteracy is the big barrier to use of bank credits, but this view that women are dependent people that their husband should decide about their financial decisions is the other reason that rural women couldn't access

to official credits. Maybe these barriers are the reason why rural women are happy about applying micro-credit thought in village. (Najafi, 2007).

It seems that experiences which are obtained from performing financial programs in some villages in the developing countries could answer clearly to such questions.

A glimpse to previous planning about rural development in the world shows that from 1950 many developing countries understood that the main reason for making their economic growth (development) slowly in their countries is the weakness of investment in the agriculture part. Although many countries by patterning from developed societies have proceeded to improve & develop their industrial agriculture part and by this action not only had irreparable damages to many traditional farmers but also the main problem (the lack of capital sources) is also remained in the rural regions. (Rahimi, 2001).

Women's self-reliance and independency were the outcome of giving credits to women and in some cases were the obstacle of receiving credits by women which is necessary to explain about them shortly.

Cultural & social effects of rural women's financial self-reliance

As it mentioned before the traditional culture in villages was the reason for weakening women rights and made them oppressed, it is possible that women's self-reliance & financial independency in villages make some crudities (malformation) in the family and village for a short a short time, but we can't disregard it's positive outcome in the social &

cultural occasions in the long time, here we will discuss about some of these outcomes (Goetz and Sengupta, 2003)

1- Preferment of women role and their social place:

Women's financial self-reliance can increase the women's social role & place in the villages. In the new condition some of their assignment roles could change to acquisitive roles. The women should use of all their power & energy for doing their acquisitive roles. Thus they can find active view to different functions. The people & groups could increase their social place in the village with improving their social role. If their role and social place preferment be accompanied with the increasing of social intelligence & knowledge, it can have more effect culturally. (Amiri, 2000)

2- Increasing self-confidence:

Self-reliance in different life aspects can increase people's self-confidence. Rural women who are financially independent can live peacefully. With decreasing their problems in life, their self-confidence will increase. And self-confidence is one of personality & mentally condition for being success in life.

3- Family consistency:

At the first, it seems that rural women's financial independency is not acceptable by their husband and this causes some gaps in their family's relations. But little by little these problems will be solved by increasing the rural people's knowledge. Usually poverty is one of the reasons which will destroy or decrease family's consistency. Women by working and having income can help their husband & family. (Fakhraee, 1381)

4- Change in family's relation:

The rural women with having a job and financial independency can change the viewpoint of people who live in villages and cities and they will not look at the rural women as a weak and dependent people. But also their title and place will increase among their families. So by changing people's view to the women, gently we can see some changes in their family's relation which will have respect to the women's right. By increasing women's knowledge and by introducing new rural institution which give financial & authority service to the women, their stimulus (motivation) for reaching their social rights will increase and they try more than before (Amiri, 2000).

5- Making patriarchy weak in the family:

Gently, with changing family's relation in the villages and by increasing rural people's knowledge, we can make the men and women's right equal and also we wont have patriarchy in the family, although patriarchy has historic and olden root in our villages

but with improving women's position and increasing their cultural and social know ledge we can destroy patriarchy in the rural families. . (Chowdhury, 2005).

6- Population and family adjustment:

The practitioner women's view about the number of the children is different; studies show that practitioner women are interested to fewer children to the house keeper women.

By decreasing families in the village and women's financial independency we are more hopeful to adjust family's population in the future because villages have important role in the population increase in Iran. (Shaditalab 75).

Conclusion & discussion:

If rural women could provide a job for them by getting credits, loan and other financial convenience, through their income they can get self-reliance or financial independency and we will see social, cultural & economic change in village. The question here is that if these changes have positive or negative aspects in the village? It's natural that every change in social phenomenon has both positive and negative aspect, but which is Important here is that which aspect is more than the other and it depends to different condition in various societies. In our rural society there is an especial social & cultural kind that it's outcome maybe different and in some case inconsistent. With these actions rural women could be in idealistic economic condition and they could live without dependency to their husband's income. In most of the villages in Iran there is patriarchy in the families which is not acceptable for the most of the rural people and groups. When rural women became financially independent, it's acceptable to see its cultural & social outcomes.

Giving the right that women make decision, independency to their family, increasing the cultural knowledge among them& making relation with new institutions, having independency in making decision about marriage, occupation, migration & something like this are the right that women have got it.

Honduras, Mali and Thailand". This approach looks for empowering women through financial services with education. In this approach, women get familiar with importance of credits through education and extension and also familiar with ways to access it through establishing different groups.

Shahnaj and chaudhury(2009) in research as "credits and its role on empowering women " concluded that there is meaningful relation between attending in credits programs and empowering women , at economical dimensions .Ruhail amin and others (2010) found that those who joined credit

funds had more ability rather than those who didn't. Jameela (2010) presented that credit programs has shown lot of affects on empowering women so that has increased their social, politic and economic ability. Thus it is obvious that credits programs and its educational and empowering programs can be affective on social, humane and economic development or rural society, if it be associated with proper and gradual practices and base on reciprocal communications principles and apply opinion of local society. Maybe the main challenges that threaten credits associations , is lack of necessary emphasizes on social dimensions and on reinforcing their basics, that practically cause that this social foundations lose its efficiency soon and practically changed to unsuccessful institution.

In order to overcoming dominant consideration, experts believe that we should consider following in protection process of these social institutions

-Relating public established institutions with each other and networking established institutions

-Emphasis on stability and self reliance of management system of credits institutions from financial and economic dimensions

-Efforts to gain local confidence and credibility among contacts

-Effectiveness of costs and economic and financial efficiency inside established institutions

Also following suggestions has been offered:

- providing extension educations for men in order to believe economic role of their women, and give them chance of corporation on all economic , credits fields
- Since that base of credit association, forms base on People Corporation, so it's good chance to use these communities to expand extension-education activities. so it is better to consider special programs on different extensional filed such as agriculture , ranching, family health, housekeeping economy and other fields accordance to condition of region and rural women's needs.

Giving the right that women make decision, independency to their family, increasing the cultural knowledge among them& making relation with new institutions, having independency in making decision about marriage, occupation, migration & something like this are the right that women have got it.

Women by getting these rights can make change in the rural cultural & social issues which make disfunction & crudity in their family's relation. However, rural women's self-reliance has caused improvement in the economic, social & cultural

issues. For solving women's self-reliance problems we can do these activities:

- Giving promotional services for increasing rural women's skills in various fields.
- Giving promotional instructions to men for believing their women's economic role & their women opportunity to participate in all economic, authority & ... aspects.
- Increasing rural women's knowledge in all social, political, cultural & economic fields.
- Making use of micro-credits programs to motivate & support women for doing economic affairs better & finally to make women self-reliance.

Its result is that, exploiter can't access to desirable condition of production efficiency at first. Secondly, he would incapable for loan repayment. Third, his activity doesn't contain consistency. Fourth, remarkable part of provided credits would exit from production cycle due to exploiter's incapability and lack of skill in exploiter. His technical and occupation skill would improve, if credit is being provided for exploiter as a credit program. and he knows and can applies loan properly and well timed for production and activity, so condition of production and level of income , level of life and would improve.

Women by getting these rights can make change in the rural cultural & social issues which make disfunction & crudity in their family's relation. However, rural women's self-reliance has caused improvement in the economic, social & cultural issues. For solving women's self-reliance problems we can do these activities:

- Giving promotional services for increasing rural women's skills in various fields.
- Giving promotional instructions to men for believing their women's economic role & their women opportunity to participate in all economic, authority & ... aspects.
- Increasing rural women's knowledge in all social, political, cultural & economic fields.
- Making use of micro-credits programs to motivate & support women for doing economic affairs better & finally to make women self-reliance.

***Corresponding Author:**

Mehdi Nazarpour
 Marvdasht Branch, Islamic Azad University,
 Marvdasht, Iran
 E-mail: fereshteh12150@yahoo.com

Reference:

- 1- Amiri, Soodabeh. Female centered sustainable human development. *Journal of Agricultural and Development Economics*, 2000, No. 9.
1. Araghzadeh, M. institutions active in the field of providing financial services to rural women. *Conference Proceedings rural women micro-credit. (Volume II)*, 2002. 167-153.
2. Bakhshoodeh M. and Habibullah Salami. Article "The role of agricultural banks in reducing poverty with emphasis on micro-credit." *Conference on rural development and poverty reduction, agricultural banks, Tehran, 2005.*
3. Chabokru. GH, Mokhtari, D. and Abdshahi. A. Paper "of micro-credit on the value added of agricultural sector in Iran." *Conference on rural development and poverty reduction, agricultural banks, Tehran, 2005.*
4. Chowdhury. M. J. A. *The Role of Micro-credit in Alleviation of Poverty: A study of the Grameen Bank in Bangladesh.* Department of Economics, University of Stirling, Scotland and Department of Finance and Banking, University of Dhaka, Bangladesh, 2005.
5. Fakhraee, S. *Economic and social effects of their financial reliance of women in rural communities*, 2002.
6. Fiona Steele, Sajeda Amin and Ruchira T. Naved. *The Impact of an Integrated Micro-credit Program on Women's Empowerment and Fertility Behavior in Rural Bangladesh*, 2008.
7. Goetz, A. and Rina Sengupta, R. "Who Takes the Credit? Gender, Power, and Control over Loan Use in Rural Credit Programs in Bangladesh." *World Development* 24 (1), 2003, 45-63.
8. Ghaffari, GH. *The role of women and social development.* *Women's Magazine*, 2000, No. 10, p. 15.
9. Jameela v. a. *Micro credit, empowerment and diversion of loan use*, 2010.
10. Najafi. M. *Participatory evaluation of rural women micro-credit fund scheme, the organization promoting education and agricultural research*, 2007.
11. Rahimi, A. *Review of micro-credit properties.* *Conference Proceedings Volume II of rural women micro-credit and promoting people's participation* Deputy Ministry of Agriculture - Bureau of Women Affairs in collaboration with Al-Zahra University, Agricultural Bank, Tehran, 2001.
12. Ruhul amin, yipping li and ashrad u. Ahmad. *Women's credit programs and family planning in rural Bangladesh*, 2010.
13. Varzgar, sh. and azizi. M. *Evaluation of labor force participation of rural women in cotton production and its related factors in the region and dome of Gorgan*, 2001, P. 318.

3/5/2011

Utilization of information and communication technologies (ICT) in education

¹ Fatemeh Vahidi, ² Ali Badragheh

^{1,2} Mahabad Branch, Islamic Azad University, Mahabad, Iran

*Corresponding author: khaterehsiyar@yahoo.com

Abstract: Policy makers and service providers have increasingly come to view information and communication technologies (ICT), and particularly the Internet, as an important tool in providing disadvantaged groups and areas with access to information, services and markets that would otherwise be inaccessible. The concept of development of the rural, today, is not just project initiatives and governance; it is much more beyond that. This paper uncovers a whole plethora of ICT emergence as a technology of the new millennium. Against the backdrop of the ongoing ICT boom, this paper makes an attempt towards studying its applications and usage planning process and policy making for the rural communities focusing on how it helps in aligning the key factors and reduce the problems of alienation, fragmentation and dislocation of knowledge.

[Fatemeh Vahidi and Ali Badragheh. **Utilization of information and communication technologies (ICT) in education.** Life Science Journal. 2011;8(4):11-15] (ISSN:1097-8135). <http://www.lifesciencesite.com>.

Keywords information and communication technologies (ICT), education

Introduction:

Information and Communication technologies (ICT) have a potential for economic growth and social empowerment (Nandi, 2002). Direct or indirect application of ICT, in rural development sector has also been referred to as "Rural Informatics". Rural economies can be benefited from ICT by focusing on social production, social consumption and social services in the rural areas (Malhotra, 2001). The inculcation of a Citizen-to-Government (C2G) and Citizen-to-Citizen (C2C) interface would provide this link that would also lead to community participation in design and implementation of ICT interventions. This in return could promise better economic opportunities as well as social inclusion of rural people in the processes of governance. Such attributes in the social set up are essential prerequisites for good governance and rural development.

Concerns about educational quality and educational opportunities with the necessity of developing those most vulnerable are the accumulation of globalization is symbiotic. Generally, "the changes of globalization in developing countries, on low-income groups, especially women and girls and" low skill workers, as well as all groups applying for and obtaining new skills to press. (Bellamy and Taylor, 1998).

Technologies (ICT) during the past two decades have had many points of contact with education and training. The development of technology is placing new demands on expertise, and it is also leading to the increased use of information technology (IT) in instruction and learning. As early as in the 1970s discussions of the future of school

systems started to pay attention to the opportunities provided by ICT.

Now with the approach of the new millennium, IT is playing an increasingly central role in almost all future planning of schools and instruction. (World Bank, 1999).

The process of development in a country is to be aided by its governance. The goal of governance "should be to develop capacities that are needed to realize development that gives priority to the poor, and creates needed opportunities for employment and other livelihoods" (The World Bank, 1992, UNDP, 1994). Increased number of poor, hungry or marginalized people in a country represents decrease in its quality of governance. To promote development, various studies have proposed governance in the contextual realities of each country, including veritable participation of citizens in the governmental decision-making process (Grindle, 2004; Evans and David, 2006). Several

Institutions and experts accept Governance as a reflexive process, wherein policies, institutions, outcomes and analysis interact, to maximize the process of participatory development (UNDP, 1997; Ludden, 2005; Mehta, 2006).

Information and communication technologies (ICT), including radio and television and the newer digital technologies like computers and the Internet as potentially are introduced powerful tools and activators of educational reform and changes. different ICT, when properly applied can be developed to help access to education and the relationship between training and workshops to strengthen the increasingly digital, the quality of education also helped to create teaching and learning

in an active process connected to real life high take. However, the experience of being raised by ICT in the classroom and other educational sites around the world during the last few decades proves that is not automatic fully realize the potential benefits of ICT training. (Guptaand et al, 2004)

But nowadays, ICT is more than a technology. Although the old technologies such as telephone, radio and television, will be less attention in the past but were used as educational tools. For example, "radio and television are used for over forty years to open and distance education. In this regard, although print remains the most expensive method and therefore available, but in developed and developing countries is provided the most prominent mechanism. Internet and computer use in developing countries still in early stages are spent and if they used are limited due to is expensive infrastructure and access to them.

1- The challenges to educational policy and planning:

To achieve promotion and reform in education through ICT, should be considered explicit and clear objectives, guidelines, mobilize the required resources and political requirements for understanding the primary goal in all levels. Some essential elements in planning for ICT are listed below:

1-1-A correct analysis of the current state of education system. ICT impacts should be considered institutionalized as current methods, respectively, and especially "those ICT to drive forward and the barriers should be recognized, as well as those related to education and training programs, infrastructure, capacity building, language and content and finance.(Collis, 2004).

1-2-Educational objectives at different levels of education, as well as various aspects of ICT applications that can best meet these goals in the state be used. Policymakers must understand the potential of ICT in various different goals when the concepts are used.

As well as may alert best practices around the world, about the priority educational needs, financial and

Human resources and capacity bottlenecks the country and how these experiences can be adapted to the specific needs of the country (Hakkarainen, 2000).

1-3- Identifying stakeholders and coordinating actions among different interest groups.

1-4- Conducting chosen model based on ICT, should are tested on a small scale, best design models or

those who proved they can be used in other areas. Such guidance is essential for identifying, correcting, feasibility, etc.

1-5- Preparation of available financial resources and identify strategies to generate financial resources for strengthening the application of ICT in the long run. (Harris, 1999).

2- Infrastructural challenges in education of based on ICT:

Before any program of based on ICT to run, an Educational technology infrastructure is placed above infrastructure of information and telecommunications. Policy makers and planners should carefully take into account the following:

2-1- At first, is there suitable rooms and buildings for placing technology? Building schools in countries that they are too old, is required to ensure an extensive repair of electrical wiring system, building, cooling and heating, ventilation and safety.(Swaminathan, 2002).

2-2- are there electricity and phone? Developing countries, vast areas still lack adequate power and several miles away their nearest phone station. In some African countries are using wireless technology, although expensive approach, but other developing countries with poor telecommunications can try this solution.

2-3- Policy makers must be examined also attending a variety of ICT in the country in general and the educational system (all levels) in particular. For example, "a primary need in education of based on ICT (using a computer and via online) access to computer and Internet services at the community level, especially schools and host families (Virgo, 2008).

3- Challenges of Capacity building:

Various attempts should be occur throughout the educational system integration for success of ICT.

3-1- professional development of teachers should be have five-axis: (Dadgaran, 2002)

- Skills in specific applications
- merging in existing curriculum
- curriculum changes regarding the application of IT (including changes in instructional design)
- Changes in the teacher's role
- to support educational theories

Ideally these should be served in pre-service training of teachers and be upgraded in in-service. In

some countries, like Singapore, Malaysia and England, is required to recognize the application of ICT training courses. ICT will change speedily technologies and in this regard even the most elite teachers need to promote ICT skills and are welcome the latest developments and best practices.

Although the first focus is skills with specific applications but other four focus is importance. Research on ICT application in different fields as education and uniform over the years show disability as a barrier to teachers successfully plan, understand why they should use ICT and how to properly get the best teaching aid. (Falk and Wolfmayr, 2008).

Unfortunately, most teacher professional development in ICT has been the emphasis on teaching tools and their application in education. If learning process being Student centered, anxiety of teachers from being struck by the technology or the loss of authority in the classroom, can be prevented and as a deep understanding and feeling a severe change in their role than do not have to be raised.

Whether ICT will replace teachers? Answer is "no". In fact, with promoting ICT in the classroom, teacher's role in learning process is even more important. What can and should change is the role of teacher. Likewise the role of students "developed since the ICT can be opened classroom doors to the outside world, the community could be a new role in class. (Mohseni, 2003).

Since education is transferred in model centered- teacher to centered-student model, the unique authority of teachers was low and are known more than as facilitators, observers and trainers (of the absolute ruler to guide the way).

Primary task of the teacher is teaching students how to ask questions and to discuss the issue, make hypotheses, and then if necessary to reach Information about finding the issues raised in relation to the assessment. (FAO, 2000).

Because of improved ICT training a new experience, even for teachers, teachers learn educational process and new things are discovered among the students.

Plus this is not unusual to see students in a class based on ICT undertake formal and informal roles of teacher to younger friends and students and sometimes even for teachers. (Saadan, 2001).

Teachers and students from different schools, experts, parents, community and business leaders, politicians and other stakeholders are involved in the educational process areas as resource persons, critic, observer and encouraging.

They also are essential and general customers for student published work on the Web or other media. Not many teachers reluctant to use ICT are especially "computer and internet usage. Hannafin

and Savenye were found several reasons for this reluctance:

- Poor design of software,
- pessimism towards Computer effects of increasing efficiency in teaching,
- lack of managerial support,
- the time and efforts to increase technology and learn how to use for training
- Fear of losing authority in the classroom, as class is centered student.

These are points that should be served in pre-service training and professional development programs in in-service training of teachers. In in-service training about professional development of ICT teachers, should in the long run, be flexible and possible. (Cecchini and talat, 2002).

For many teachers lack the necessary conditions, and with less rights in developing countries, adaptation of ICT effectively subject to granting the necessary opportunities for learning things that they need to learn according to their own experience. Motivation of teachers and supporting teachers to pursue professional development plan is necessary. That can be promoted as with ICT initiatives for teachers who are classroom teachers or ensure adequate access to technology is after training.

Results:

This paper is a multidisciplinary study of ICT initiatives for rural development. It emphasizes adoption of a more systematic approach for integrating Traditional Knowledge Systems (TKS) and ICT inputs to ensure sustainability of rural e-governance projects. The study of literature related to rural development and e-governance has indicated various issues impeding success of such initiatives. The main issues are lack of localization of content for rural communities and inadequate participation of rural communities in design of rural ICT initiatives. The study therefore suggests the use the systems-approach to integrate the relevant TKS along with ICT initiatives in the design of e-governance systems for rural development. This participatory approach can lead to creation of more acceptable and sustainable e-governance projects.

Regardless of the wide differences in ICT access between rich and poor countries and between different groups in the country, there are concerns that challenge the application of ICT in education with the existing differences among the lines of economic, social, cultural, geographic and gender will be broader. Everyone equal opportunities in terms of suitability for participation are necessary, but access to various factors, either as users or as producers through their sources is difficult and

heavy. Therefore, the primary differences enhance and even grow. Consequently, programmers' international education is faced with a difficult challenge and how to help solve the problem and its development.

Promoting ICT in education, when done without careful study, can lead to the marginalization of those with more favorable conditions are unknown. For example, "women compared with men, because of illiteracy, lack of higher education, lack of time and mobility and poverty, controlling access to ICT and fewer opportunities for training are relevant. Also, more boys than girls' access to computers at home and school are not strange to say that if more boys than girls are willing to work with computers. The report of the University Association of American Women is that "Although some girls have an important gender gap have been limited, but today's technology, technology club, and boys in public schools while its own problems and programs are settled girls use computers for word processing the brand". In an assessment in four African countries, the activities organized by World links remote international cooperation on projects between teachers and students in developing countries will promote, despite creating programs without regard to sex contacts, sexual inequalities remain Uganda and Ghana. In addition, while more girls than boys in relation to academic performance and advanced communication skills program will enjoy more than boys, but they were unable to perform their technological skills were. A set of economic factors, organizational and cultural differences involved in the social.

"The high ratio of students to computers and politics, whoever came first, the first is used in accordance with the girls wanted it." Girls travel restrictions in the early hours of daily work and home responsibilities are that this will limit their access. Also because local patriarchal beliefs dominate the boys are in the computer lab environment. Including proposed measures to address this discrimination, strategies to encourage schools to create "fair use" in the computer labs and the holding of meetings and sexual sensibilities conductivity decreased defense duties after school girls. ICT provides access to only a small part of the action is created equal. Equal attention should also be applied to ensure the technology really "is used by learners and ways of how well their needs will cure.

An educational program that reinforced this approach shows the overall program is bilingual. The program seeks to establish technology learning centers for bilingual teachers, students, teachers, parents and community members. Technical teams from each center three students, two teachers and the

director of the Center with at least one female student and a teacher are female.

Another example of a general approach to the application of ICT in education, radio education project Gobi Women of Mongolia, which seeks to provide professional and educational structure of women's favorite courses around the nomads and their opportunities for income generation.

It contains topics such as livestock rearing, family support (family planning, health, nutrition and health) to create income in the application of local raw materials and basic skills for the job is a new market.

***Corresponding Author:**

Fatemeh Vahidi
Mahabad Branch, Islamic Azad University,
Mahabad, Iran

*Corresponding author: khaterehsiyar@yahoo.com

References

1. Andersen, K.V. and H.Z. Henriksen. (2006). E-Government maturity models: Extension of the Layne and Lee model" Government Information Quarterly, Volume 23, Issue 2 (2006): 236-248.
2. Bellamy, Christine and A. Taylor. (1998). Contexts for Governing in the Information age, In Governing in the Information Age, Christine Bellamy and A. Taylor, 1-2. Buckingham, Philadelphia: Open University Press, 1998.
3. Burkey, Stan. (2000). People First: A Guide to Self-reliant, Participatory Rural Development, Stan Burkey, 29-39. London and New-Jersey: Zed Books Ltd, 2000.
4. Cecchini, Simone and Christopher Scott. (2003). Can information and communications technology applications contribute to poverty reduction? Lessons from rural India, Information Technology for Development, Vol. 10, Issue 2 (2003): 73 – 84.
5. Chambers, Robert. (1983). Rural Development: Putting the Last First, Robert Chambers, 147. London: Longman, 1983. Chariar, V.M. (2005), Rejuvenating Traditional Knowledge Systems of India" (unpublished).
6. Evans, Donna and David C. Yen. (2006). E-Government: Evolving relationship of Citizens and Government, Domestic, and International Development, Government Information Quarterly, Volume 23, Issue 2 (2006): 207-235.
7. Grindle, Merilee S. (2004). Good Enough Governance: Poverty Reduction and Reform in Developing Countries, Governance An International Journal of Policy, Administrators

- & Institutions, Vol. 15, No. 4, (October, 2004), Blackwell Publishing, USA/UK: 525-548. 3/5/2011
8. Gupta, M.P., Prabhat Kumar and Jaijit Bhattacharya. (2004). New Paradigms and Value Propositions in e-Governance In Government Online: Opportunities and Challenges. M.P. Gupta, Prabhat Kumar and Jaijit Bhattacharya, 77. New-Delhi, India: Tata McGraw Hill 2004.
 9. Jauhari, Vinnie. (2004). Information Technology, Corporate Business Firms and Sustainable Development: Lessons from Cases of Success from India, Presented in International Seminar on “e-Commerce and Economic Development” by Foundation for Public Economics and Policy Research, December 11, 2004.
 10. Ludden, David. (2005), Development Regimes in South Asia: History and the Governance Conundrum, Economic and Political Weekly, September 10, 2005: 4042.
 11. Malhotra, Charru. (2001). Rural Informatics and Information Technology Policies for Rural Development in India in emerging institutions, In Proceedings of NIRD Foundation Day Seminar for Decentralized Rural Development, edited by S.P. Jain, 223-250, Hyderabad: NIRD, Hyderabad, India, January 7-8, 2001.
 12. Mehta, Dinesh. (2006). Urban Governance: Lessons from Best Practices in Asia” In New Public Management, edited by Shah and J. Parth, 11. New Delhi, India: Centre for Civil Society, 2006.
 13. Nandi, B. (2002). Role of Telecommunications in Developing Countries in the 21st century, 14th Biennial Conference Seoul: International Telecommunications Society (ITS), 2002.
 14. Rogers, E. and P. Shukla. (2001). The Role of Telecasters in Development and the Digital Divide, Journal of Development Communication, 12(2): 26-31.
 15. Singh, Katar. (1999). Rural Development: Principles, Policies and Management, Katar Singh (Second Edition), 21. New-Delhi, India: Sage Publications.
 16. UNDP. (1994). Initiatives for Change <http://www.mirror.undp.org/magnet/policy/chapter1.htm>, accessed on May 25, 2007.
 17. UNDP. (1997). UNDP Policy Document on Governance for Sustainable Human Development.
 18. The World Bank Report. (1992). Governance and Development. Washington D.C.
 19. The World Bank Report. (1997). Rural Development: From Vision to Action – A Sector Strategy. Washington D.C.

Implications of micro-credit for rural women in developing countries

¹Mohammad Reza Rezaei, ² Mehdi Nazarpour, ³ Abbas Emami
^{1,2,3} Marvdasht Branch, Islamic Azad University, Marvdasht, Iran
 *Corresponding author: fereshteh12150@yahoo.com

Abstract: paying part of cost of life by government or charities , establishing forums to analyze family supervisor women's problems , supplying necessary facilities to grow and improve child's life quality and paying facilities to provide sustainable employment , are among most important approaches to support family supervisor women. Paying credit facilities to access sustainable employment with easy terms at limited time, is one of the most important approaches to support family supervisor women. Because alongside supplying their continues needs, their esteem wouldn't be marred. Currently, this approach is used at many countries and positive results have emerged. [Mohammad Reza Rezaei, Mehdi Nazarpour and Abbas Emami. **Implications of micro-credit for rural women in developing countries.** Life Science Journal. 2011;8(4):16-20] (ISSN:1097-8135). <http://www.lifesciencesite.com>.

Keywords: micro-credit, rural women

Introduction:

Rural women are among those major groups at society who previously were considered less by planners, due to specific reasons in the past. And this problem is more observable at developing countries. While, by looking at women's history of economic and social life, we can find that this great group, continuously have played basic role in forming economic condition of country. This great group consistent with men have had active role at areas of social-economic activities and always have had major part on economic production of society. Nowadays, supporting family supervisor women is adopted by universal society, as politic, economic a social concern and nearly all countries applied related approaches, and however these efforts have resulted in failure, in so many cases (Banihashem, 1999). paying part of cost of life by government or charities , establishing forums to analyze family supervisor women's problems , supplying necessary facilities to grow and improve child's life quality and paying facilities to provide sustainable employment, are among most important approaches to support family supervisor women . Paying credit facilities to access sustainable employment with easy terms at limited time, is one of the most important approaches to support family supervisor women. Because alongside supplying their continues needs, their esteem wouldn't be marred. Currently, this approach is used at many countries and positive results have emerged. (Ghaffari, 2000).

Aforementioned plan, due to containing special advantage such as giving accessible loan with low commission fee and no interest rate and also long-term repayment, could provide chances for many farmers to release from dealers and broker jobbers. In this approach, giving micro-credits to

rural women seems more effective. because alongside agricultures activities that needed more investments , women by enjoying of very micro-credits not only could create remarkable creativities in rural productions but also gained worthy economic and social abilities , and even improved their field of social presence , well .(Lahsaeizadeh, 2000).

If rural women can work through receiving credits , loan and others finance facilities at favorite jobs and live through earned income (as it called "self-reliance and independence") , so undoubtedly we would see changes in social, economic and cultural relations of village.

Here, Basic issue is that if changes happened following of these events in villages, have positive aspects or negative? Naturally, every change in institutions and social phenomena has both positive and negative dimensions. (Farghdan, 2001).

Being high and low of each one is depended on various conditions and terms so it is varied from one society to another society. In Iranian rural societies, cultural and social context is such that, consequences of these phenomena maybe being different and sometimes contradictory. However these actions caused that women stand in good economic condition and also gain self reliance and rely themselves with no help from husbands, but dominant cultural space on villages may create some disorders. At most of villages in Iran, patriarchal with all features dominate and women's financial self reliance may not being pleasant for some human and rural groups. When women gain financial independence in villages, impacts and social and cultural consequences would emerge. (Chabokru and etal, 2005).

Increasing Suffrage, lack of relying on vast patriarchal families, increasing cultural acknowledgment, relation with newer institutions,

having intellectual independence, making decision for marrying, occupation, emigration and etc are those rights that they gain. gaining aforementioned rights by women in context of cultural and social framework followed some changes that maybe lead to disfunctions and even create disorders and abnormalities at traditional , familial and kinship relations that dominated on villages (Fakhraee 2002).

What that performing credits programs, has made in recent years, was on broad outlook with purpose to access to same results as above findings.

Thus, in one inclusive outlook , it is possible to use micro-credits programs to solve those issues which involved with rural women's economic limitations, so that lead them toward social empowerment, in the context of economic growth (Rahmani andalibi, 2001).

Micro-credits:

The major beneficiaries of micro-credit programs are rural women and low-income groups who use the micro-credits to improve their social and economic status. Bowman (1997) gives a short but clear definition of micro-credit in his book, which is as follows:

“Small, short, collateral-free”; In other words micro-credit means providing small loans without any thing as security for low income people and they'll pay back the loan in a short period of time. (Arab Mazar and Motamed, 2005)

For the past two decades, micro-credit has been one of the solutions considered in order to expedite investment process and strengthen the financial bases in rural and deprived areas. Empowerment and poverty eradication in deprived communities through improving productivity are all results of micro-credit. Micro-credit has proven its value in development as an effective tool in struggling poverty and hunger. It has the ability to change and improve people's lives, especially people in need.

In micro-credit programs there are some other parts like small saving accounts and deposits; that's why they are presented as a credit-saving program (Moazami and et al, 2005).

The two terms in “micro-credit” refer to two fundamental concepts that it is dealing with. The first term “micro” refers to inefficiency of classical economists' development methods. Focus on the term “micro” implies revising the market's economical recommendation in rural development. Small and micro-scale activities are the ones done within the local markets with goal of providing livelihood for households and with least link to the national and international economy. The second term “credit” refers to rural circumstances and lack of official

sources which is a critical problem for them. By designing a micro-credit plan, the system is trying to provide credit sources for poor families and increase efficiency of rural market. In micro-credit system, production is mostly local and industrial, therefore economic surplus in these programs is relatively low. Micro-credit system is widely applied in countries that their national economic program is not capable of creating job and income generating opportunities for the majority of society. (Najafi, 2006).

Micro-credit characteristics:

1- Empowerment

Empowerment is one of the major goals of micro-credit and it's considered as a proper index to evaluate it. Creating self-reliance and self-confidence in people, empowerment is one of the important factors to deal with poverty. It also creates social capacity.

Empowerment plans include:

1. Forming financial groups and creating social capacity
2. Education as a supplementary factor of credit-saving
3. Assigning management of credit plans to members

2- Stability

Stability is a fundamental characteristic for a comprehensive development program and leads to continuance of the program and makes credit-saving plans different from others.

Stability indicators:

- reduce dependence on external financial resources
- reduce trading expenses
- cut the loan subsidies (Banihashem, 1999)

3- Creating and expanding income generating activities

A study conducted by World Bank about micro financial institutions highlights three most frequent goals:

1. Creating employment opportunities for members
2. Increasing vulnerable groups' income and productivities
3. Reduce family's dependence on agriculture in droughts' prone areas

The role of micro-credits in poverty eradication:

The first application of micro-credit was about 20 years ago with the establishment of Grameen Bank in Bangladesh. This bank, providing credit

for the poor (particularly women as 94% of its clients are them), has managed to increase income and economic welfare. Now the program is running in most parts of world especially Asia, Africa and Latin America. One interesting point is that unlike prior perceptions, the poor covered by micro-credit programs has been very successful in paying back their loans.

In the countries that credits are provided in a proper financial manner, not only it has increased production and income but also it has encouraged poor to save a part of their income. These savings can be an important support for the institutes providing micro-credits and can be a financial base for more loans and all these result in institutes' financial dependence.

With the new way of micro-credit payments, in addition to covering poor's financial needs, a combination of other services and facilities are available for them; such as saving accounts, educational services, and cooperation possibilities (Goetz and Sengupta, 2003).

Discussion and conclusion:

Supplying credits and analyzing credits approaches cause opportunity to activate poor men's working power, establishing field for sustainable production and income, prevent usurers and pre shoppers of agriculture productions to plunder poor rural men and finally empowering poor people especially women who can work but were deprived to have capital and work tools, and extension accordance to their activities such as needs assessment, identifying target group, organizing poor people, giving needed specialized and public training and ... have important role on effectiveness and make effective activities of these credits.

Woroniuk, Schalkwyk (1998) at their conducted research believe that now, micro credits, micro finance sources and small business unites are most effective mechanism to decrease poverty.

Plitt and others, conducted research as they called it "do credits programs, can empower women"? Results showed that corporation at credits programs helps empowering women.

Goetz, Sengupta (2003), presented negative image of credits effects on empowering women. They concluded that most women have minimum control on their loans. And when repayment period is short, this shortage of control has devastating effects on women welfare.

Hashemi and others (2004) found that joining to Grameen Bank, has meaningful positive affects on controlling women, and helps to family income.

In researches that conducted by Nanda (2004) became clear that women participation in credits programs had positive affects on their demand about health care.

Fiona Steele and etal (2008) in researches that conducted as called "influences of credits programs on empowering women at Bangladesh", found that women who joined to credits programs, have participated in more educational programs and have married with more educated men and also they have saved more and they had more cash.

Ellen and her colleagues (2009) used approach called it "credits and education at Bolivia, Ghana, Honduras, Mali and Thailand". This approach looks for empowering women through financial services with education. In this approach, women get familiar with importance of credits through education and extension and also familiar with ways to access it through establishing different groups.

Shahnaj and chaudhury(2009) in research as "credits and its role on empowering women" concluded that there is meaningful relation between attending in credits programs and empowering women, at economical dimensions.

Ruhal amin and others (2010) found that those who joined credit funds had more ability rather than those who didn't.

Jameela (2010) presented that credit programs has shown lot of affects on empowering women so that has increased their social, politic and economic ability.

Thus it is obvious that credits programs and its educational and empowering programs can be affective on social, humane and economic development or rural society, if it be associated with proper and gradual practices and base on reciprocal communications principles and apply opinion of local society.

Maybe the main challenges that threaten credits associations, is lack of necessary emphasizes on social dimensions and on reinforcing their basics, that practically cause that this social foundations lose its efficiency soon and practically changed to unsuccessful institution.

In order to overcoming dominant consideration, experts believe that we should consider following in protection process of these social institutions.

- establishing and reinforcing through supporting without ant direct government involvement
- evaluating and constant modifying of financial management mechanisms
- improving organization effectiveness

- establishing constant relation and interaction with similar and equal systems.
- establishing local , regional and national networks
 - establishing support and cover systems in order to decrease risk
 - establishing balance and interaction with financial systems greater decision making include: capital market (local, regional, national) and governmental.

also following suggestions have been offered:

- helping to marketing and establishing many exhibitions for member's productions, credit programs, guiding and training them in line with group and workshop activity, can assist them on economic empowerment.
- since women have pointed to education deficiency as major barrier for empowering them , thus educating rural women at the field of exploiting different credits and channels of receiving credits , and also various educations , is so that lead to enabling them , that contain considerable importance.
- providing extension educations for men in order to believe economic role of their women , and give them chance of corporation on all economic , credits fields
- Since that base of credit association, forms base on People Corporation, so it's good chance to use these communities to expand extension-education activities. so it is better to consider special programs on different extensional filed such as agriculture , ranching , family health , housekeeping economy and other fields accordance to condition of region and rural women's needs .
- it is suggested that vast and exact programming happens at following fields:
 - a- extending insurance, facilities for amenities
 - b- educating women about awareness of their own individual and social rights
 - c- persuading rural women about importance of participating at cooperatives and other educational institutes

d- educating women about job management and income management

***Corresponding Author:**

Mehdi Nazarpour
Marvdasht Branch, Islamic Azad University,
Marvdasht, Iran
E-mail: fereshteh12150@yahoo.com

References:

1. Amiri, S. Female centered sustainable human development. Journal of Agricultural and Development Economics, 2000, No. 9.
2. Arab-Mazar, A. and Jamshidi. M. T. (2005). Article "The role of agricultural banks in financing agricultural micro-credit." Conference on rural development and poverty reduction, agricultural banks, Tehran.
3. Araghzadeh, M. institutions active in the field of providing financial services to rural women. Conference Proceedings rural women micro-credit. (Volume II), 2002. 167-153.
4. Bakhshoodeh M. and Habibullah Salami. Article "The role of agricultural banks in reducing poverty with emphasis on micro-credit." Conference on rural development and poverty reduction, agricultural banks, Tehran, 2005.
5. Balali, L. Mission Trip Reports samples producing rural women (rural women's efforts Affairs Ministry of Agriculture) to India and meeting with the board of directors and senior managers National Bank of Agriculture and Rural Development (NABARD) self-employment Women's Association (SEWA), and the Empowerment Institute rural women (CARE), 2005.
6. Banihashem, F. Rural women, education, association and participation. Jihad Journal village, 14 years, No. 310, 1999, p. 21.
7. Changizi Ashtiani, M .Including the share of women in producing countries. Journal of Agricultural Economics and Development, the third year, special role of women in agriculture. Tehran: Ministry of Agriculture publications, 2003, Pp 83-81.
8. Ellen Vor der Bruegge, Maureen Plas, Christopher Dunford and Kathleen E. Stack. Credit with education: a self-financing way to empower women, 2009.
9. Fakhraee, S. Economic and social effects of their financial reliance of women in rural communities, 2002.
10. FAO. Women in agricultural development. (Translated by: Saleh GH ancestry). Publisher:

- Management studies and studies and promoting people's participation Deputy Agriculture (the former). Pp 46-42, 1998.
11. Fiona Steele, Sajeda Amin and Ruchira T. Naved. The Impact of an Integrated Micro-credit Program on Women's Empowerment and Fertility Behavior in Rural Bangladesh, 2008.
 12. Ghaffari, GH. The role of women and social development. Women's Magazine, 2000, No. 10, p. 15.
 13. Goetz, A. and Rina Sengupta, R. "Who Takes the Credit? Gender, Power, and Control over Loan Use in Rural Credit Programs in Bangladesh." *World Development* 24 (1), 2003, 45-63.
 14. Jameela v. a. Micro credit, empowerment and diversion of loan use, 2010.
 15. Lahsaeizadeh, A. Sociology of rural development. Tehran: Publication Days, 2000, p. 58.
 16. Moazami, M, Rahimi A. and Azam tayefe Heidari. "Coverage and sustainability of micro-credit programs, case study of rural women micro-credit fund" Research Center for Rural Women and Rural Affairs Ministry of Agriculture, 2005.
 17. Najafi. M (2006). Participatory evaluation of rural women micro-credit fund scheme, the organization promoting education and agricultural research.
 18. Nanda. P. (2004). Women's participation in rural credit programs in Bangladesh and their demand for formal health care: is there a positive impact? Center for Health and Gender Equity. USA.
 19. Navab Akbar, F. The role of rural women in the past decade. Journal of Agricultural Economics and Development, conference papers, women participation and Agriculture 1400, Journal No. 3, Publishing Ministry of Agriculture, 1997, P. 186.
 20. Rahmani Andalibi. S. "Need, principles, mechanisms and advantages of micro-credit programs in small business development and improvement of rural women." Conference Proceedings Volume II of rural women micro-credit and promoting people's participation Deputy Ministry of Agriculture - Bureau of Women Affairs in collaboration with Al-Zahra University, Agricultural Bank, Tehran, 2001.
 21. Rahimi, A. Review of micro-credit properties. Conference Proceedings Volume II of rural women micro-credit and promoting people's participation Deputy Ministry of Agriculture - Bureau of Women Affairs in collaboration with Al-Zahra University, Agricultural Bank, Tehran, 2001.
 22. Ruhai Amin, yipping li and ashrad u. Ahmad. Women's credit programs and family planning in rural Bangladesh, 2010.
 23. Saadi. H, Arab Mazar A. Paper "role in accelerating the process of micro-credit in rural development: comparing two perspectives." Conference on rural development and poverty reduction, agricultural banks, Tehran, 2005.
 24. Samadi Afshar, S. Factors affecting rural women's participation in training programs and extension services in agriculture in West Azerbaijan Province 82-81. MSc thesis, Islamic Azad University, Science and Research, 2004.
 25. Shahnaj Praveen and Sajedur Rahman Chaudhury. Micro-credit intervention and its effects on empowerment of rural women: the brac experience, 2009.
 26. Varzgar, sh. and Azizi. M. Evaluation of labor force participation of rural women in cotton production and its related factors in the region and dome of Gorgan, 2001, P. 318.

3/24/2011

**1-4 years old infant's acute diarrhea treatment with zinc sulfate and ORS solution:
A case study at Eshkenan city, Fars province, Iran**

Hakimeh S. Sajjadi¹, Ali Akbar Shaikhi Fini², Abdolvahab S. Samavi²

¹ Hormozgan University of Medical Sciences, Ostandari Blvd, Bandar Abbas, Iran

² University of Hormozgan, Minab Street, Bandar Abbas, Iran

hakimeh.sajjadi@yahoo.com

Abstract: An experiment was conducted to evaluate effects of treatment efficiency of zinc sulfate and ORS solution in combination or with ORS (only) on intensity and duration of diarrhea in 1-4 years old infants. A total of one hundred two of 1-4 years old cases were treated in two groups, control group (52 cases) and experimental group (50 cases). Treatment period were done at health-care center of Eshkenan city, Fars province, Iran. Obtained data were evaluated by t-test for detection of significant difference. Findings showed that zinc sulfate in combination with ORS had better treatment efficiency on shortening of acute diarrhea and lowering its intensity, in comparison with ORS, alone. From the results of this study, it is concluded that zinc sulfate is a suitable complete treatment accompanying with ORS in treating infant's diarrhea term. [Hakimeh S. Sajjadi, Ali Akbar Shaikhi Fini, Abdolvahab S. Samavi. **1-4 years old infant's acute diarrhea treatment with zinc sulfate and ORS solution: A case study at Eshkenan city, Fars province, Iran.** Life Science Journal. 2011;8(4):21-23] (ISSN:1097-8135). <http://www.lifesciencesite.com>.

Key words: 1-4 years old infants; diarrhea; zinc sulfate; ORS solution

1. Introduction

Diarrhea, is a common disorder among infants world widely, and is a major reason of mortality in 1-4 years old in Iran that has a heavy economic costs on public health (King et al., 2003; Zhang and Junling Li, 2009). It is a main agent of grow delay and early mortality in developing countries (Bettger and Odell, 1981). In United States of America 2.1 to 3.7 million diarrhea cases were diagnosed annually and 300-400 cases of annual mortality were recorded because of acute diarrhea (Behrman et al., 2004). Patient with diarrhea causes high economic costs for developing countries, for example about 30 percent of hospital beds in these countries were occupied by diarrhea suffered infants (Prasad, 1998). In Iran, diarrhea is a main reason of mortality for 1-4 years old group (Shams, 2001). In other word, about 12% 1-4 years old of infants in cities and 14% in villages were suffering from diarrhea (Iranian health ministry, 2002). Main reason of diarrhea related mortality is incidence of dehydration that commonly liquid intravenous injection was used for treatment (Arcasoy et al., 1990). In a research it is observed that treatment with only solution injection may cause lowering mortality incidence but can't decline duration of diarrhea period (Richard et al., 1993). Because of negative effect of acute diarrhea on body weight and immune system (Baqui et al., 1993), suggested treatment is including zinc sulfate syrup and ORS solution (Black et al., 1984). Efficiency of this kind of treatment was documented in researches (Reinhold and Charami, 1981; Al-Sonboli et al., 2003). Also, some studies

decelerated that zinc supplementation can prevent respiratory disorders and can help for diarrhea period declining in acute or chronic diarrhea (Bhandari et al., 2002; Behrman et al., 2004; Raqib et al., 2004). With attention to effectiveness of ORS and zinc sulfate treatment, in present study, effect of both of treatments in 1-4 year old infants were compared.

2. Material and methods

This study conducted with clinical based diagnosis on patients (1-4 year old infants) at health-care center of Eshkenan city. The investigable patients have these parameters; 1-4 years old, suffering from diarrhea without hemorrhage and without antibiotic usage from began to end of treatment.

Patients with lower and higher ages (lower than one or higher than four), diarrhea with hemorrhage or without parents allowance were removed from our experimental groups.

Totally, 102 infant were divided in two experimental groups; 52 of them as control group and 50 of them as experimental or treatment group. In control group we had used only ORS and in experimental group, we had used ORS with zinc sulfate syrup according to hospital treatment protocol. Data were collected via communications with patient's parents, documents or disease history review and co-worker doctor's reports in same research project.

Data were analyzed by SPSS Ver. 16 software and t-test was done for comparison of two groups and detection of significant differences.

3. Results

Findings show 27.5 percent of diarrhea suffered infants were boy and 72.5 percent were girl. Age mean of infants was 2.41 years old and around 52.9 percent had lower than two years old. Demographic information of samples is presented as table 1. Diarrhea frequency and duration in control and experimental group are presented in tables 2 and 3. In both of parameters, superiority of experimental group was observed. Statistical analysis for diarrhea intensity show t-value: 11.45 with df: 100 and $p < 0.001$. Also, Statistical analysis for diarrhea duration shows t-value: 7.17 with df: 100 and $p < 0.001$. Comparative statistical description for treatments is presented in table 4.

According to tables 1-4, mean diarrhea frequency after zinc sulfate syrup and ORS was 2.24 time/day that in comparison with control group (4.17 time/day) had considerable declines. For treatment period duration, efficiency of treatment with both of zinc sulfate and ORS in comparison with only ORS, it was observed that mean healing period in experimental group was 2 day that was 3.21 day for control group.

Table 1. Demographic information of studied sample

Traits	Gender			Age (months old)				total
	girl	boy	total	12	13-24	25-36	37-48	
Number	74	28	102	24	30	30	18	102
Percent	72.5	27.5	100	23.5	29.4	29.4	17.6	100

Table 2. Diarrhea intensity (time/day) in control and experimental group

Group	Time	Time					Total
		2	3	4	6	≥ 6	
Control	No.	2	5	32	8	5	52
	%	3.8	9.6	61.5	15.4	9.6	100
Experimental	No.	38	6	6	0	0	50
	%	76	12	12	0	0	100

Table 3. Diarrhea duration (day) in control and experimental group

Group	Day	Day				Total
		1	2	3	≥ 3	
Control	No.	3	8	16	25	52
	%	5.8	15.4	30.8	48.1	100
Experimental	No.	12	29	6	3	50
	%	24	58	12	6	100

Table 4. Comparison of diarrhea duration and intensity of groups via t-test

Trait	group	mean	S.d	t-value	df	significance level
Intensity	control	4.17	0.87	11.45	100	$p < 0.001$
	experimental	2.24	0.82			
Duration	control	3.21	0.91	7.17	100	$p < 0.001$
	experimental	2.00	0.78			

4. Discussion

Findings of present study showed that synchronic application of ORS and zinc sulfate syrup in comparison with only ORS application is more efficient for both treatment parameters (declining of diarrhea frequency and shorting of healing period), qua in control group only 5.8% of infants in first 24 hours and 15.4% in 48 hours of treatment have healing signs, but in experimental group 24% of infants in first 24 hours and 58% of them in 48 hours had healing signs. About diarrhea intensity similar trend was observed; diarrhea frequency was 2 time/day in control group it was 3.8% and in experimental group it was 76%.

Obtained findings were according to past related studies (Sazawal et al., 1997; Dutta et al., 2000). In Sazawal et al. (1997) and Dutta et al. (2000), treatment with zinc sulfate and ORS solution could lower diarrhea intensity and duration and in overall it had healing effect on acute diarrhea in infants. It is concluded, zinc sulfate is a suitable complete treatment for ORS in term of infant's diarrhea treatment.

Acknowledgements:

Authors are grateful to Center of emergency care, Hormozgan University of Medical Sciences, Ostandari Blvd, Bandar Abbas, Iran for financial support to carry out this work.

Corresponding Author:

Dr. Hakimeh S. Sajjadi
Center of emergency care
Hormozgan University of Medical Sciences,
Ostandari Blvd, Bandar Abbas, Iran.
E-mail: hakimeh.sajjadi@yahoo.com

References

- King CK, Glass R, Bresee JS, Duggan C. Managing acute gastroenteritis among children: oral rehydration, maintenance, and nutritional therapy. MMWR Recomm. Rep. 2003; 52(RR-16): 1-16.
- Zhang Z, Junling Li WZ. Study of the risk factors of postoperative upper gastrointestinal bleeding of percutaneous coronary interventional therapy. Life Science Journal. 2009; 6(2): 63 – 64.
- Bettger WJ, Odell BL. A critical physiological role of zinc in the structure and function of biomembranes. Life Science 1981; 28(13): 1425-38.
- Behrman RE, Kliegman RM, Jenson HB, Nelson OS. Textbook of pediatrics. 17th ed. Philadelphia: W.B. Saunders Company; 2004; 169-72.

4. Prasad AS. Zinc deficiency in humans: A neglected problem. *Journal of American Collage of Nutrition* 1998; 17(6):542-543.
5. Shams H. Educational demands of parents about acute diarrhea and application of ORS for fewer than five years old infants at gonabad city. 2001; *OfogeDanesh Magazine*, 2: 55. [In Persian]
6. Iranian health ministry. Health feature. Tabalvor publication, first edition, Tehran, 2002; p: 32.
7. Arcasoy A, Akar N, Ors U, Delibasi L, Karayalcin S. Ultra structural changes in the mucosa of the small intestine in patient with geophagic. *Journal of pediatrics Gastroenterology and Nutrition* 1990; 11:279-282.
8. Richard ZL, Claesonand M, Pierce NF. Manage met of acute diarrhea in children:lessons learned. *Pediatric Infective Disease Journal* 1993; 12(1): 5-9.
9. Baqui AH, Sack RB, Black RE, Chowdhury HR, Yunus M, Siddique AK. Cell- mediated immune deficiency and malnutrition are independent risk factors for persistent diarrhea in Bangladeshi children. *American Journal of Clinical Nutrition* 1993; 58(4): 543-548.
10. Black RE, Brown KH, Becker S. Malnutrition is a determining factor in diarrheal duration/not incidence among young children in a longitudinal study in rural Bangladesh. *American Journal of Clinical Nutrition* 1984; 39(1): 87-94.
11. Reinhold JG, Charami P. An attended study of the effect of Iranian village and urban flat Breads of the mineral balances of two men before and after supplementation with vitamin D. *Ecology, Food and Nutrition* 1981; 10: 169-77.
12. Al-Sonboli N, Gurgel RQ, Shenkin A, Hart CA Cuevas LE. Zinc supplementation in brazilian children with acute diarrhoea. *Annals of Tropical Pediatrics* 2003; 23(1): 3-8.
13. Raqib R, Roy SK, Rahman MJ, Azim T, Ameer SS, Chisti J. Effect of Zinc supplementation on immune and inflammatory responses in pediatric patients with shigellosis. *American Journal of Clinical Nutrition* 2004; 79(3): 444-450.
14. Bhandari N, Bahl R, Taneja S, Substantial TS. Reduction in severe diarrhea morbidity by daily Zinc supplementation in young north indian children. *Pediatrics*. 2002; 109(6): e 86.
15. Sazawal S, Black RE, Jalla S, Mazumdar S, Sinha A, Bhan MK. Effect of zinc supplementation on cell mediate dimmunted and lymphocyte subsets in preschool children. *Indian. Pediatrics* 1997; 34: 589-597.
16. Dutta P, Mitra U, Datta A, Niyogi SK, Dutta S, Manna B. Impact of zinc supplementation in malnourished children with acute watery diarrhea. *Journal of Tropical Pediatrics* 2000; 46(5): 259-263.

3/5/2011

The Investigation and Analysis of Living Ability Level and Its Influencing Factors of Stroke Patients in Community in Zhengzhou, China

Zhang Weihong, Zhang Zhenxiang, Liu Lamei, Lin Beilei, Xie Junfang, Mei Yongxia, Zhang Yaqi

The Nursing College of Zhengzhou University, Zhengzhou, 450052, China.

Zhangzx6666@126.com

[Abstract] objective exploring community stroke patients' living ability level and its influencing factors analysis. **Methods** Investigating 146 cases of community stroke patients' general condition, depression standard and the living ability by using general material questionnaire, self-rating depression scale and Barthel index rating scale. Analyzing the relationship of the ability of life with gender, working condition, year of sick number, the number of stroke and depression, etc. And further regressively probing into the influencing factors. **Results** The living ability of respondents average score are 74.45 ± 31.21 , 73.3% of the respondents can look after themselves basically in their daily life, 26.7% of the respondents have self-care obstacles. The living ability of patients has relationship with working condition, whether having accepted rehabilitation guidance, merger symptoms, merger heart disease, merger diabetes mellitus ($p < 0.05$). Logistic's regression analysis shows that the influencing factors of stroke patients' daily living ability have depression level, whether having accepted rehabilitation guidance and working condition. **Conclusion** The living ability of community stroke patients is in the medium level, which relate to physical, mental and environment, etc, many factors, especially needing to improve their mental state.

[Zhang Weihong, Zhang Zhenxiang, Liu Lamei, Lin Beilei, Xie Junfang, Mei Yongxia, Zhang Yaqi. **The Investigation and Analysis of Living Ability Level and Its Influencing Factors of Stroke Patients in Community in Zhengzhou, China.** Life Science Journal. 2011;8(4):24-29] (ISSN:1097-8135). <http://www.lifesciencesite.com>. #6

[Keywords] Community; Stroke; Activity of daily living; Depression

Stroke is the limitations or the whole brain dysfunction that suddenly happen and caused by cerebrovascular diseases^[1]. The incidence of stroke in Chinese urban and rural areas is 200/100000, the annual death rate is 80/100000 ~ 120/100000, more than 70% of the survivors have different levels of functional obstacle, in which 40% are severe disability. The recurrence rate is as high as 40^[2]. These dysfunctions often lose their daily living skills and the ability to work^[3], reduce patients' social activities participation and impact the quality of their life to a large extent. Therefore, through exploring community stroke patients' living ability level and its influencing factors analysis can increase patients' ability to participate in activities clearly and improve the intervention measures of the quality of life, so that can provide guidance and advice for the development of community nursing work.

1 Object and methods

1.1 objects

Employing convenience sampling method, extracted 146 cases stroke patients, from five communities of Zhengzhou during June to September in 2010. All subjects are up to the diagnosis standard that established in the fourth national cerebrovascular disease academic meeting in 1996, and diagnosed as stroke through the brain CT or MRI. Patients who are

conscious, without dementia and mental disease history, no significant intelligence obstacle and aphasia, stable condition, can understand questionnaire survey and willing to cooperate.

1.2 methods

1.2.1 Survey tools

It is cross-sectional investigative study. Assessing patients' general condition, depression standard and the living ability by using general material questionnaire, self-rating depression scale and Barthel index rating scale^[5].

(1) General material questionnaire: including demographic sociology materials (age, sex, cultural degree, marriage), disease related materials (diagnosis type, merger symptoms, merger disease whether there is a family history), etc.

(2) Self-rating depression scale, SDS: including 20 entries. According to the frequency of occurrence to evaluate each entry, dividing the entry into four levels: 1-"no or little time", 2-"a few time", 3-"quite a lot of time", 4-"most part or all the time". Reverse entries to take reverse graded. Depression serious index = each entire accumulative points / 80 (the highest total). The patients that the score index is below 0.5 are not depressed; the patients that the score index is 0.5 or more are depressed.

(3) Barthel scale index: This scale is a instrument that accepted currently and most common used to assess the living ability of stroke patients, which including ten item content that are shit、urine、dress and making up、going to stool、taking food、shift、walking、walking up and down the stair and bath. According to whether the patients need help or not, the degree of help and the length of time spending of each item, it give each item 15、10、5 or 0 point. The total score are 100 points, the higher the score, the better the self-care independence. According to the score, it divided the living ability into 2 levels. One level that the score are below 60 points the patients are deemed to can look after themselves basically in their daily life, the other that the score are 60 points or more the patients are deemed to have self-care obstacles.

1.2.2 Data collection methods

The investigation team collected questionnaires through the face to face interview type that entering family and visiting. Team members include the undergraduate and graduate students. Only have been unified selection、training、examination, can the investigators participate in study. The study extended 160 questionnaires, retrieved 146 valid questionnaires. The effective recovery rate is 91.2%.

1.2.3 Statistical Methods

By using double people double input method to entry the original data, using SPSS17.0 software to statistic and analysis, using logical check after entry. Using mean、standard deviation、rate, etc, to statistical describe. Using χ^2 inspection、single factor analysis and regression analysis, etc, to do statistical inference.

2 Results

2.1 General Data

The respondents include 93 male patients and 53 female patients. The average age of the respondents are 36 ~ 87 years (67.95 ± 11.08 years). Cultural degree: primary school and the following have 35 cases, junior high school has 49 cases, senior high school or technical secondary school have 44 cases, junior college and above have 18 cases. In which include 119 cases of ischemic stroke, 17 cases of hemorrhagic stroke and 10 cases of mixed stroke. 85 cases of stroke attacked once, 37 cases of twice, 24 cases of three times and more. 53 cases of left hemiplegic, 93 cases of no hemiplegic. 67 cases of merged one kind of disease, 59 cases of merged two or more kinds of diseases. The order of the merged related diseases is high blood pressure (104 cases)、heart disease (48 cases)、diabetes(42 cases), etc.

2.2 The level of living ability of stroke patients

This respondents' averaged Barthel index is 74.45 \pm 31.21 points (0 to 100 points), in which including 107 cases of self-caring basically in their daily life that account for 73.3%; 39 cases of self-caring disabilities that account for 26.7%.

2.3 The analysis of the related factors that influencing the living ability level of stroke patients

2.3.1 The relationship between the living ability level of stroke patients and the general data

Take the patients' gender、culture degree、marital status、duration of illness、the number of stroke、whether merging high blood pressure or not, etc, and living ability to do a chi-square test respectively. The results as described in the table of 1.

2.3.2 The relation between the living ability level of stroke patients and depression

In the study, there are 65 cases of depression patients; the incidence of depression is 44.5%. The score of daily living ability of depression group are 63.62 \pm 35.56 points; the score of no depression group are 83.15 \pm 28.58 points. Take whether having depression or not with the living ability of patients do a chi-square test. The results as described in table 2.

2.3.3 The analysis of the influencing factors of the living ability level

According to the above analytical results ,taking educational level, work status, whether having accepted rehabilitation guidance or not, merge symptoms, whether merging heart disease or not, whether merging diabetes or not and depression as argument, taking living ability as dependent variable. Using Backward method to do Logistic regression, only whether having accepted rehabilitation guidance or not, work status, whether depression or not, brought into the equation. The results as described in table 3.

3 Discussions

3.1 The living ability level of community stroke patients

The rate of disability and fatality of Stroke is very high, and most of the patients left different degree of limbs dysfunction. The studies show that the rate of post-stroke disability as high as 70%, the rate of severe disabilities reach 40%, which seriously influenced the ability of daily living of patients and the ability of social participation. The results of the study show that the stroke patients that can self-care account for 73.3%, although lower than the self-care rate of the aged group (80.6%)^[6], which still shows that the majority of the communities stroke patients can self-care. This may relate to the respondents of the study return to the community in stable condition;

may also relate to the majority of respondents (58.9%) had accepted rehabilitation guidance.

Table 1. The comparison of living ability level in different gender, culture level, whether there is spouse or not, etc. (n=146)

item		Self-care	Self-care	χ^2	P
		basically group	obstacle group		
		cases (%)	cases (%)		
Gender	male	67(72.0)	26(28.0)	0.203	0.653
	female	40(75.5)	13(24.5)		
Culture degree	Primary school and the following	29(82.9)	6(17.1)	3.865	0.046*
	junior high school	37(75.5)	12(24.5)		
	senior high school or technical secondary school	28(66.7)	16(36.7)		
	junior college and above	13(72.2)	5(27.8)		
with or without a spouse	with	90(70.9)	37(29.1)	2.923	0.087
	without	17(89.5)	2(10.5)		
Work condition	continue working	28(90.3)	3(9.7)	5.834	0.016*
	workless	79(68.7)	36(31.3)		
Duration of illness	<1 year	33(71.7)	13(28.3)	1.174	0.556
	1-5 years	43(78.2)	12(21.8)		
	>5 years	31(68.9)	14(31.1)		
The number of stroke	once	67(78.8)	18(21.2)	3.744	0.154
	twice	23(62.2)	14(37.8)		
	Three times and more	17(70.8)	7(29.2)		
Merged symptom	no	27(93.1)	2(6.9)	16.511	0.001**
	One kind	55(78.6)	15(21.4)		
	Two kinds or more	25(53.2)	22(46.8)		
Whether having accepted rehabilitation guidance or not	Yes	72(83.7)	14(16.3)	11.636	0.001**
	No	35(58.3)	25(41.7)		
Have high blood pressure	Yes	79(76.0)	25(24.0)	1.320	0.251
	No	28(66.7)	14(33.3)		
Have hart disease	yes	28(58.3)	20(41.7)	5.135	0.023*
	No	75(76.5)	23(23.5)		
Have diabetes	Yes	22(52.4)	20(47.6)	5.225	0.022*
	No	75(72.1)	29(27.9)		

Note: * represent $P < 0.05$, ** represent $P < 0.01$

Table 2. The comparison of daily living ability between depression group and between non-depressive group (n= 146)

Project		self-care basically	Self-care disorder	χ^2	P
		group	group		
		Number of cases(%)	Number of cases(%)		
Depression	There are	40(61.5)	25(38.5)	8.261	0.004**
	No	67(82.7)	14(17.3)		

Note: * represents $p < 0.05$, ** represents $p < 0.01$

Table 3 The Logistic regression **analysis** of the related influencing factors of the ability of daily living of stroke patients.

	B	Exp(B)	S.E	Wals	P	Nagelkerke R	Goodness of fit
The constant term	7.219	1364.702	1.708	17.867	0.001		
Whether having accepted rehabilitation guidance or not	-1.288	0.276	0.421	9.372	0.002		
Work State	-1.562	0.210	0.680	5.272	0.022		
Depression	-1.081	0.339	0.423	6.523	0.011		
Model evaluation						0.254	73.3%

3.2 The related factors analysis of the living ability level of stroke patients

3.2.1 General demographic data

Studies find that the living ability of the stroke patients that still working is significantly higher than those (including the retired and unemployed) that no work. This may relate to the illness is light of the stroke patients who still working and continuing to work contributes to rehabilitation. Although the stroke patients that no working have more time and effort to participate in exercise, the results of the survey is not ideal, which suggests that we should play the initiative of the community workers and their families members. Creating a certain activity atmosphere to compel stroke patients to participate in exercises in daily lives, and promote them recovery.

In addition, the study shows that gender, educational level have no effects on the ability activity level, which consists with the results of Zhang Hui's, etc, studies [7-8]. The study also finds that whether having spouse or not has no effects on the ability activity level, which disaccords with many researchers' results. Spouse as the caregivers, play an important role of accompanying、guidance and supervision in the recovery procedure of stroke patients. However, in the study, the living ability of the stroke patients who have spouse is lower than those that have no spouse. After the simple interview that with the patients and families members, we found that the patients who have spouse are more easy to idle, most stroke patients reflect that " Don't participate in any activities at home, can't do any things , so don't need to do"; but spouse reflect that "Don't let he do, he do rough-and-tumble which hard to arrange,As I have done for him"; Children reflect that "It is so good that my dad(mamy) being cared of, he(he)will increasingly lazy, don't do any exercise, also don't need to do". Which all show that the traditional concept of care may cause excessive care, excessive reliance on, and thus increases the inertia of stroke patients, which lead to the declining of

enthusiasm for training activities, the reducing of the living ability level; In addition, which may also relate to the size of the sample who don't have spouse is too small.

3.2.2 Disease-related factors

The study shows that the more combined symptoms, the lower ability of living and activities of the patients. Merging symptoms after stroke, on the one hand, will delay the effect of rehabilitation or impede the process of rehabilitation; on the other hand, the more merging symptoms, the more psychological burden of patients, which will produce such as anxiety, depression and other psychological problems. Single factor anglicizing in the study shows that the level of the activity ability of the patients that merged with heart disease, diabetes is lowerer than those that don't. But these factors are not brought into Logistic regression equation in the multivariate **analysis**. This conclusion supports the relation between chronic disease and the living ability level of stroke patients, but couldn't fully support the viewpoint of Lin Hong, etc^[6], proposed that chronic disease will reduce the activity ability of the old people. Merging heart disease can cause the restriction of the scope and strength of patients' activities, which makes the patients are afraid of participating in activities. And the patients that merging diabetes are easy to appear fatigue、polydipsia、polyuria and other phenomenon. In the process of the investigation, a significant number of patients reflect that the frequently going to toilet limits their ability to participate in activities. Therefore, the mechanism of the relationship between merging disease and patients' activities ability deserve to further in-depth discussion.

In addition, the results of the study show that the duration of illness, the number of stroke have nothing to do with the level of the activity ability of stroke patients. Which disaccords with the result of LiuShufang's, etc, studies ^[10],which may relate to

the composite life of illness is long and the condition of the respondents is stable in the study.

3.2.3 Rehabilitation guidance is good to improve the ability of life of stroke patients

This study shows that the ability of self-care of the patients that accept rehabilitation instruction is significantly higher than those who don't accept the rehabilitation intervention. The earlier the intervening of rehabilitation training, the better the recovery of function and the overall effects of the patients^[11]. The Foreign researcher Green^[12] pointed out that stroke patients that received timely rehabilitation training can promote functional remodeling of the central nervous system, and further promote the recovery of limbs' function. If the patients entered into and completed rehabilitation procedure, about 80% of them can exercise or complete exercise independently, 65% ~ 70% of them can do their daily activities by themselves. Thus, it is extremely important of receiving rehabilitation guidance. The study results also show that early rehabilitation training can significantly improve the living ability of stroke patients.

3.2.4 Post-stroke depression can lead to the declining of living ability level

In recent years, domestic and foreign scholars generally realized that the existence of variety mental disorders of stroke patients, especially post-stroke depression. The incidence of depression in the study is 44.5%, which approximates 40~50% that covered by the literature^[13]. The results of the study find that: the living ability level of the stroke patients that have depression is lower theirs that no depression; Taking activity as the dependent variable to do Logistic regression analysis shows that depression is a major influencing factor of the drop of stroke patients' activity level. Foreign Barbara M's, etc,^[14] followed studies find that stroke depression score independently has a negative correlation with the damaged degree of ADL, if mood improved, the recovery of ADL will improve obviously. Domestic LiuYongzhen, ect,^[15] following the depression group 7years find that the Barthel index score of depression group is significantly lower than non-depressed group, which further confirms that depression has a long-time negative influence on the living ability of stroke patients. However WuQingwen, etc,^[16] think that is independent of the ability of stroke patients with depression, depression has nothing with the ability of self-care, which may relate to the different of research tools.

Depression after stroke will weaken the effect of rehabilitation exercise in patients and affect activities of daily living in patients with the involvement and

participation, at the same time on the physiological mechanism of occurrence of depression delay the recovery of neural function of patients with, thereby affecting recovery and improve activities of daily living in patients with.

4 Brief summaries

Post-stroke will cause the declining of activity level of patients, the rate of disability is as high as 70% , which is the corporate result of physical, psychological and social factors and relate to whether the patients have received rehabilitation guidance or not, working state, whether depression or not, merging symptoms, merging heart disease and diabetes mellitus.

Therefor the influencing factors of the rehabilitation of stroke patients are various. Most of the consequences of stroke are nerve damaged than die. As the medical personnel, it is important to the recovery of patients' ability of daily life that knowing the prevention 、 education and guidance of stroke.

Acknowledgements:

The authors would like to acknowledge the work of teacher in the Nursing College of Zhengzhou University who were involved in the collection of the original data.

Corresponding Author:

Dr. Zhang Zhenxiang
The Nursing College of Zhengzhou University
Zhengzhou, 450052, China.
E-mail: Zhangzx6666@126.com

Reference

- [1]Ling Feng editor. Theory and practice of cerebrovascular disease. Beijing: People's medical publishing house, 2006. 23 .
- [2]Nan DengKun editor. Rehabilitation medicine. Beijing: People's medical publishing house, 2008. 158.
- [3] R ö ding J , Glader EL , Malm J , et al. Perceived impaired physical and cognitive functions after stroke in men and women between 18 and 55 years of age--a national survey. Disability Rehabilitation. 2009, 31(13):1092-1099.
- [4] The Fourth National Conference on cerebrovascular disease. Essential points of all kinds of cerebrovascular disease diagnosis. Chinese Journal of Neurology, 1996, 12 (6): 379.
- [5] China Behavioral Medicine Science Editorial Board Editing, the manual of behavioral medicine scale. Beijing: Chinese medical electronic audio-video publishing house, 2005.

- [6] Lin Hong, Zhang Tuohong, Yang Hui, etc. The analysis of the influencing factors on daily living activities of the elder [j]. China health management, 2002, (8): 495-497.
- [7] Zhang Hui, Wu Yi, Hu Yongshan. The analysis of related factors that affecting the prognosis of stroke patients' activities of daily living [j]. Chinese Journal of rehabilitation medicine, 2008, 23(2): 130-131.
- [8] Liu Mingren. The survey the motor function and activities of daily living of stroke patients [j]. Health and wellness, 2009, 115-116.
- [9] Shi Zuorong, Song Jie, Liu Jinfeng. "Empty nest" elder's current situation of activities of daily living and its influencing factors [j]. Nursing Journal of PLA, 2009, 26 (9A): 28-30.
- [10] Liu Shufang, Ni ChaoMin, Han Rui, etc. The related factors that affect the community rehabilitation effect of stroke patients' activities of daily living [j]. Theory and practice of rehabilitation in China, 2007, 13(2): 117-119.
- [11] Sharon K, Paul R, Myrna M, et al. Predictors of functional independence and stress level of stroke survivors at discharge from inpatient rehabilitation. Journal of cardiovascular nursing, 2008, 23(4): 371-377.
- [12] Green JB. Brain reorganization after stroke [J]. Top Stroke Rehabil, 2003, 10 (3) : 1 - 20.
- [13] Whyte EM, Mulsant BH. Post stroke depression: Epidemiology, path physiology, and biological treatment [J]. Bio Psychiatry, 2002, 52(3) : 253-264.
- [14] Barbara M, Gudrun M, Martine J, et al. The perception of emotional facial expressions in stroke patients with and without depression [J]. Acta Neuropsychiatrica, 2007, 19(5): 279-283.
- [15] Liu Yongzhen, Yu FengChun, Yin Jing, etc. Influence of post-stroke depression on the prognosis : 7 years follow-up [j]. Chinese Journal of neurological and psychiatric diseases, 2010, 36(5): 292-295.
- [16] Wu Qingwen, Xing Fengmei, Dong Sheng Lian, etc. The current situation study of the influencing factors on post-stroke depression of community older stroke patients [j]. China health management, 2010, 25(11): 778-779.

8/20/2011

CREB1 Gene Polymorphisms are Associated with Alzheimer's Disease-Related Depression and Antidepressant Response

Lu Zhang¹, Yu Fang², Zhaoshu Zeng³, Yajun Lian¹, Bo Song¹, Yuming Xu¹

¹ Department of Neurology, The First Affiliated Hospital, College of Medicine, Zhengzhou University, Zhengzhou, PR China. ² Key-Disciplines Laboratory Clinical-Medicine Henan, Department of Emergency, The First Affiliated Hospital, Zhengzhou University, Zhengzhou, PR China ³ Department of Legal Medicine, College of Basic Medical Sciences, Zhengzhou University, Zhengzhou, PR China. xuyuming@zzu.edu.cn

Abstract: cAMP response element binding protein (CREB) is needed in the formation of long-term memory and synaptic plasticity. It also promotes synaptic remodeling and modulates the function of many other neurotransmitters. The current study examined potential association between single nucleotide polymorphisms (SNPs) of the CREB1 gene (rs10932201, rs3770704) and Alzheimer's disease-related depression (AD-D). Participants included 336 patients with AD; 128 of these patients had AD-D. Response to 8-week paroxetine treatment was also assessed. The frequency of the rs3770704 C allele was significantly lower in AD-D than in the Alzheimer's disease without depression (AD-nD) patients ($p = 0.0075$ after Bonferroni correction). Carriers of the A allele of rs10932201 responded better to the treatment by paroxetine ($p = 0.0053$). These findings support an important role of CREB1 polymorphism in AD-D.

[Lu Zhang, Yu Fang, Zhaoshu Zeng, Yajun Lian, Bo Song, Yuming Xu. **CREB1 Gene Polymorphisms are Associated with Alzheimer's Disease-Related Depression and Antidepressant Response.** Life Science Journal. 2011;8(4):30-36] (ISSN:1097-8135). <http://www.lifesciencesite.com>. #7.

Keywords: Alzheimer's disease-related depression; cAMP response element binding protein; paroxetine; polymorphism

1. Introduction

Alzheimer's disease (AD) is a neurodegenerative disease characterized by a progressive decline in cognitive function [1]. It is often co morbid with other neuropsychiatric symptoms, most notably depression [2]. Depression occurs in up to 50% of AD patients and has been suggested to contribute to their cognitive impairment [2–4]. Depressive symptoms are related to greater disability in activities of daily life, faster cognitive decline, and a higher frequency of depression and burden in caregivers [5].

Several lines of evidence suggest a link between the cAMP response element binding protein (CREB), a constitutive transcription factor, and depression. The “neurotrophin hypothesis” of depression is based largely on observations that decrease in hippocampal CREB levels are correlated to stress induced depressive behaviors, and that antidepressant treatment enhances the expression of CREB [2,3]. In light of this, Results from studies as well as clinical observation have attempted to identify genetic variations within CREB that may underlie a predisposition to depression.

CREB is a constitutive transcription factor located in the nucleus of eukaryotic organism. It can modulate the transcription of various target genes by binding to the cAMP response elements. CREB is a significant component in the space learning and memory of hippocampus major. Multiple signal transduction pathways converge on CREB, which

plays an essential role in the formation of long-term memory and synaptic plasticity. Long-term memory depends on gene expression mediated by CREB. When it is in the condition of active phosphorylation, CREB in cerebral nerves can activate gene related with long-term memory [6]. CREB is an important protein that transforms short-term memory to long-term memory. It is a key point in the development of long-term learning and memory. So it is called a molecule marker of learning and memory.

The dysfunction of CREB contributes to the neuronal dysfunction and degeneration that occur in aging and aging-associated neurological diseases such as Alzheimer's disease. Pristine symptoms of Alzheimer's disease are the dysfunction of cognition and learning memory. Clinical research discover that CREB activity in the brain mantle and hippocampus is low [7]. The dysfunction of learning and memory in rats concerned with the low express of CREB in the ageing hippocampus [8]. From the exogenous genes obtained from the ageing rats, the expression of CREB in the hippocampus was high, which improved significantly learning and memory in rats through gene transfer with body cell [9,10]. It is thus clear that the reason of dysfunction in learning and memory is the down regulation of CREB in the aging hippocampus.

Therefore, genetic chromosomal localization and function indicate that CREB is the candidate gene in AD-D. The above observations prompted the

present study, aimed at testing the association between different CREB1, the gene encoding CREB, genetic variations, as single loci and multi-locus haplotypes, and the risk to depression in AD patients. The human CREB1 has been mapped to chromosome 2, and a common single nucleotide polymorphism (SNP) has been described. For our purpose, we selected the previously studied HapMap haplotype-tagging single nucleotide polymorphisms, htSNPs is strategy. Approach CREB1 gene mononucleotide polymorphism biological function associated with AD-D in Chinese population.

2. Material and Methods

Study participants

The study was conducted in accordance with local clinical research regulations. Written informed consent was obtained from all participants. Three-hundred and thirty-six AD patients were consecutively recruited from our hospital. The diagnosis of AD was based on Diagnostic and Statistical Manual of Mental Disorders, Fourth Edition (DSM-IV-TR 2000). The diagnosis of depression was established via a half-hour interview with the patients and a proxy interview based on the DSM-IV criteria for major depression. Patients with depressive symptoms at baseline were adequately treated and reevaluated 2 months later. Depressive symptoms were rated by (a) the subsection of the Neuropsychiatric Inventory (NPI) [11], that assesses the presence/absence, frequency and severity of depressive symptoms rated by the caregiver, (b) the 30-item Geriatric Depression Scale (GDS) [12], a self-rating measure of depressive symptoms tailored to elderly individuals, and (c) the 24-item Hamilton Depression Rating Scale (HAMD) [13].

All patients received a general physical checkup and neurological examinations upon recruitment. Participants also received a routine blood test and brain imaging examination (either computed tomography or magnetic resonance). BDNF polymorphism analyses were performed by staff members blinded to patient condition. Global cognitive function assessment was carried out using a set of standardized batteries that included Clinical Dementia Rating Scale (CDR) [14], Mini-mental state examination (MMSE) [15], and Alzheimer's Disease Assessment Scale Instrumental activities of daily living (IADL) [16], and basic activities of daily living index were assessed as well.

Exclusion criteria included: a history of schizophrenia, schizoaffective disorder, delusional disorder or mood disorder with psychotic features, substance use disorder, or mental retardation according to DSM-IV criteria; cerebrovascular disorders, hydrocephalus, or intra-cranial mass as

documented by neuroimaging study within the past 12 months; a history of traumatic brain injury or another neurological disease; abnormalities in serum folate and vitamin B12, syphilis serology, or thyroid hormone levels; or other significant medical problems (e.g., poorly controlled diabetes or hypertension; cancer within the past 5 years; clinically significant hepatic, renal, cardiac or pulmonary disorders); absence of knowledgeable informant who could provide reliable report on patient's behavior.

Treatment

HAMD was used to detect, rate, and quantify treatment response. Subjects who had at least five of the symptoms required by the DSM-IV ($n = 128$) received paroxetine treatment (10 mg/d for 8 weeks). The remaining subjects ($n = 208$) received standard care but no antidepressant. Patient response was assessed at the end of the 8-week treatment. HAMD score at ≤ 7 or a 50% improvement was considered remission.

Haplotype-Tagged SNP identification and selection

To reach enough power to detect small relative risks, we restricted our attention to common SNPs and haplotypes (frequency $\geq 5\%$). We selected htSNPs from the HapMap database (http://hapmap.ncbi.nlm.nih.gov/cgi-perl/gbrowse/hapmap27_B36/) with the Haploview 4.01 program, focusing on the data from Han Chinese Beijing (HCB) samples, including both the upstream and the downstream 3 kb of the gene CREB1, and aiming for a minimum r^2 of 0.8. The selected region was from chr2:208099931 to 208174806 bp. r^2 is a measure of correlation between haplotypes defined by all SNPs and haplotypes defined by the selected htSNPs. The CREB1 gene consisted of only one 58 kb Linkage Disequilibrium (LD) block. Nine common SNPs were tagged by 2 htSNPs: rs10932201 (in perfect LD with rs2253206, rs2254137, rs2551645, rs6740584, rs2551640 and rs11904814, $r^2=1$) and rs3770704 (in absolute LD with rs16839883, $r^2=1$), so the 2 htSNPs were chosen for the subsequent genotyping analysis (Figure 1).

Genotyping

Genomic DNA was extracted from 5-mL peripheral blood samples using standard phenol chloroform protocols. DNA samples were diluted to a concentration of 10 ng/mL and were distributed in 96-well plates.

The genotyping was performed with multiplex PCR and SNP analysis based on Genome Lab SNP stream genotyping platform (Beckman Coulter Inc., Fullerton, CA). The primers for the multiplex PCR and single-base extension reaction (Table 1) were designed for SNP sites by use of web-based software AutoPrimer.com (<http://www.autoprimer.com>). The

SNP stream genotyping assay was performed according to methods previously described by Bell et al [17].

Genotyping was performed in a blind manner so that the performers did not know the case/control status of the subjects. For quality control, a 10% masked random sample of cases and controls was tested by DNA sequencing.

Statistical methods

Allele and genotype frequencies for each individual polymorphism and Hardy-Weinberg equilibrium were evaluated by Chi-square test. Potential association between AD-D and each polymorphism was analyzed using Fisher's exact test or the Pearson Chi-square test. Differences were significant when $p < 0.025$ after Bonferroni correction. These analyses were performed with SPSS 13.0 (SPSS Inc., Chicago, IL, USA). LD and haplotype were analyzed using Haploview 4.01 (<http://www.broad.mit.edu/haploview/haploview>).

3. Results

Demographic and clinical characteristics of the participants are presented in Table 2. Higher NPI, GSD, and HAMD scores were noted in AD-D than that in AD-nD. CDR and IADL did not differ between AD-D and AD-nD patients.

Genotype distribution of the two htSNPs was consistent with the Hardy-Weinberg equilibrium. Genotype distribution, allele frequencies, and statistical analysis of the two htSNPs are listed in Table 3. Genotype distribution and allele frequencies of the CREB1 gene rs3770704 differed significantly between AD-D and AD-nD subjects ($p = 0.0051$ and 0.0075 , respectively). The frequency of the C allele in AD-D subjects was significantly lower than that in the AD-nD ($\chi^2 = 6.99$, $p = 0.0075$, $OR = 0.61$, $95\%CI = 0.42-0.88$).

The rate of remission after paroxetine treatment was significantly lower in the subjects carrying the rs10932201 G allele in AD-D patients ($\chi^2 = 7.98$, $p = 0.0053$, $OR = 0.46$, $95\%CI = 0.26-0.81$) (Table 4).

4. Discussions

AD-related depression is a complex and likely multifactorial trait with important genetic and non-genetic contributing factors. The understanding of genes that underlie susceptibility to depressive symptoms in AD would be a major advance in our understanding of pathophysiological mechanisms and of newer therapeutic approaches.

Depression is one of the most frequent neuropsychiatric comorbidities of AD [18, 19]. AD patients with depressive symptoms have faster cognitive decline and greater disability in daily living [3]. In our sample, 38.1% of the AD patients had

prominent depressive symptoms. Such a rate is consistent with estimates reported by previous studies in other ethnic groups [20, 21]. The present study revealed higher NPI, GDS, and HAMD scores in AD-D, and a strong rank correlation between NPI depression item and GDS.

In the present study, we investigated the genetic correlations of AD-related depression by analyzing sequence polymorphisms within CREB1, which may lead to variations in CREB gene expression or protein metabolism. The most intriguing finding of the current study is the association of CREB1 rs3770704 polymorphism with AD-D. There are a significant excess of allele C in AD-nD compared to the AD-D. We also noted a higher rate of remission after paroxetine treatment in subjects carrying the rs10932201 A allele. To our knowledge, this is the first report of significant association between rs10932201 and treatment response to paroxetine in AD-D.

Previous studies have indicated that CREB1 T allele in rs4675690 is a significant risk to major depression and geriatric depression. CREB1 polymorphism has also been established as a risk factor for AD [22-25]. Results from the current study showed that the association between genotype and allele frequencies of rs3770704 and AD-D also occur in the Chinese population.

Recently, SSRIs have been recommended as the first line treatment for AD-D by many researchers [26, 27]. However, there is a substantial evidence that not all depressed AD patients respond satisfactorily to anti-depressant agents. Previous studies have suggested a link between genetic variation and treatment response to antidepressants. For instance, McCauley and collaborators [28] have reported that the depressed patients with a long form of the SERT gene promoter polymorphism respond better to SSRIs than those with the short form. CREB1 gene has also been found to be associated with response to antidepressant medications. The result of present study supported a role of CREB1 polymorphism in antidepressant response in AD-D patients.

In summary, genetic variation in CREB1 contributes to AD-D by conferring susceptibility or resistance, and responses to antidepressant treatment. Overall, the current study provides further evidence that CREB1 variants play a role in increasing risk for AD-related depression. It is clearly important that independent attempts to replicate this finding are made in large, well-characterized samples in order to establish individual risk profiles of behavioral symptoms in patients with AD, and to further evaluate the complex relationship between CREB1, mood disorders, and neurodegeneration.

Table 1. Primers and Tagged Extension Probes Used for SNP Detection by GenomeLab SNPstream genotyping platform

SNP	Primer	Length of PCR production(bp)	Sequence 5'-3'
rs10932201	Forward (PCRU)	99	AATATTCAATTATTTCCATCTGCG
	Reverse (PCRL)		CTGTCTTCTTTTCAGAGCTGTTATG
	Probe (SNPU)		AGCGATCTGCGAGACCGTATTTCTAGTTTGAAGGTATCTTTCC
rs3770704	Forward (PCRU)	123	AACGGAAAAAGCTTTACCTGA
	Reverse (PCRL)		AAACAGTGTTTTATTTCATCCTGG
	Probe (SNPU)		CGTGCCGCTCGTGATAGAATCTCTCTTTCTAGAACTGAAGAAAT

Table 2. Clinical characteristic in AD-D (n=128) and AD-nD (n=208)

Variable	AD-D	AD-nD
Age(year)	71.51 ± 4. 52	72.50 ± 5. 15
Gender(%)		
Male	32.03(41)	34.13(71)
Female	67.97(87)	65.87(137)
Education(year)	11.46 ± 3. 21	11.73 ± 3. 18
Family history(year)	19(14.84)	33(15.87)
CDR	1.51 ± 0. 98	1.56 ± 1. 09
MMSE	18.72 ± 2. 83	19.51 ± 4. 80
IADL, lost	22.59 ± 5. 16	21.68 ± 5. 28
NPI, total	26.16 ± 15. 14	16.82 ± 14. 52
GDS	23.42 ± 6. 89	15.53 ± 7. 71
HAMD	24.63 ± 5. 81	15.81 ± 5. 91
Hypertension(yes)	39.06(50)	40.87(85)
Cardiomyopathy(yes)	30.47(39)	31.73(66)
Diabetes(yes)	25.78(33)	25.96(54)
Hypercholesterolemia(yes)	21.09(27)	22.12(46)
Apolipoprotein(yes)	26.56(34)	27.88(58)

Note: CDR: Clinical Dementia Rating Scale; MMSE: Minin-Mental State

Examination: ADL: Activities of Daily Living; NPI: Neuropsychiatry Inventory; GDS: Geriatric Depression Scale; HAMD: Hamilton depression rating scale. AD-D compared with AD-nD, differences reaching statistical significance are p<0.01

Table 3 . Frequencies of genotypes and allele frequency of CREB1 htSNPs in AD

SNPs	Genotype	AD-D(%) (N = 128)	AD-nD (N = 208)	OR* (95%CI)	P*
rs3770704	T/T	80 (62.5%)	110 (52.9%)	1	
	C/T	45 (35.2%)	75 (36.1%)	0.83 (0.52-1.32)	
	C/C	3 (2.3%)	23 (11.1%)	0.18 (0.05-0.62)	0.0051
	T allele	205 (80%)	295 (71%)	1	
	C allele	51 (20%)	121 (29%)	0.61 (0.42-0.88)	0.0075
	A/A	64 (50%)	102 (49%)	1	
rs10932201	A/G	51 (39.8%)	95 (45.7%)	0.86 (0.54-1.36)	
	G/G	13 (10.2%)	11 (5.3%)	1.88 (0.80-4.46)	0.2
	A allele	179 (70%)	299 (72%)	1	
	G allele	77 (30%)	117 (28%)	1.10 (0.78-1.55)	0.587417

Note: *AD-D compared with AD-nD, differences reaching statistical significance are p < 0.025.

Table 4. The distribution of CREB1 htSNPs genotype and allele in AD-D responded to paroxetine

SNPs	Genotype	Rp(%) (N =86)	Non-Rp(%) (N = 42)	OR* (95%CI)	P*
rs3770704	T/T	50 (58.1%)	30 (71.4%)	1	
	C/T	34 (39.5%)	11 (26.2%)	1.85 (0.82-4.20)	
	C/C	2 (2.3%)	1 (2.4%)	1.20 (0.10-13.81)	0.32
	T allele	134 (78%)	71 (85%)	1	
	C allele	38 (22%)	13 (15%)	1.55 (0.77-3.10)	0.21
rs10932201	A/A	50 (58.1%)	14 (33.3%)	1	
	A/G	30 (34.9%)	21 (50%)	0.40 (0.18-0.90)	
	G/G	6 (7%)	7 (16.7%)	0.24 (0.07-0.83)	0.021
	A allele	130 (76%)	49 (58%)	1	
	G allele	42 (24%)	35 (42%)	0.46 (0.26-0.81)	0.0053

Note: * Rp group compared with Non-Rp, differences reaching statistical significance are $p < 0.025$

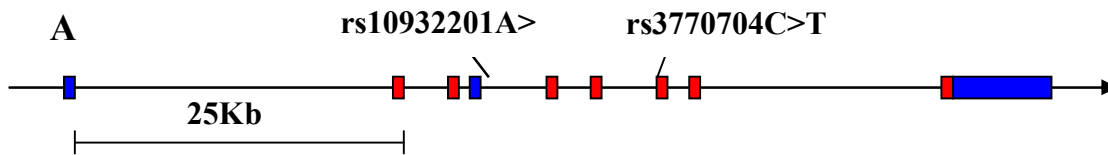

Figure 1. The structure of CREB1 polymorphisms related to the human genomic location and pair-wise linkage disequilibrium analysis

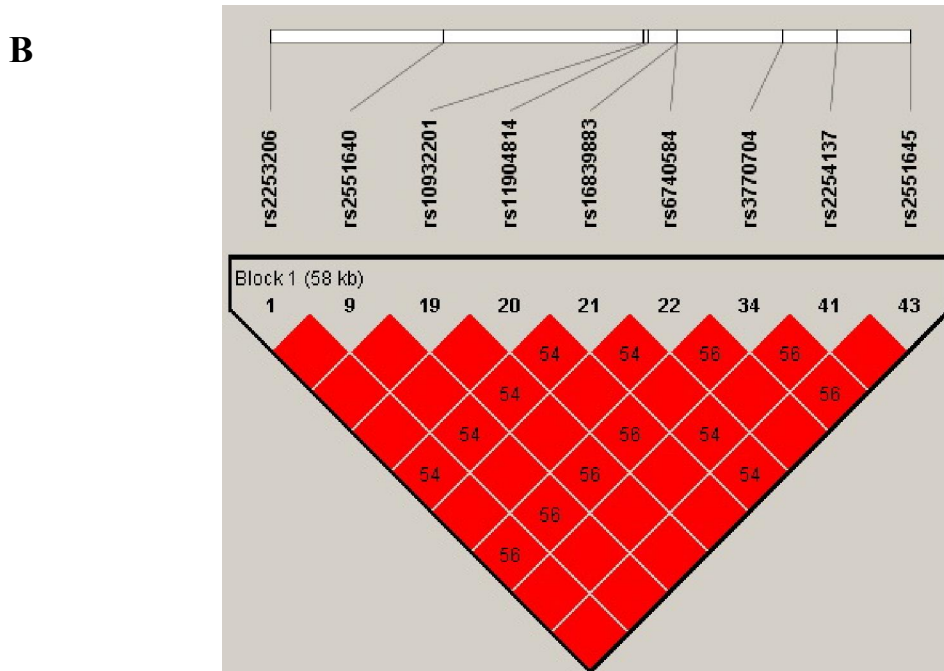

Figure 1. (A) Genomic location of SNPs identified in relation to the exon/intron structure of the human *CREB1* gene. The 9 exons are marked with boxes, in which blue areas represents untranslated regions. Positions for SNPs are relative to the first nucleotide of open reading frame of the *CREB1* gene. **(B)** SNP positions and data on pair-wise linkage disequilibrium were obtained from the HapMap database (HCB sample; http://hapmap.ncbi.nlm.nih.gov/cgi-perl/gbrowse/hapmap27_B36/). Pairwise LD was measured by D' and r^2 . The color boxes correspond to the paired r^2 between the SNPs. (Red boxes $r^2=1$, white boxes $r^2=0$, others = $1 > r^2 > 0$). Squares without a number indicate $D'=1$. 2SNPs in 2 tests captured 9 of 9 (100%) alleles at $r^2 \geq 0.8$. Mean max r^2 is 1.0.

Acknowledgements:

Lu Zhang and Yu Fang contributed equally to this work. This research was partially supported by the National Natural Science Foundation of China (NNSFC) (Grant No. 31071100) and China Postdoctoral Science Foundation (Grant No. 20070420812). The funding sources had input into the design of this study, the collection, analysis and interpretation of data, the writing of the report or the decision to submit the paper for publication.

Corresponding Author:

Dr. Yuming Xu
Department of Neurology
The First Affiliated Hospital, Zhengzhou University
40 Daxuebei Road, Zhengzhou 450052, China
E-mail: xuyuming@zzu.edu.cn

References

1. Wilson RS, Barnes LL, Mendes de Leon CF, Aggarwal NT, Schneider JS, Bach J, Pilat J, Beckett LA, Arnold SE, Evans DA, Bennett DA (2002) Depressive symptoms, cognitive decline, and risk of AD in older persons. *Neurology* 59, 364-370.
2. Modrego PJ (2010) Depression in Alzheimer's Disease. *Pathophysiology, Diagnosis, and Treatment. J Alzheimers Dis* 21, 1077-1087.
3. Lee HB, Lyketsos CG (2003) Depression in Alzheimer's disease: heterogeneity and related issues. *Biol Psychiatry* 54, 353-362.
4. Wilson RS, Mendes De Leon CF, Bennett DA, Bienias JL, EvansDA(2004) Depressive symptoms and cognitive decline in a community population of older persons. *J Neurol Neuro surg Psychiatry* 75, 126-129.
5. Lee HB, Lyketsos CG (2003) Depression in Alzheimer's disease: heterogeneity and related issues. *Biol Psychiatry* 54, 353-362. Smith MD, Wilcox JC, Kelly T, Knapp AK. Dominance not richness determines invasibility of tallgrass prairie. *Oikos* 10, 253-262.
6. Yin JC, Wallach JS, Del Vecchio M, Wilder EL, Zhou H, Quinn WG, Tully T (1994) Induction of a dominant negative CREB transgene specifically blocks long-term memory in *Drosophila*. *Cell*. 79, 49-58
7. Zubenko GS, Hughes HB 3rd, Maher BS (2002) Genetic linkage of region containing the CREB1 gene to depressive disorders in women from families with recurrent, early-onset, major depression. *Am J Med Genet* 114, 980-987.
8. Zubenko GS, Hughes HB 3rd, Stiffler JS (2003) Sequence variation in CREB1 cosegregates with depressive disorders in women. *Mol Psychiatry* 8, 611-618
9. Yamamoto-Sasaki M, Ozawa H, Saito T, Rösler M, Riederer P (1999) Impaired phosphorylation of cyclic AMP response element binding protein in the hippocampus of dementia of the Alzheimer type. *Brain Res* 824, 300-303.
10. Cummings JL, Mega M, Gray K, Rosenberg-Thompson S, Carusi DA, Gornbein J (1994) The Neuropsychiatric Inventory: comprehensive assessment of psychopathology in dementia. *Neurology* 44, 2308-2314.
11. Yesavage JA, Brink TL, Rose TL, Lum O, Huang V, Adey M, Leirer VO (1982) Development and validation of a geriatric depression screening scale: a preliminary report. *J Psychiatr Res* 17, 37-49.
12. Hamilton MA. (1960) A rating scale for depression. *J Neurol Neurosurg Psychiatry* 23, 56-62.
13. Hughes CP, Berg L, Danziger WL, Coben LA, Martin RL (1982) A new clinical scale for the staging of dementia. *Br J Psychiatry* 140, 566-572.
14. Folstein MF, Folstein SE, McHugh PR (1975) "Mini-mental state". A practical method for grading the cognitive state of patients for the clinician. *J Psychiatr Res* 12, 189-198.
15. Lawton MP, Brody EM (1969) Assessment of older people: self-maintaining and instrumental activities of daily living. *Gerontologist* 9, 179-186.
16. Bell PA, Chanturvedi S, Gelfand CA, et al. SNPstream UHT: Ultra-high throughput SNP genotyping for pharmacogenomics and drug discovery. *BioTechniques*. (2003) 34, 496.
17. Weiner MF, Doody RS, Sairam R, Foster B, Liao TY (2002) Prevalence and incidence of major depressive disorder in Alzheimer's disease: findings from two databases. *Dement Geriatr Cogn Disord* 13, 8-12.
18. Zubenko GS, Zubenko WN, McPherson S, Spoor E, Marin B, Farlow MR, Smith GE, Geda YE, Cummings JL, Petersen RC, Sunderland T (2003) A collaborative study of the emergence and clinical features of the major depressive syndrome of Alzheimer's disease. *Am J Psychiatry* 160, 857-866.
19. Borroni B, Archetti S, Costanzi C, Grassi M, Ferrari M, Radeghieri A, Caimi L, Whittaker RH. Evolution and measurement of species diversity. *Taxon* 1972;21:213-51.
20. Caltagirone C, Di Luca M, Padovani A (2009) Role of BDNF Val66Met functional polymorphism in Alzheimer's disease-related depression. *Neurobiol Aging* 30, 1406-1412.

21. Egan MF, Kojima M, Callicott JH, Goldberg TE, Kolachana BS, Bertolino A, Zaitsev E, Gold B, Goldman D, Dean M, Lu B, Weinberger DR (2003) The BDNF val66met polymorphism affects activity-dependent secretion of BDNF and human memory and hippocampal function. *Cell* 112, 257-269.
22. Riemenschneider M, Schwarz S, Wagenpfeil S, Diehl J, Muller U, Forstl H, Kurz A (2002) A polymorphism of the brain-derived neurotrophic factor (BDNF) is associated with Alzheimer's disease in patients lacking the Apolipoprotein E epsilon4 allele. *Mol Psychiatry* 7, 782-785. 495.
23. Ventriglia M, Bocchio Chiavetto L, Benussi L, Binetti G, Zanetti O, Riva MA, Gennarelli M (2002) Association between the BDNF 196 A/G polymorphism and sporadic Alzheimer's disease. *Mol Psychiatry* 7, 136-137. 499.
24. Tsai SJ, Hong CJ, Liu HC, Liu TY, Hsu LE, Lin CH (2004) Association analysis of brain-derived neurotrophic factor Val66Met polymorphisms with Alzheimer's disease and age of onset. *Neuropsychobiology* 49, 10-12.
25. Desai P, Nebes R, DeKosky ST, Kamboh MI (2005) Investigation of the effect of brain-derived neurotrophic factor (BDNF) polymorphisms on the risk of late-onset Alzheimer's disease (AD) and quantitative measures of AD progression. *Neurosci Lett* 379, 229-234. 508.
26. Swartz M, Barak Y, Mirecki I, Naor S, Weizman A (2000) Treating depression in Alzheimer's disease: integration of differing guidelines. *Int Psychogeriatr* 12, 353-358.
27. Lyketsos CG, Lee HB (2004) Diagnosis and treatment of depression in Alzheimer's disease. A practical update for the clinician. *Dement Geriatr Cogn Disord* 17, 55-64.
28. McCauley JL, Olson LM, Dowd M, Amin T, Steele A, Blakely RD, Folstein SE, Haines JL, Sutcliffe JS (2004) Linkage and association analysis at the serotonin transporter (SLC6A4) locus in a rigid-compulsive subset of autism. *Am J Med Genet B Neuropsychiatr Genet* 127B, 104-112.

9/30/2011

Antimicrobial Activities of Gold Nanoparticles against Major Foodborne Pathogens

M. F. Zawrah¹ and Sherein I. Abd El-Moez^{*2}

¹Advanced Material & Nanotechnology Group, Center of Excellence for Advanced Sciences, National Research Center, Dokki, Cairo, Egypt

²Department of Microbiology and Immunology, National Research Centre, Food Risk Analysis Group- Center of Excellence for Advanced Sciences Dokki, Cairo, Egypt.

*shereinabdelmoez@yahoo.com

Abstract: Spherical gold nanoparticles (Au) were chemically prepared and characterized by transmission electron microscope (TEM) and UV spectra. Their antimicrobial activities against major foodborne pathogens were studied. Antimicrobial activities of Au nanoparticles had been increased with their higher volume. Best antifungal activity was observed on using fluconazole coated with 40 μ l Au nanoparticles with zone of inhibition 14mm against *A. niger*, 13mm *C. albicans* and 12mm *A. flavus*. Minimum inhibitory concentration test (MIC) revealed synergistic effect of Au nanoparticles with ciprofloxacin when compared with ciprofloxacin alone. Best results were shown against *S. Typhimurium* (0.097, 0.19), *B. cereus* (0.19, 0.39), *E.coli* O157 (0.39, 0.39), *P. aeruginosa* and *L. monocytogenes* (0.39, 0.78) and finally *S. aureus* (0.78, 6.25) respectively. Gold nanoparticles and fluconazole coated with Au nanoparticles showed variable MIC against *C. albicans*, *A. niger* (6.25, 3.125) and *A. flavus* (12.5, 6.25), respectively. TEM revealed small size of gold nanoparticles (range 9-19 nm) trapped by the biofilm released by *S. Typhimurium* and easily attached to the surface of cell membrane which drastically disturbed its proper function like respiration and permeability. Interaction between *S. Typhimurium* and ciprofloxacin coated with gold nanoparticles revealed that the cell wall was loosened and separated from the membrane or disrupted with complete absence of flagella. TEM of *S. Typhimurium* using ciprofloxacin alone showed intact bacterial cell wall with the accumulation of antibiotic on the cell wall and partial destruction of flagella. Drugs capped gold particle act as a single group against the microorganism which was indicated by using disk diffusion method with increase zone of inhibition of Au alone, ciprofloxacin alone and Au coated ciprofloxacin from 12, 26 and 30 mm, respectively. Also, it was clarified by the decrease in MIC from 6.25, 0.19 to 0.097, respectively. Results indicated that drugs coated with nanoparticles were highly effective against tested isolates so that Au nanoparticles can minimize treatment durations and side effects of drugs.

[M. F. Zawrah and Sherein I. Abd El-Moez **Antimicrobial Activities of Gold Nanoparticles against Major Foodborne Pathogens**] Life Science Journal. 2011;8(4):37-44] (ISSN:1097-8135). <http://www.lifesciencesite.com>.

Keywords: Antimicrobial, gold nanoparticles, foodborne pathogens, ciprofloxacin, *S. Typhimurium*, TEM.

Introduction

Nanotechnology offers unique approaches to control a wide variety of biological and medical processes that occur at nanometer length and it is believed to have a successful impact on biology and medicine (West and Halas 2000; Zandonella, 2003). By controlling the structure precisely at nano scale dimensions, one can control and modify their surface layer for enhanced aqueous solubility, biocompatibility or bio-conjugation. Nanoparticles exhibit attractive properties like high stability and the ability to modify their surface characteristics easily. The basic necessities for drug targeting are that the carrier should be capable of extended circulation in the blood stream; it must be small enough to gain access to target tissues and target cells (Tom *et al.* 2004). Nowadays, research efforts are being concentrated on integrating nanoparticles with biology. It has been reported that antibiotics often disturb the bacterial flora of digestive tract which may develop multiple drug-resistant isolates, hence novel

ways of formulating biocide materials is an upcoming field of attraction (Jarvinen *et al.* 1993; Concannon *et al.* 2003; Altman *et al.* 2006; Daglia *et al.* 2007). For this reason, there is a need for the use of an agent which does not generate resistance and presents a good bactericidal property. Gold nanoparticles have a great bactericidal effect on a several range of microorganisms; its bactericidal effect depends on the size and the shape of the particle (Nirmala and Pandian, 2007). Nanoparticles can act as antibacterial and antifungal agents, due to their ability to interact with microorganisms (Hernandez *et al.* 2008; Dror-Ehre *et al.* 2009; Eby *et al.* 2009; Panacek *et al.* 2009). Exerting their antibacterial properties, nanoparticles attach to the surface of the cell. This interaction causes structural changes and damage, markedly disturbing vital cell functions, such as permeability, causing pits and gaps, depressing the activity of respiratory chain enzymes, and finally leading to cell death (Rai *et al.* 2009; Sharma *et al.* 2009; Li *et al.* 2010). *In vitro* antibacterial activities

of vancomycin protected gold nanoparticles have been reported by (Gu *et al.* 2003).

In the present study, we evaluated the antimicrobial activity of spherical gold nanoparticles against six food poisoning bacteria and three fungal isolates using agar disk diffusion method and MIC. Gold nanoparticles synergistic effect with reference drugs was studied. Also, transmission electron microscopic analysis was used for investigating the interaction of ciprofloxacin, gold nanoparticles and ciprofloxacin coated with nanoparticles with *S. Typhimurium*.

2. Materials and methods

2.1. Synthesis and Characterization of gold nanoparticles

Hydrogen tetrachloroaurate ($\text{HAuCl}_4 \cdot 3\text{H}_2\text{O}$, 99.99%), Cetyltrimethylammonium bromide (CTAB, 99%) and 11-mercaptoundecanoic (MUA) were obtained from Sigma. The other reagents were obtained from Aldrich and were used as received. Ultrapure deionized water was used throughout the experiments. Gold colloids were prepared by citrate thermal reduction method (Yang *et al.* 2005). Typically in the process of thermal reduction, a gold sol was prepared by adding 1ml of 1 wt% HAuCl_4 aqueous solution and 1.5 ml of 38.8mM sodium citrate aqueous solution into 90 ml boiling water. The citrate ion acts as both a reductant and stabilizer. After the solution had turned purple red within 30s, the solution was cooled quickly in the ice bath. This resulted in a stable dispersion of gold particles with an average diameter of around 13.2 nm and 10% polydispersity (Yang *et al.* 2003 and Yang *et al.* 2005). 0.2 ml of 0.1M freshly prepared cetyltrimethyl ammonium bromide aqueous solution was added to 20 ml as prepared gold colloid at room temperature. Finally, 1 ml of 0.5mM MUA aqueous solution was added to the gold colloid modified by 0.1mM CTAB in order to restrain the overmuch aggregation process. The absorption optical spectra of these gold colloids were recorded using Jasco Ubest 570 UV-vis-NIR spectrophotometer. All the spectra were recorded in air at room temperature. The microstructure and morphology of gold nanoparticles in gold colloids was measured with a JEOL-JSGM T1230 transmission electron microscopy (TEM) operating at 200 kV. Those samples were prepared by dropping the colloid onto a carbon coated Cu grid underlying tissue paper, leaving behind a film.

2.2. Preparation of microbial suspensions.

Antimicrobial activities of gold nanoparticles were carried out against common food poisoning isolates. Three Gram positive bacteria (*L.monocytogenes*, *B.cereus* and *S. aureus*), three

Gram negative bacteria (*S. Typhimurium*, *E.coli* O157 and *P. aeruginosa*) and three fungal isolates (*C. albicans*, *A. flavus* and *A. niger*) isolated from food of animal origin were used. Agar disk diffusion method (qualitative) and minimum inhibitory concentration method (quantitative) were used in this study. Wherein a suspension of bacterial and fungal isolates were freshly prepared by inoculating fresh stock culture from each isolate into separate broth tubes, each containing 7ml of Mueller Hinton Broth (Difco) for bacterial isolates and Sabouraud Dextrose broth (Difco) for fungal isolate. The inoculated tubes were incubated at 37°C and 28 °C for 24 hr, respectively. Serial dilutions were carried out for each isolate, dilution matching with 0.5 McFarland was selected for screening of antimicrobial activities. Ciprofloxacin (5µg/ml) and fluconazole (100µg/ml) were used as reference drugs (Oxoid).

2.3. Preparation of drug coated gold nanoparticles (Nirmala and Pandian, 2007).

The drugs coated nanoparticles were prepared as follows; 0.1mM citrate stabilized gold nanoparticles [10 ml of 0.5mM Au diluted to 50 ml] was mixed with 5 ml of 3mM drugs in water and stirred effectively for 2 hrs. This was marked as the control sample. Similarly, antibiotic protected gold were prepared at concentration of gold particles 0.5mM, using different volumes (20 and 40 µl) to study the effect of nanoparticles on the microbial activities.

2.4. Determination of antimicrobial activity by Disk-diffusion method (Nirmala and Pandian 2007; Bansod and Rai 2008).

Mueller Hinton agar plates (Difco) and Mueller-Hinton agar supplemented with 2% glucose and Methylene Blue (0.5 mg/L) were prepared for testing antibacterial and antifungal activities, respectively. The colony forming units of suspension of the tested isolates were determined and tested inoculums were adjusted to 1×10^5 cells/ml, matching with 0.5 McFarland. Inoculums (100µl) were applied on the surface of the agar plates and spread by using sterile glass spreader. For evaluation of antibacterial activities, Whatman no.1 filter paper disks were sterilized and saturated with different volumes of Au nanoparticles; 20, 40 and 50 µl. On the other hand, others were saturated with 50 µl ciprofloxacin (5µg/ml) or with ciprofloxacin mixed with different volumes of gold nanoparticles (20 and 40 µl). The same method was used for evaluation of antifungal activities using fluconazole (100µg/ml) as reference drug using drug coated with Au at volume 40 µl. Disks were placed onto inoculated agar plates and left for 1 hr at 25 °C to allow a period of pre-incubation diffusion in order to minimize the effects of variation

in time between the applications of different solutions. The plates were re-incubated at 37°C and 28°C for 24 hrs for bacterial and fungal isolates respectively. After incubation, plates were observed for antimicrobial activities by determining the diameters of the zones of inhibition for every sample. For an accurate analysis, tests were run in triplicate for each isolate to avoid any error.

2.5. Determination of Minimum Inhibitory Concentration (MIC)

Microtiter dilution plate quantitative method (Andrews, 2001), i.e. the minimum inhibitory concentration (MIC) was used for evaluation of the antimicrobial activity of the gold nanoparticles against inhibited organisms. Determination of MIC of gold nanoparticles against tested isolates was achieved using 96-well sterile micro plates. Initial concentration 100%, then two fold serial dilutions of the nanoparticles and reference drugs (ciprofloxacin or fluconazole) and drugs coated with nanoparticles were inoculated with 100µl of tested isolates (0.5 McFarland, about 1×10^5 cells/ml) and incubated at 37°C-28°C for 24 h for bacterial and fungal isolates respectively. After incubation, plates were examined visually for bacterial or fungal growth precipitation. The experiment was repeated three times. The lowest concentration that showed complete growth inhibition of the microbe was taken as MIC.

2.6. Transmission Electron Microscopy (TEM) examination

S. Typhimurium was subjected to gold nanoparticles, ciprofloxacin and ciprofloxacin coated with gold nanoparticles. The samples were examined using transmission electron microscope (TEM, JOEL JSM-1230). Samples were inoculated in Brain Heart Infusion (BHI) broth then centrifuged at 2100 rpm. Most of the bacterial cells settled at the bottom of the sample vial and the nanoparticles remained suspended in the solution under these centrifugation conditions unless they were bound to the cell walls of the bacterial cells or became large particles as a result of aggregation. The supernatant was then discarded after centrifugation. The remaining bacterial cells conjugated with nanoparticles were washed twice with deionized water (0.5 ml) under gentle vortex mixing for 10 min. The remaining bacterial cells that might be conjugated with the nanoparticles were then resuspended in deionized water (0.5 ml). After gentle vortex mixing for another 10 min, 2µl of this suspension solution was deposited on the copper holder. After drying, the sample was ready for TEM analysis (Ho *et al.* 2004).

3. Results and Discussion

3.1. Characterization of gold nanoparticles

Figure 1 shows TEM image of the obtained gold nanoparticles. As seen in Figure (1), the prepared gold nanoparticles were almost spherical shape, and separated from each other. The particle size is mainly in the range of 11–22 nm. It is also noted that the nanoparticles in the gold nanoclusters were nearly individually isolated.

Figure 2 presents the UV–vis absorption spectra of the prepared gold sols, in which the 530 nm absorption bands were characteristic of the surface plasmon bands of gold nanoparticles of 11–22 nm.

3.2. Agar disks diffusion test

Antimicrobial activities of gold nanoparticles differ according to the volume used and the tested isolates. Antimicrobial activities increased with higher volume; 50 > 40 > 20µl. Au nanoparticles (vol. 50 µl) showed great antimicrobial activities with the best zone of inhibition against *P. aeruginosa* (17mm), *B. cereus*, *L. monocytogenes* (14mm), *S. aureus* (13 mm) and *S. Typhimurium* (12mm) as shown in Figures 3&4.

The best antifungal activity was against *A. niger* and *C. albicans* (12mm each) followed by *A. flavus* (11mm) as shown in Figures 5&6 The antimicrobial ability of Au nanoparticles might be referred to their small size (9-19) nm which is 250 times smaller than a bacterium. This makes them easier to adhere with the cell wall of the microorganisms causing its destruction and leads to the death of the cell. Also, Au nanoparticles are able to maintain their constant shape and size in solution as indicating from Figure (7a). Metal nanoparticles are harmful to bacteria and fungi (Chwalibog *et al.* 2010). Nano-Au stimulate biofilm production and aggregate within this biofilm. They bind closely to the surface of microorganisms causing visible damage to the cells, and demonstrating good self-assembling ability. Gold nanoparticles possess well-developed surface chemistry, chemical stability and appropriate smaller size, which make them easier to interact with the microorganisms (Nirmala and Pandian, 2007). Also, the particles interact with the building elements of the outer membrane and might cause structural changes, degradation and finally cell death. During the interaction between *S.aureus* and gold nanoparticles, they were trapped by the biofilm and the substance released by cells causing distortion of the cell wall (Chwalibog *et al.* 2010). The effect of the ciprofloxacin as antibiotic or ciprofloxacin in combination with 20 and 40 µl Au nanoparticles was studied. It is indicated that the best results were against *S. Typhimurium* with zone of inhibition equal 26, 27 and 30mm), respectively followed by *B. cereus* (23, 24 and 26mm), *P. aeruginosa* (20, 21 and 23mm),

L. monocytogenes (20, 21 and 23mm), *E.coli* O157 (20, 22 and 23mm) and *S. aureus* (11, 12 and 21mm), as shown in Table (1) and Figure (3, 4). By increasing the number of gold atoms, more amount of drug gets adsorbed on the nanoparticle surfaces when the number of drug molecules increase, they act more effectively against the microorganisms. This means that the gold nanoparticles can act as an effective carrier to these drugs (Nirmala and Pandian, 2007).

The antifungal drug coated with Au nanoparticles using different volumes; 40 and 20 μ l was compared with fluconazole. The best antifungal activity was observed on using fluconazole coated with 40 μ l Au nanoparticles with the best zone of inhibition against *A. niger* 14mm, then *C. albicans* 13mm, followed by *A. flavus* 12mm as illustrated in Figures 5&6. The interaction between nanoparticles and fungal cells caused their damage (Nirmala and Pandian, 2007).

3.3. Minimum Inhibitory concentration (MIC)

Au nanoparticles showed variable MIC of bacterial and fungal cultures which differ according to the tested isolates; *P. aeruginosa* (1.56) followed by *B. cereus*, *L. monocytogenes* and *S. aureus* equal (3.125) then *S. Typhimurium* and *E.coli* O157 (6.25). MIC test revealed synergistic effect of Au nanoparticles with ciprofloxacin when compared with ciprofloxacin alone; best results were shown against *S. Typhimurium* (0.097, 0.19), *B. cereus* (0.19, 0.39), *E.coli* O157 (0.39, 0.39), *P. aeruginosa* and *L. monocytogenes* (0.39, 0.78) then *S. aureus* (0.78, 6.25), respectively. Gold nanoparticles and fluconazole coated with Au nanoparticles showed variable MIC against *C. albicans*, *A. niger* (6.25, 3.125), *A. flavus* (12.5, 6.25), as shown in Table (2). Au nanoparticles disintegrated the cell wall and the cytoplasmic membrane of *C. albicans* releasing homogeneous matter then attach to a filamentous substance, excreted from the disrupted cells. Fungicidal activity of Au nanoparticles was due to destroying cell membrane integrity (Chwalibog *et al.* 2010).

3.4. Transmission Electron Microscopy (TEM) Study of Treated Microorganisms

TEM visualization provides an extraordinary opportunity for the morphologic evaluation of ongoing interactions between microorganisms and nanoparticles. Au nanoparticles are stucked randomly with the surface of bacteria. Interaction between *S. Typhimurium* and gold nanoparticles indicates that the nanoparticles were trapped by the biofilm and the substance released by cells with distorted cell wall which might be referred to the thin layer of peptidoglycans found in the cell wall of Gram

negative bacteria. This might be due to the small size of gold nanoparticles (range 9-19 nm) which can easily attach to the surface of cell membrane and drastically disturbed the bacterial proper function like respiration and permeability as shown in Figure (7a). Interaction between *S. Typhimurium* and ciprofloxacin coated with gold nanoparticles revealed that the cell wall is loosened and separated from the membrane or disrupted with complete absence of flagella. Accumulated gold nanoparticles with ciprofloxacin on bacterial cell wall distorted the cells and disintegrated cell wall and cytoplasmic membrane with complete absence of flagella as shown in Figure (7b). TEM of *S. Typhimurium* treated with ciprofloxacin alone exhibited interacted bacterial cell wall with the accumulation of antibiotic on its surface and partial destruction of flagella as shown in Figure (7c&d). The results proved that interaction between Au nanoparticles and *S. Typhimurium* cause damage of parts of the bacterial cell and the flagella which is the organ of motion. Drugs capped gold particle act as a single unit against the microorganism. This led to increase the zone of inhibition from 12 mm (Au), 26 mm (ciprofloxacin) to 30 mm (Au coated ciprofloxacin) using disk diffusion. Also, this was confirmed by the decrease in MIC from 6.25(Au), 0.19 (ciprofloxacin) to 0.097(Au coated ciprofloxacin) as shown in Table (2). Previous study indicated that Au nanoparticles are more effective against Gram negative organisms due to the nature of materials present in cell wall. Gram positive organisms generally have thick mesh like cell wall made of peptidoglycans layer whereas Gram negative organisms possess a thin cell wall with peptidoglycans. Also, TEM images proved easier permeability in Gram negative organisms, which confirms the approach of nanoparticles to the *E. coli* which in turn supports the enhancement of antibacterial activity. Gold nanoparticles act as a good anchor carrying more amounts of drugs on its surface via electrostatic attraction between the amine groups of drugs and nanoparticles which give a better activity of streptomycin protected gold nanoparticles at 0.5mM Au concentration with an increase in the level of zone of inhibition from 82 to 96. Increasing the number of gold atoms, surrounded by a number of drug molecules makes an effective approach of the drug molecules as a group rather than acting alone towards the bacterial organisms (Nirmala and Pandian, 2007). Another studies indicated that drugs capped gold nanoparticles are effective against various isolates of bacteria when compared with the pure drugs. The process of targeting by Au nanoparticles can minimize treatment durations and side effects of drugs (Thomas and Klivanov, 2003; Tkachenko *et al.* 2004; Connor *et al.* 2005 and Mukherjee *et al.* 2007).

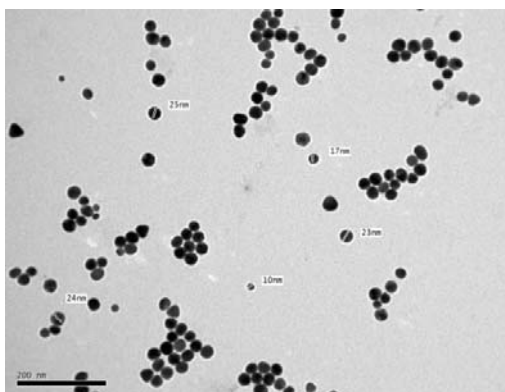

Figure 1: TEM image of gold nanoparticles

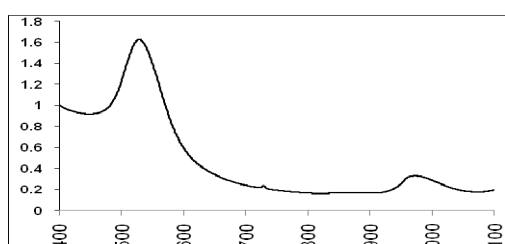

Figure 2: Absorption characteristic of gold nanoparticles

Table (1): Antibacterial activity of spherical gold nanoparticles as compared with ciprofloxacin (5µg/ml) and drugs coated with nanoparticles at different volumes.

Bacterial Isolates	Volume of Au nanoparticles (µl)					ciprofloxacin (5µg/ml)
	20µl	40 µl	50 µl	20 µl Au+ ciprofloxacin	40 µl Au+ ciprofloxacin	
<i>L.monocytogenes</i>	11	12	14	21	23	20
<i>S. aureus</i>	-ve	11	13	12	21	11
<i>B. cereus</i>	12	13	14	24	26	23
<i>S. Typhimurium</i>	10	12	12	27	30	26
<i>E. coli O157</i>	11	12	12	22	23	20
<i>P. aeruginosa</i>	10	16	17	21	23	20

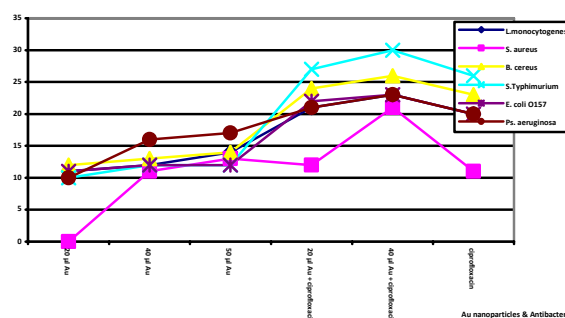

Figure 3: Antibacterial activity of spherical gold nanoparticles as compared with ciprofloxacin (5µg/ml) alone or coated with nanoparticles at different volumes.

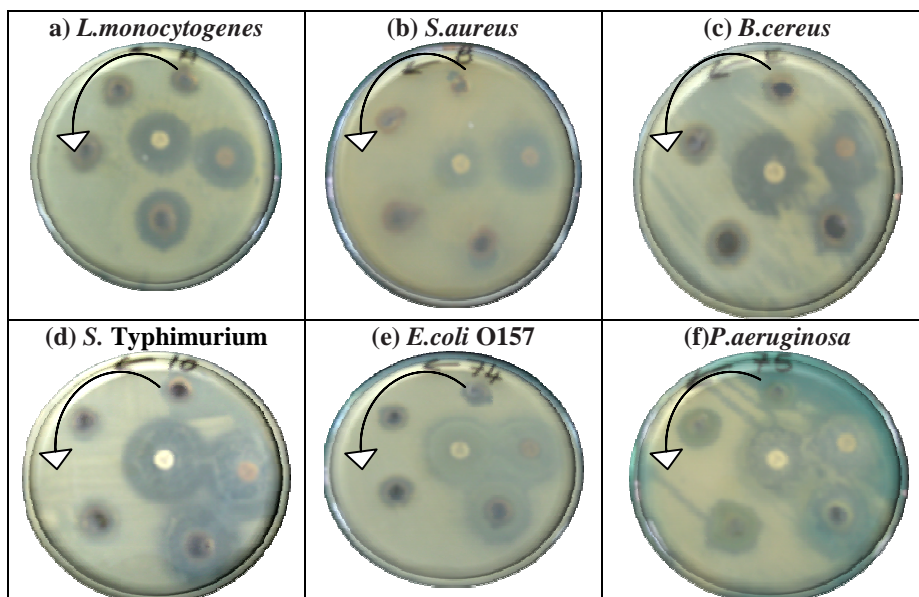

Figure 4: Zones of inhibition of different tested isolates using disk diffusion method showing the antibacterial activity of Au nanoparticle in different volumes; 20 µl, 40 µl, 50µl, (20 µl Au + ciprofloxacin), (40 µl Au + ciprofloxacin) then ciprofloxacin alone, in sequence with the arrow.

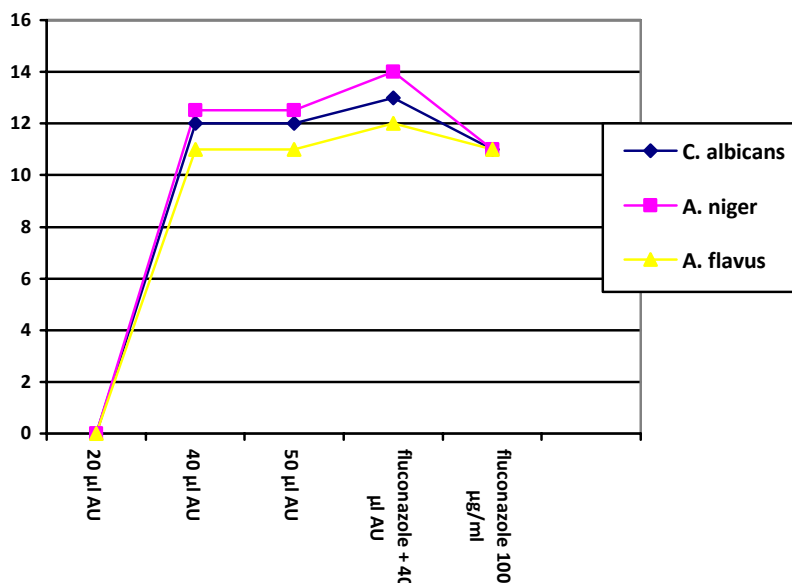

Figure 5: Antifungal activity of spherical gold nanoparticles as compared with fluconazole and drugs coated with nanoparticles at different volumes.

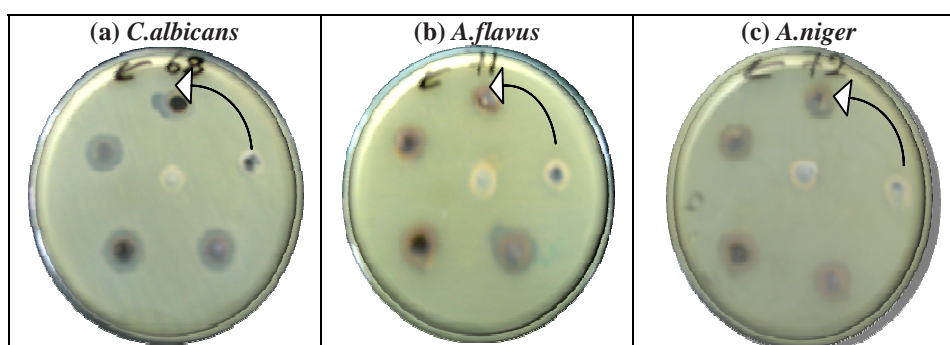

Figure 6: Zones of inhibition of different tested isolates using disk diffusion method showing the antifungal activity of Au nanoparticle in different volumes; 20 μ l, 40 μ l, 50 μ l, 50 μ l fluconazole only, then 40 μ l of Au nanoparticles + fluconazole, in sequence with the arrow. Control negative was at the center.

Table (2): Minimum Inhibitory concentration of gold spherical nanoparticles compared with reference drugs alone and coated with Au nanoparticles.

Isolates	MIC		
	AU nanogold	Reference drugs	Au & reference drugs
<i>L.monocytogenes</i>	3.125	0.78	0.39
<i>S. aureus</i>	3.125	6.25	0.78
<i>B. cereus</i>	3.125	0.39	0.19
<i>S. Typhimurium</i>	6.25	0.19	0.097
<i>E. coli O157</i>	6.25	0.39	0.39
<i>P. aeruginosa</i>	1.56	0.78	0.39
<i>C. albicans</i>	6.25	6.25	3.125
<i>A. niger</i>	6.25	6.25	3.125
<i>A. flavus</i>	12.5	6.25	6.25

Reference drugs: ciprofloxacin (5 μ g/ml), fluconazole (100 μ g/ml).

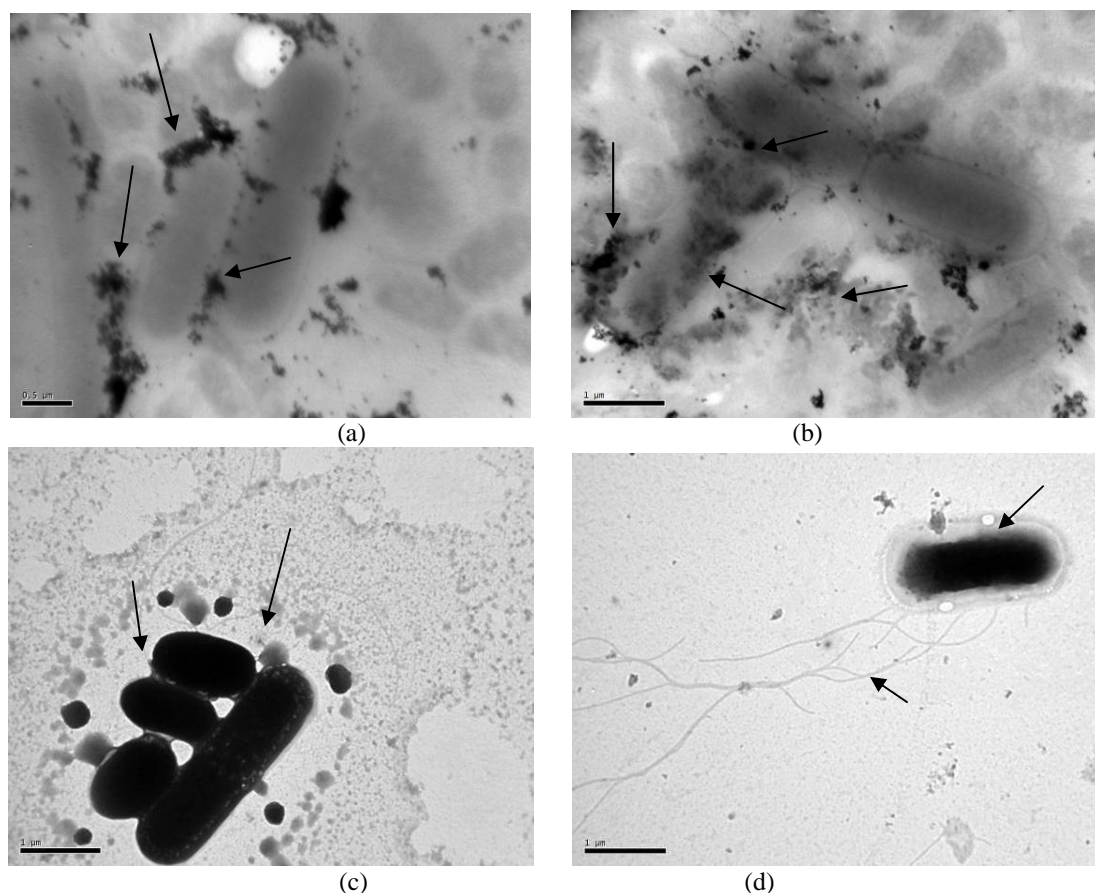

Figure 7: Transmission electron of *S. Typhimurium* treated with (a) Au nanoparticles alone. (b) Ciprofloxacin and Au nanoparticles. (c, d) Ciprofloxacin alone.

Conclusion

Gold nanoparticles are harmful to bacteria and fungi. They bind closely to the surface of the microorganisms causing visible damage to the cells with complete destruction of flagella, stimulate production of biofilm and aggregate within this biofilm. The results verified that drugs coated with gold nanoparticles had more hindrance activities than the pure drugs. They were more effective against Gram negative bacteria due to the thin peptidoglycan layer in the cell wall. Thus the use of Au nanoparticles coated drugs can minimize the treatment durations and side effects of drugs.

Corresponding author
 Sherein I. Abd El-Moez
 Department of Microbiology and Immunology,
 National Research Centre, Food Risk Analysis Group-
 Center of Excellence for Advanced Sciences Dokki,
 Cairo, Egypt.

*shereinabdelmoez@yahoo.com

References

- 1-Altman, H.; Steinberg, D.; Porat, Y.; Mor, A.; Fridman, D.; Friedman, M. et al. (2006): In vitro assessment of antimicrobial peptides. *J Antimicrob Chemother*; 58:198–201.
- 2-Andrews, J. M. (2001): Determination of minimum inhibitory concentrations. *Journal of Antimicrobial Chemotherapy*, 48: 5-16.
- 3- Bansod, S. and Rai, M. (2008): Antifungal Activity of Essential Oils from Indian Medicinal Plants against Human Pathogenic *Aspergillus fumigatus* and *A. niger*. *World Journal of Medical Sciences*, 3 (2): 81-88.
- 4-Chwalibog, A.; Sawosz, E.; Hotowy, A.; Szeliga, J.; Mitura, S.; Mitura, K.; Grodzik, M.; Orłowski, P. and Sokolowska, A. (2010): Visualization of interaction between inorganic nanoparticles and bacteria or fungi. *International Journal of Nanomedicine*; 5: 1085–1094.

- 5-Concannon, S.P.; Crowe, T.D.; Abercrombie, J.J.; Molina, C.M.; Hou, P.; Sukumaran, D.K., et al. (2003): Susceptibility of oral bacteria to an antimicrobial decapeptide. *J Med. Microbiol.*; 52:1083–1093.
- 6-Connor, E.E.; Mwamuka, J.; Gole, A.; Murphy, C.J.; Wyatt, M.D. (2005): Gold nanoparticles are taken up by human cells but do not cause acute cytotoxicity. *Small.*; 1: 325–327.
- 7-Daglia, M.; Papetti, A.; Grisoli, P.; Aceti, C.; Dacarro, C.; Gazzani, G. (2007): Antibacterial activity of red and white wine against oral streptococci. *J. Agric. Food Chem.*; 55: 5038–5042.
- 8-Dror-Ehre, A.; Mamane, H.; Belenkova, T.; Markovich, G.; Adin, A. (2009): Silver nanoparticle – *E. coli* colloidal interaction in water and effect on *E. coli* survival. *J Colloid Interface Sci.*; 339: 521–526.
- 9-Eby, D.M.; Shaublin, N.M.; Farrington, K.E.; Hussain, S.M.; Johnson, G.R. (2009): Lysozyme catalyzes the formation of antimicrobial silver nanoparticles. *ACS Nano.*; 3: 984–994.
- 10-Gu, H. ; Ho, P.L. ; Tong, E.; Wang, L.; Xu, B. (2003): Presenting vancomycin on nanoparticles to enhance antimicrobial activities. *Nano Lett.* 3:1261.
- 11-Hernandez-Sierra, J.F.; Ruiz, F.; Pena, D.C. et al. (2008): The antimicrobial sensitivity of *Streptococcus mutans* to nanoparticles of silver, zinc oxide and gold. *Nanomedicine NBM*; 4:237–240.
- 12-Ho, K.C.; Tsai, P.; Lin, Y. and Chen, Y. (2004): Using Biofunctionalized Nanoparticles To Probe Pathogenic Bacteria. *Anal. Chem.*, 76, 7162–7168.
- 13-Jarvinen, H.; Tenovu, J.; Huovinen, P. (1993): In vitro susceptibility of *Streptococcus mutans* to chlorhexidine and six other antimicrobial agents. *Antimicrob Agents Chemother*; 37(5): 1158–1159.
- 14-Li, W.R.; Xie, X.B.; Shi, Q.S.; Zeng, H.Y.; Ou-Yang, Y.S.; Chen, Y.B.(2010): Antibacterial activity and mechanism of silver nanoparticles on *Escherichia coli*. *Appl Microbiol. Biotechnol.*; 85: 1115–1122.
- 15-Mukherjee P, Bhattacharya R, Bone N, et al. (2007): Potential therapeutic application of gold nanoparticles in B-chronic lymphocytic leukemia (BCLL): Enhancing apoptosis. *J. Nanobiotechnology*; 5:4.
- 16-Nirmala Grace, A.; Pandian, K. (2007): Antibacterial efficacy of aminoglycosidic antibiotics protected gold nanoparticles—A brief study. *Colloids and Surfaces A: Physicochem. Eng. Aspects* 297: 63–70.
- 17-Panacek, A.; Kolar, M.; Vecerova, R., et al. (2009): Antifungal activity of silver nanoparticles against *Candida* spp. *Biomaterials*; 30: 6333–6340.
- 18-Rai, M.; Yadav, A.; Gade, A. (2009): Silver nanoparticles as a new generation of antimicrobials, *Biotechnology Advances*; 27: 76–83.
- 19-Sharma, V.K.; Yngard, R.A.; Lin, Y. (2009): Silver nanoparticles: Green synthesis and their antimicrobial activities. *Adv. Colloid Interface Sci.*; 145:83–96.
- 20-Thomas, M.; Klibanov, A.M. (2003): Conjugation to gold nanoparticles enhances polyethylenimine's transfer of plasmid DNA into mammalian cells. *Proc Natl Acad Sci U S A.*; 100: 9138–9143.
- 21-Tkachenko AG, Xie H, Liu Y, et al. (2004): Cellular trajectories of peptide modified gold particle complexes: Comparison of nuclear localization signals and peptide transduction domains. *Bioconjug Chem.*; 15: 482–490.
- 22-Tom, R.T.; Suryanarayanan, V.; Ganapati Reddy, P.; Baskaran, S.; Pradeep, T. (2004): Ciprofloxacin-Protected Gold Nanoparticles. *Langmuir*; 20:1909-1914.
- 23-West, J.L. and Halas, N.J. (2000): Applications of nanotechnology to biotechnology. *Curr. Opin. Biotech.*; 11: 215.
- 24-Yang, Y.; Hori, M.; Hayakawa, M.; Nogami, M. (2005): Self assembled 3-dimensional arrays of AuSO₂core shell nanoparticles of enhanced optical nonlinearities. *Surf. Sci.*; 579: 215-224.
- 25-Yang, Y.; Nogami, M.; Shi, J.; Chen, H.; Ma, G.; Tang, S. (2005): Enhancement of third-order optical nonlinearities in 3-dimensional films of dielectric shell capped Au composite nanoparticles. *J. Phys. Chem. B*; 109: 4865-4871.
- 26-Yang, Y.; Shi, J.; Chen, H.; Dai, S.; Liu, Y. (2003): Enhanced off-resonance optical ... embedded in BaTiO₃ thin films. *Chem. Phys.; Lett.* 370:1.
- 27-Zandonella, C. (2003): Cell nanotechnology: The tiny toolkit. *Nature*; 423: 10-12.

Childhood Obesity Intervention Programs: A Systematic Review

Mazna A. AlMarzooqi^{*1,2} and M. Christine Nagy²

¹Department of Community Health Sciences, Health Education, College of Applied Medical Sciences, King Saud University, Riyadh, Kingdom of Saudi Arabia

²Department of Public Health, Public Health Education, College of Health and Human Services, Western Kentucky University, Bowling Green, KY 42101, USA

*Corresponding Author's Email: malmazooqi@ksu.edu.sa

Purpose: The purpose of this study was to identify theoretical frameworks that drive childhood obesity prevention programs and identify successful components of childhood preventive intervention programs.

Methods: PubMed and Google Scholar databases was searched for community, school and home settings obesity interventions with anthropometric measures in children and adolescents between the ages of 6 and 12 years from 2004 to 2009. Studies were reviewed by intervention type, duration, outcomes measures and significance of intervention aspects, resulting in a yield of 22 intervention studies. **Results:** The interventions were arranged in ascending order by age group. In total, 22 interventions from around the world were found to tackle the critically important issue of childhood obesity. Among the 22 published studies, ten interventions focused on individual level behavior change and twelve included some nutrition policy changes. With respect to individual behavior, components included cooking classes for families, training on food selection, and health education session on disordered eating. In terms of measurement of behaviors, the majority of the studies (n=22) measured changes in lifestyle. Many of these studies were able to show positive outcome towards progress of healthy behaviors. From the 22 published studies, six interventions relied on secondary prevention while fifteen interventions used a primary prevention method. Only one intervention used both types. Out of 22 published studies, only nine showed significant outcomes. **Conclusions:** Schools are the best settings for childhood obesity interventions because children form libeling eating and physical activity habits at a young age. School-based interventions should focus on childhood obesity prevention. They must target enhancement of physical activity and healthy nutrition in order to decrease BMI. Finally, future interventions should seek to incorporate individual behavior change strategies with policy and environmental changes in order to make a substantial and sustainable impact on children's health and well-being.

[Mazna A. AlMarzooqi and M. Christine Nagy. **Childhood Obesity Intervention Programs: A Systematic Review.** Life Science Journal. 2011; 8(4): 45-60] (ISSN: 1097-8135). <http://www.lifesciencesite.com>.

Keywords: Obesity prevention and control, Physical activity interventions, Health promotion, Elementary school; Childhood obesity.

INTRODUCTION

Childhood obesity has become a global epidemic. Both developed and developing countries face the crisis of rising trends of overweight and obesity among children (Flynn et al., 2004). Ten

percent of school-children worldwide are overweight and in the United States alone, 25% of children are overweight while 11% of them are obese (Sharma, 2007). Table (1) shows the prevalence of obesity in developed countries around the world.

Table 1: Change in the prevalence of obesity rate by year and age group in developed countries around the world (Sharma, 2007).

Country	Year/year range	Age group	Change in Rate of obesity/current rate
Japan	1974-1993	6-14 yrs	5 % to 10%
England	1984-1998	7-14 yrs	8% to 20%
Spain	1985- 1998	6-7 yrs	25% to 35%
France	1992-1996	5-12 yrs	10% to 14%
Australia	1985-1997	6-12 yrs	27%
Greece	1984-2000	6-12 yrs	7% to 12%
Thailand	2000	----yrs	11-14%
New Zealand Pacific	-----	3-7 yr	34-49%

The highest prevalence rates of childhood obesity have been observed in developed countries; however, its prevalence is increasing in developing countries as well. The prevalence of childhood obesity is high in Central and Eastern Europe and pacific

Bases. For instance in 1998, The World Health Organization project monitoring of cardiovascular diseases (MONICA) reported Iran as one of the seven countries with the highest prevalence of childhood obesity at 10 % (Dehghan et al., 2005). This reported

also notes that in Saudi Arabia one in every six children aged 6 to 18 years old is obese. Moreover worldwide, there are proportionately more girls overweight than boys, particularly among adolescents (Dehghan et al., 2005).

Surveys conducted by NHANES (National Health and Nutrition Examination) over the years 1976-1980 and 2003-2006 show that the trend in

childhood obesity has been rising alarmingly. The prevalence of obesity among children aged 2-5 years has increased from 5% to 12.4% in this time period and for the age group 6-11 years, it has increased from 6.5% to 17%. Among adolescents 12-19 years, the prevalence of obesity increased about 12% (5% to 17.6%) (Centers for Disease Control and Prevention [CDC], 2009).

Table 2: Trends in Child and Adolescent Overweight

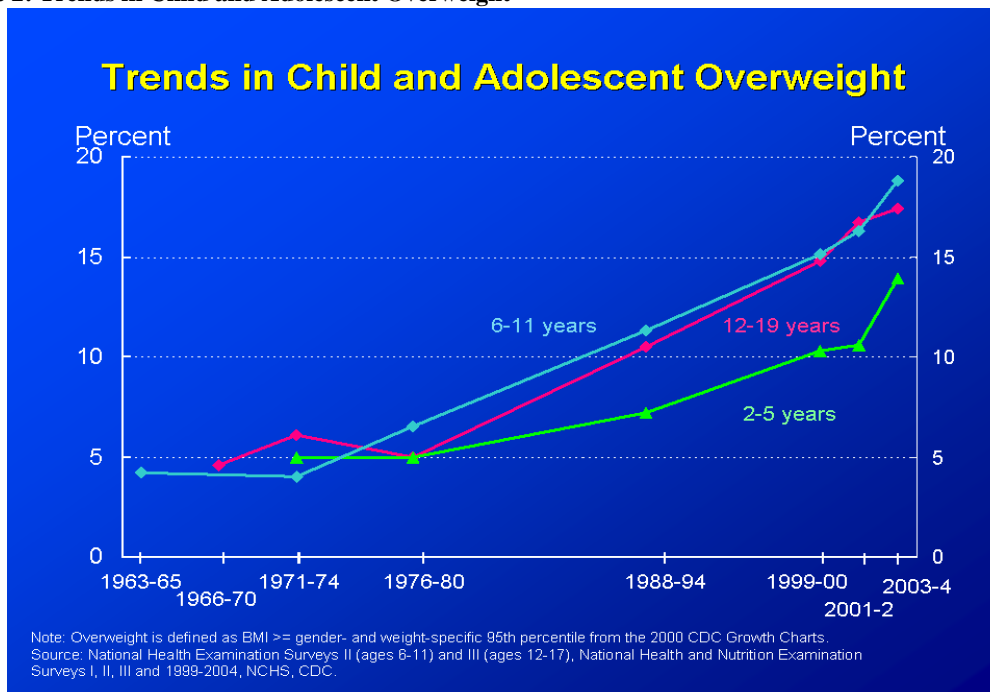

Source: (http://www.cdc.gov/nchs/products/pubs/pubd/hestats/overweight/overweight_child_03.htm)

Childhood obesity is a health condition that has a tendency to continue into adulthood. A study conducted by Whitaker et al., (1997) assessed the link between childhood obesity and the risk of obesity in adulthood. They found that the risk odds ratio for obesity ranged from 1.3 at 1 or 2 years old to 17.5 at 15 to 17 years old.

More than 70% of individuals with a history of childhood obesity grow up to become obese adults (Dehghan et al., 2005). In fact, childhood obesity is not just a disease in itself but in the long term it is responsible for social disabilities and the risk of adult diseases for an individual suffering from it (Flodmark et al., 2005). The most common and highly documented risk of childhood obesity is maturity-onset diabetes in the young (MODY). Sharma (2007) reported that childhood obesity increases the risk of adult obesity, development of metabolic syndrome and MODY by 10 to 30 times. Other related health problems include cardiovascular disease with high blood cholesterol and high blood pressure (Cunnane, 1993). In addition, obese children have abnormal glucose tolerance, digestive disorders and infertility (Sharma, 2007). The childhood obesity epidemic has been projected to result in a decrease in life expectancy of 2-5 years in the 21st century; in what

would be the first decrease in life expectancy since data started being collected in 1900 (Olshansky et al., 2005).

Various factors contribute to overweight and obesity in children. In a literature review by Keller and Stevens (1996), obesity in children was linked to prenatal, genetic, familial and environmental influences. Parents not only contribute genetically but also parental dietary and life-style behaviors critically affect obesity in children (Hodges, 2003).

Obesity means an excess amount of body fat. No general agreement exists on the definition of obesity in children as it does adults. Most professionals use published guidelines based on the body mass index (BMI), or a modified BMI for age, to measure obesity in children. Others define obesity in children as body weight at least 20% higher than a healthy weight for a child of that height, or a body fat percentage above 25% in boys or above 32% in girls (Dehghan et al., 2005). The Center for Disease Control and Prevention defined overweight as at or above the 95th percentile of BMI for age and "at risk for overweight" as between the 85th to 95th percentile of BMI for age. European researchers classified overweight as at or above the 85th percentile and obesity as at or above the 95th percentile of BMI (Sharma, 2007). Waist to hip ratio,

waist-circumference (WC) and skin fold thickness (the sums or ratios of abdominal, subscapular, suprailiac and triceps) and fat mass determined by bioimpedance etc. have also been used to measure obesity (Sharma, 2007).

The body weight of an individual is a result of various factors and the interplays between these factors. Some like the familial, genetic and to some extent, metabolic factors cannot be controlled. Moreover, it is difficult to counteract cultural and socio-economical influences that contribute to obesity. But, the majority of cases involving overweight and obesity are the result of excess calorie/energy consumption and inadequate energy usage i.e., low levels of physical activity and a more sedentary life style (Sharma, 2007). Therefore, any attempts at fighting this growing epidemic of childhood obesity must focus on changing these two behavioral tendencies, that is, reduce energy consumption and increase energy usage (Sharma, 2007).

Obesity takes a toll on the healthcare system as well. Two to six percent and sometimes as high as seven percent of total healthcare costs are spent in combating obesity and obesity related diseases in many of the developed countries. Public Health strategies commonly suggest combating obesity in early childhood. Childhood is considered a priority population for programs because (a) forming good dietary habits and losing weight is easier in childhood than in adulthood and (b) school settings are feasible for group interventions. The emphasis on physical activity and weight stabilization in years of growth is better achieved when the values of health and healthy habits are inculcated during early childhood. Public health strategies suggest combating obesity by interventions aimed at promoting breast feeding, limiting television viewing and involving children in outdoor physical activities. Other interventions have focused on encouraging a balanced diet with more vegetable and fruit intake and at the same time, controlling the portion size and reducing consumption of carbonated and other high calorie soft drinks (Sharma, 2007).

Interventions to fight childhood obesity can be directed at two levels.

In terms of primary prevention, interventions may be targeted or universal. Universal (e.g. school-based interventions) aim at the community level, with the goal of stabilizing or reducing the mean BMI within a population. Selective interventions (e.g. family-based intervention, children of obese parents) target high risk individuals at the interpersonal level. This strategy is concerned with improving the knowledge and skills of individuals to increase competence and personal autonomy and thus prevent excessive weight gain.

1. With respect to secondary prevention, interventions focus on overweight and obese children and seek to prevent further weight gain and/or to reduce body weight (Muller et al., 2005).

2. This study reviewed articles published between 2004 and 2009 that were based on interventions aimed at obesity prevention. The purpose of this study was to identify theoretical frameworks that drive childhood obesity prevention programs and identify successful components of childhood preventive intervention programs. This information will be used to create a profile of successful childhood obesity prevention intervention programs.

METHODS

Research Design

This study is a qualitative research study. A secondary data collection technique was utilized and conducted through a search of articles published between 2004 in PubMed and Google Scholar databases. The criteria for selecting publications for inclusion in the study were as follows:

1. Articles published between 2004 and 2009.
2. An obesity related intervention.
3. Involving children between 6 through 12 years of age.
4. Implementation of the intervention in a community, school and/ or home setting.
5. A content analysis was then conducted based on specific topics: childhood obesity, obesity-related intervention and implementation of the intervention in a community, school and/ or home setting.

Subjects

PubMed and Google Scholar Search Result:

Separate queries were conducted in PubMed and Google Scholar databases. The initial PubMed-based literature query used a cross reference of 5 keyword identifiers including: "obesity prevention and control," "physical activity interventions," "health promotion," "elementary school" and childhood obesity which produced 99 compiled results. A review of the abstracts was conducted utilizing our selection criteria. In total, 18 articles did not address childhood obesity prevention programs nor did they include interventions. Another 11 articles included subjects above the age of 12 or under the age of 6 years. A total of 70 studies from the PubMed search remained for examination. Separately, the Google Scholar -based query used a cross-reference of 4 keyword identifiers as mentioned above and produced 82 compiled results. A review of the abstracts was conducted to further refine the results using the aforementioned inclusion criteria. Excluded were 21 studies that did address childhood obesity intervention programs. As a result, the Google Scholar -based search produced 61 abstracts. PubMed and Google Scholar results were further examined to identify identical intervention studies published under differing titles and time periods. In the end, 22 studies were identified for review by intervention type, duration, outcomes measures and significance of intervention aspects.

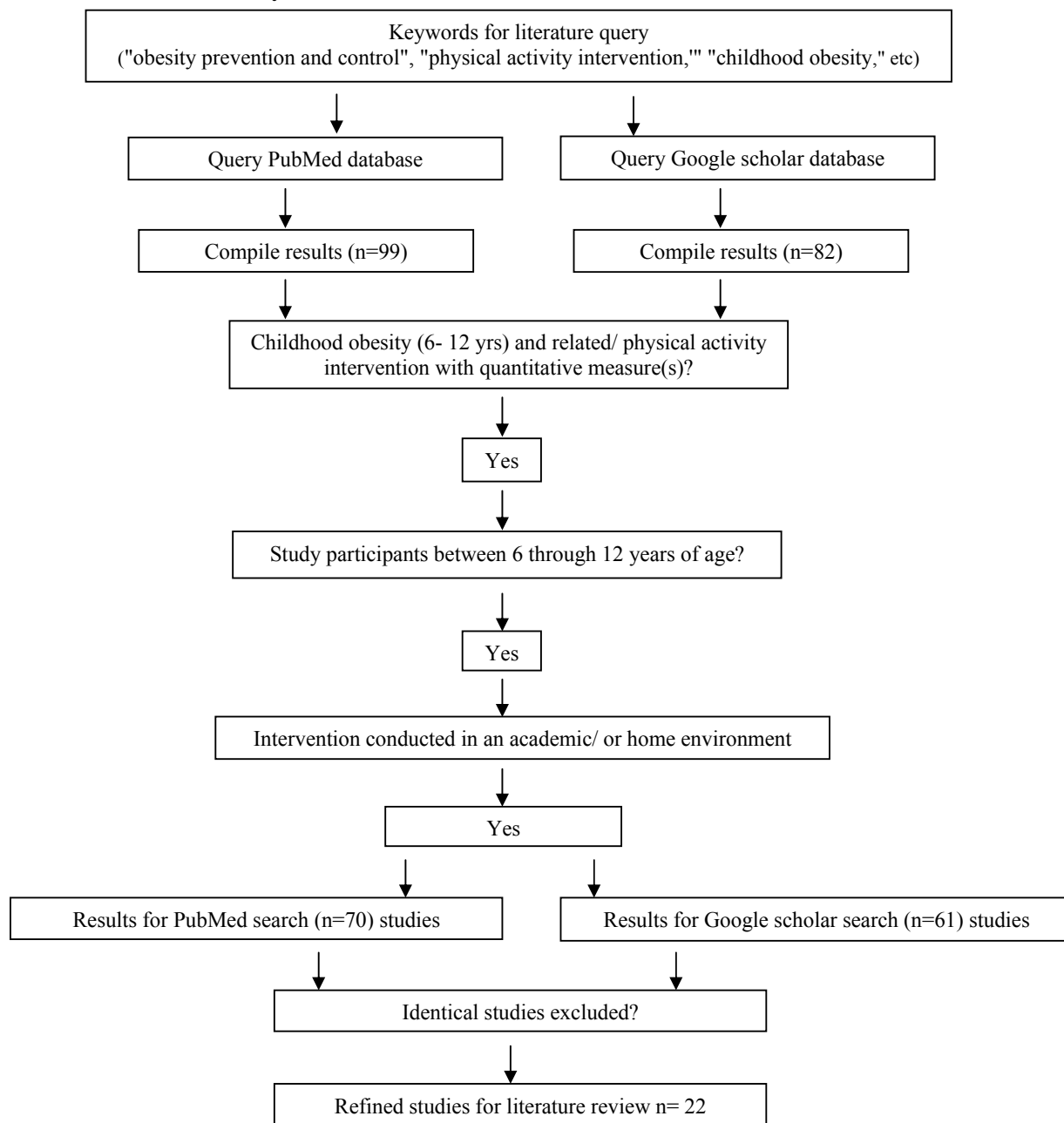
Figure 1: Selection Process for Systematic Review**Instruments**

For this study, interventions aimed at obesity prevention were measured through reviewing articles and categorizing them into 5-year periods by the area of importance.

A data gathering sheet was designed to identify the area of importance of each article. This gathering sheet has nineteen variables as the following:

- 1- Article title.
- 2- Article citation
- 3- Journal title.
- 4- Total number of the target population.
- 5- Participants' age or age group.
- 6- Participants' ethnic race.

- 7- Participants' socio-economic standard (SES).
- 8- Participants' gender.
- 9- Parental involvement in the study- Yes or No.
- 10- Study environment
- 11- Types of prevention
- 12- Study Design
- 13- Description of the intervention
- 14- Intervention Outcome
- 15- Limitation of the study
- 16- Theoretical framework used.
- 17- Dose and duration of the intervention
- 18- Content components of the intervention
- 19- Study outcomes.

Data Collection Procedures

For this study, data were collected through an article review. In the first step, articles that addressed childhood obesity prevention programs were selected. Articles were reviewed to determine whether they focused on our criteria or not. The next step was to abstract information from each article and reports it on the data collection sheet. For data quality assurance, the article review process was conducted twice. This process was used to increase authenticity and accuracy of the systemic review. After these procedures were completed, data were entered into SPSS for data analysis. Frequencies were conducted to identify trend and describe the number of articles focusing on each area under investigation so we could provide a profile of successful childhood obesity prevention intervention programs

RESULTS

The interventions have been arranged in ascending order by age group, and have been summarized in Table 1. The first intervention described is called the *Fit Kids/Fit Families (FKFF)* in children ages 5-16 and their families from Washington County in Wisconsin. Using a non-experimental design, 68 children and their families from Washington County participated in this 12-week program, which promoted healthy lifestyle changes (Joose et al., 2008).

For this intervention, pre- and post data were gathered, on age, height, weight, BMI, body circumference measurements, child and family habits, and child self-esteem. A once-a-week nutrition, physical activities and behavioral log captured behaviors. In addition, two hour meetings using a dietician, behaviorist, and exercise specialist were held weekly in a community setting. At the result, both parents and children showed improved knowledge and attitudes regarding healthy lifestyle changes. Logs

report that 56 % of the children increased their physical activity and 32% reduced their sedentary activity. While 81% improved and 13% maintained BMI, 74% of the children showed decreased total body circumferences. Nearly two-thirds shown clearly enhanced self-esteem on the Rosenberg Self-Esteem Scale (Joose et al., 2008).

The second intervention is called SWITCH, and included a rationale, design, and implementation of a community, school, and family-based intervention. The study districts are found in Lakeville, Minnesota and Cedar Rapids, Iowa. Lakeville is a community of about 50,000 and is the southern-most suburb of Minneapolis- St. Paul. Cedar Rapids, has approximately 125,000 residents and is located in east-central Iowa. There were ten randomly selected schools used while implementing the intervention, which five schools assigned to the control group and the other five assigned to the experimental group. The control and experimental schools corresponded on socio economic status as well as the area of community (Eisenmann et al., 2008).

There were four consecutive phases to SWITCH, and the intervention was based on social ecological model. During the initial phase of SWITCH, each child created a service line with their parent's help, which identified present health behavior exercises as well as measuring feelings and attitudes toward making changes in the main elements (do, view and chew). After families discovered their present exercises they created short term as well as long-term destinations, which fit within their lifestyle (Eisenmann et al., 2008).

The second phase of the program concentrated on establishing additive advancements strengthened by self-rewards. All advancements in behavior in the direction of reaching a self-discovered destination were rewarded with activity points or goal points (Eisenmann et al., 2008).

Table 3: Summary of school-based interventions for prevention of overweight and obesity

Study/ grade/age/ year/ country	Theory	Intervention	Duration	Major findings
Fit Kids/Fit Families (FKFF) K-11 The mean age is 10.4 years (age range, 5-16) Published in 2008 The United State of America	No known theory	Health educational sessions. Create nutrition plan Increase physical activities Behavioral lessons: eating disordered, self care and self esteem.	12-week sessions (3 times per year)	59% of the children increased their physical activity 32% reduced their sedentary activity 81% improved and 13% maintained BMI 74% of the children showed decreased total body circumferences Two-thirds demonstrated improved self-esteem on the Rosenberg Self-Esteem Scale.
SWITCH: rationale, design, and implementation of a community school, and family-based intervention 3rd through 5th grade 8-11 year olds	Social ecological models	Physical activities sessions. Public education/training workshops for parents, teachers, health care providers, religious leaders and business leaders in the	Academic year approximately 8 months.	Enhance children attribute such as knowledge about physical activity and food selections; their values about health, physical.

2005-2006 The United State of America		community at large.		activity, and nutrition; and their sense of personal control over their choice.
Gold Medal Schools Program First, third, and fifth-grade Elementary school students 5-11 year olds 2005-2006 The United State of America	No known theory	Improve eating habits, Increase physical activity Decrease sedentary activity Measure parent perceptions of school nutrition policies.	One year	Children in the Gold Medal Schools group drank fewer soft drinks per day. Gold Medal Schools children walked or biked to school more often at baseline and 1 year.
A Family-based Intervention to promote Healthy Lifestyles in an Aboriginal Community in Canada K-12 5-18 year olds Published in 2007 Canada	The protection motivation theory, the social learning theory, normative influences and theories of persuasion	Behavioral Change: dietary; provision of goods; physical activity. Health education session.	6- month	Changes in daily energy intake & physical activity Changes in knowledge and attitudes toward healthy lifestyles, self/response efficacy, body fat, BMI, abdominal fat, blood pressure, glucose, and lipids.
Evaluation of a classroom-based physical activity promoting program Elementary school students(*) 6-12 year olds 2004-2005 China	No known theory	Increase physical activity: from Moderate to Vigorous range	8-month	Significant increases in the average daily physical activity energy expenditure and duration among the students in the intervention school.
Evaluation of a pilot hospital based community program implementing fitness and nutrition education for overweight children 3rd through 6th grade 8-12 year olds Published in 2008 The United State of America	No known theory	Weekly exercise programs Monthly nutrition education BMI and waist circumference measures Daily diaries Participant completion of food and activity study diaries The wearing of pedometers	24- week	BMI decreased between baseline and weeks 12 and 24. The overall mean waist circumference (inches) also decreased between baseline and weeks 12 and 24.
Physical Activity and Healthy Eating in the After-School Environment 4th through 7th grade 9-13 year olds Published in 2008 The United State of America	No known theory	After-school settings had 4 sessions per day: Academic Enrichment: Moderate and Vigorous Physical Activities (MVPA) Recreational (active and non active) Healthy snack	Academic year approximately 8 months.	Children were spending approximately 47 minutes of after-school time in active recreation, with 49% of this time in organized activities and 51% in free play. The study found that children in an after-school setting were spending significantly more time in MVPA while in free play than when in organized activities.
Outcomes of a group-randomized trial to prevent excess weight gain, reduce screen behaviours and promote physical activity in 10-year-old children: switch-play All grade 5 students 10-11 year olds Published in 2008 Australia	principles from social cognitive theory: self-efficacy and behavioral capability behavioral choice theory: preference, reinforcement	Decrease sedentary behavior Self-monitoring Increasing physical activity Decision-making 'Switch-Play' games Perform advocacy plays	March to November 2002 (Academic year in Australia)	Significant decrease in BMI among those in the combined BM/FMS group compared with the control group.

Policy-Based School Intervention to Prevent Overweight and Obesity 4 th through 5 th grade 11.20-11.13 year old Published in 2008 The United State of America	No known theory	School self-assessment Nutrition education Nutrition policy Social marketing Parent outreach Measure dietary Intake Increase physical activity Decrease sedentary behavior	9- month	Significant decrease in BMI Significant increases in the average daily physical activity energy expenditure and duration among the students in the intervention school Changes in knowledge and attitudes toward healthy lifestyles Enhance parent and children values about health, physical activity, and nutrition.
Preliminary Findings from an Evaluation of the USDA Fresh Fruit and Vegetable Program in Wisconsin Schools 4 th , 7 th , and 9 th grade 11-15 year old 2006-2007 The United State of America	No known theory	Try new fruit at school Try new vegetable at school Try new fruit at home Try new vegetable at home Choose fruit as snack instead of chips/candy Choose vegetable as snack instead of chips/candy	3 months of program implementation	40% indicated they would choose a fruit Only 21% would choose a vegetable. 33.8% of students said they would try a new vegetable. At home 55.6% of students indicated they would try a new fruit and 32.9% said they would try a new vegetable. Students were more willing to eat fruits than vegetables and also more willing to try both fruits than vegetables at home versus at school. There was significant opportunity for students to move in a positive direction from either "would not" or "might" in terms of willingness eat fruits and vegetables.
Preventing childhood obesity: two year follow-up results from the Christchurch obesity prevention programme in schools (CHOPPS) 2 nd - 5 th grade 7-11 year old 2001 The United Kingdom	No known theory	To discourage the consumption of "fizzy" drinks (sweetened and unsweetened) with positive affirmation of a balanced healthy diet One hour of health education session Improve overall wellbeing and reducing the consumption of diet carbonated drinks so they would benefit dental health.	12- month school based intervention 3-year follow-up	There was no significant difference in the baseline z scores between children in the control and intervention groups who were present or missing at the final measurements.
Increasing activity and improving nutrition through a schools-based programme: Project Energize. Design, programme, randomisation and evaluation methodology 1 st - 4 th grade 5 -10 years old Published in 2008 New Zealand	No known theory	Physical activity Nutritional diet Dental health care	2- year	Reduced sedentary time Increased children's activity levels Improved dental health Improved body composition.

<p>Healthy Buddies: A Novel, Peer-Led Health Promotion Program for the Prevention of Obesity and Eating Disorders in Children in Elementary School K- 7th grade 5-13 year old Published in 2007 Canada</p>	<p>No known theory <u>Note:</u> The study used the role model and self-esteem as a component in their intervention</p>	<p>Regular Physical Activity: Aerobic fitness sessions Healthy Eating: Students learned about nutritious and non-nutritious foods and beverages. Healthy Body Image, Self-esteem, and Social Responsibility: Addressed body-image and disordered eating issues</p>	<p>10-month (Academic year)</p>	<p>Increased health knowledge, health behaviors, and health attitudes in children Increased physical activities.</p>
<p>Reducing unhealthy weight gain in children through community capacity-building: results of a quasi-experimental intervention program, Be Active Eat Well K- 6th grade 4-12 year old 2003-2006 Australia</p>	<p>No known theory</p>	<p>Nutrition strategies Physical activity Reduce screen time</p>	<p>3-year</p>	<p>The program was effective at slowing the rate of weight gain (by about 1 kg) and waist gain (about 3 cm) in primary school-aged children, in a manner that was safe. They saw some evidence of this upstream impact through reduction in the social gradient with weight gain, and this implies that community-wide interventions should not increase health inequalities in relation to child overweight.</p>
<p>YMCA Program for Childhood Obesity: A Case Series K- 8th grade 3.6-14 year old 2007 The United State of America</p>	<p>No known theory</p>	<p>Group counseling Nutrition education Physical activity Gift card incentives</p>	<p>6-month</p>	<p>15 of the 35 active participants (43%) experienced a clinically significant change in weight gain compared with controls Results suggest that community programs can be successful in addressing the problem of childhood obesity in families that are motivated.</p>
<p>L.I.F.E.: A School-Based Heart-Health Screening and Intervention Program 5th grade 10 year old Published in 2008 The United State of America</p>	<p>Hierarchy of needs Social cognitive theory Ecological perspective Health belief model Stages of change PRECEDE-PROCEED</p>	<p>Awareness/knowledge tactics Pedometers for teachers Teacher training for e-learning unit HealthyHearts4Kids Incentive-based programs Family-based walking/physical activity programs No-TV week Parent-child cooking classes</p>	<p>3-year</p>	<p>Increased physical activity and healthy nutrition choices A team approach within the school setting, with families and community partners, is essential in addressing current and future health concerns of today's youth.</p>
<p>Louisiana (LA) Health: Design and methods for a childhood obesity prevention program in rural schools 4th-6th grade 8-12 year old Published in 2008 The United State of America</p>	<p>Social Learning Theory</p>	<p>Healthy diet promotion. Physical activity promotion Program for families Classroom curriculum Internet counseling and education</p>	<p>3-year</p>	<p>Policy decisions are made by a five-person committee that includes scientists and community and state education leaders. Also, recruitment goals for the randomized controlled trial (RCT) and observation control group were met.</p>

<p>Pilot Study of an Individually Tailored Educational Program by Mail to promote Healthy Weight in Chinese American Children 3rd-5th grade 8-10 year old 2005-2006 The United State of America</p>	<p>Ecological Model- Ecological System Theory (EST)</p>	<p>Knowledge related to children's dietary and physical activity Classes for food choices</p>	<p>One year</p>	<p>The discrepancies seen in the children's and mothers' levels of knowledge are not well understood. It is possible that children learned knowledge regarding physical activity and nutrition at school or through media because there has been a lot of attention given to childhood obesity prevention. Although mothers were asked to share the information with their children, it is uncertain whether they shared the information.</p>
<p>Reducing weight gain in children through enhancing physical activity and nutrition: the APPLE project 1st-6th grade 5-12 year old Published in 2006 New Zealand</p>	<p>No known theory</p>	<p>Increasing physical activity Increasing the intake of fruit and vegetables Reducing the intake of sugary drinks Curricular-based activities Provision of cooled water filters in each school</p>	<p>2-year</p>	<p>Intervention children were spending on average 26 more minutes per day in activities of a moderate or vigorous nature than control children The mean BMI <i>Z score</i> was significantly lower in intervention children than in control children by 0.09 after 1 y and 0.26 at 2 y. Waist circumference was also significantly lower at 2 y in intervention children (1.0 cm), and systolic blood pressure was lower at 1 year, although this was no longer significant at 2 y.</p>
<p>Two-year follow-up of an Obesity prevention initiative in children: the APPLE project 1st-6th grade 5-12 year old Published in 2008 New Zealand</p>	<p>No known theory</p>	<p>Increasing physical activity Increasing the intake of fruit and vegetables Reducing the intake of sugary drinks Curricular-based activities Provision of cooled water filters in each school</p>	<p>2-year</p>	<p>Reduced the risk of excessive weight gain in children. Enhanced extracurricular physical activity (during and after the end of the school day). Promoted healthy eating to pupils, and teachers The mean BMI <i>Z score</i> was significantly lower in intervention children than in control children.</p>

<p>Family-Based Weight Management with Latino Mothers and Children 2nd- 11th grade 6-17 year old Published in 2008 The United State of America</p>	<p>No known theory</p>	<p>Workbooks weekly reading assignments, goal setting, and evaluation. Chapter content focuses on nutrition, behavioral change, activity, increased speaking up, and improving parenting skills Families established individual behavioral goals for nutrition, physical activity, and family support Increase daily activity (e.g., play for 60 min on most days) and decrease inactivity (e.g., less TV, computer, and/or video games)</p>	<p>8-week</p>	<p>The majority of the mothers (84.6%) endorsed the idea that they can influence their child's food choices. The mothers also felt they were able to influence physical activity levels (92.3%). These mothers had a strong concern about their children's weight (71%); and the mothers seemed to understand the likelihood that remaining overweight would lead to increased risk for diseases associated with obesity (71%). Additionally, the mothers agreed that their own exercise and eating habits could influence their children's (69%). Seventy-eight percent of the mothers intended to get 30 min of physical exercise at least 5 days per week, with more than 20% indicating they already did this.</p>
<p>Walking the Talk: Fit WIC Wellness Programs Improve Self-Efficacy in Pediatric Obesity Prevention Counseling 51 WIC's staff members 34-45 year old Published in 2004 The United State of America</p>	<p>No known theory</p>	<p>Increase consumption of fresh fruit or vegetables Increase physical activity Increase daily consumption of water</p>	<p>One year</p>	<p>The Fit WIC experience illustrates that supporting staff in achieving their own healthy eating and physical activity goals significantly increases staff commitment and enthusiasm for addressing healthful behavior patterns with clients in the WIC setting. Staff participating in Fit WIC achieved a high degree of personal satisfaction and felt more skilled in communicating about nutrition and physical activity with WIC clients.</p>

The third phase of the program was designed to make it easier for families to plan healthy snacks and healthy meals that included vegetables and fruits, by supplying mealtime as well as shopping planners (Eisenmann et al., 2008).

The fourth phase of the program concentrated on the upkeep of each family's healthy behavior over the period of 8 months. This intervention made it possible to improve children's knowledge regarding selection of foods, physical activities, and nutrition. This program also facilitated children's goal-setting as well as self-monitoring to improve their current habits, in addition, it proposed ways of strengthening their intention to advance healthy behaviors for their families as well as themselves (Eisenmann et al., 2008).

The third intervention was the Gold Medal Schools Program. This study took place at four schools in Tooele County, Utah that served as either intervention or control sites. Every student in the first, third, and fifth grades and their parents were given study packets containing a study letter, parental consent form and parent survey. Parents completed consent forms and surveys. Anthropometric information was collected for every student who was contributing to the survey, but only third- and fifth- grade pupils finished the survey. The parent surveys showed at year one that children in the Gold Medal Schools group drank fewer soft drinks daily (Jordan et al., 2009). Furthermore, variations in dietary habits showed significant differences between the intervention and control groups at year one. Parent surveys also showed that Gold Medal Schools' children increased their

physical activity by walking or biking to school more often at baseline and one year. Finally, longitudinal investigations were suggested to assess the long-term influence of Gold Medal Schools on anthropometric, dietary, sedentary behavior and personal activity (Jordan et al., 2009).

The fourth intervention was a Canadian family-based intervention to promote healthy lifestyles which was published in 2007. Kindergarten to 12-grade students from 50 households were recruited. This study's design was open randomized controlled trial. The intervention was based on protection motivation theory, social learning theory, normative influences and theories of persuasion. Further, this study included an intervention that was made up of several components. The first component was health messaging/education about healthy lifestyles mediated by a key messenger referred to the "health counselor". The second component was physical activity goals, which increase the daily physical activity of all members to a minimum of 150 minutes/week. The last component emphasized increased intake of water or low-fat milk as the usual beverage of choice, as a replacement for soda pop and fruit juices. This was selected as a key component of the intervention. Families participated in a 30-minute introductory meeting and were supplied written material, including Canada's Food Guide to Healthy Eating and Canada's Physical Activity Guide to Healthy Active Living, which are summary plans for healthy living (Anand et al., 2007).

The primary results of the intervention were changes from baseline in daily energy intake, and changes in physical activity. Secondary results included changes in knowledge and attitudes toward healthy lifestyles, self/response efficacy, body fat, BMI, abdominal fat, blood pressure, glucose, and lipids from baseline to the end of intervention (Anand et al., 2007).

The fifth intervention was a Chinese evaluation of a classroom-based physical activity promotion program. The study design was a prospective cohort study. This included elementary school children from grades 1 to 5, with a total of 328 students (150 boys and 178 girls) from the intervention school and 425 students (207 boys and 218 girls) from the control school. The study implemented an intervention that included a classroom-based physical activity program. Many protected and age- and space-appropriate personal activities were included in the program materials. The program was coordinated and applied by teachers, taking about ten minutes at the least once every school day from October 2004 to June 2005. Information on age, gender, height, weight and physical activity patterns of all subjects were collected before and after involvement. Important increases in the average daily physical activity energy expenditure and duration among the students in the intervention school were discovered after the end of the intervention. In addition, there were important dissimilarities in the change in energy expenditure and duration of physical activity between the intervention and control schools. Finally, the BMI of boys in both the intervention and control schools and girls in the control school expanded considerably after the intervention (Liu et al., 2008).

The sixth intervention was an evaluation of a pilot hospital based community education program implementing fitness and nutrition education for overweight children in Leesburg, Virginia. Study participants were a convenience sample comprising of community members who responded to study advertisements to participate in the Kids Living Fit (KLF) program offered at the hospital. There were a total of 185 self-selected participants in the two study groups, KLF intervention group (n= 80) and the no intervention/contrast group (n=105), all of whom were in the second to fifth grades at one of four local elementary schools. The study implemented an intervention that included weekly exercise programs, monthly nutrition education, study questionnaires and daily diaries. The intervention lasted for 24 weeks. At the end, the overall mean BMI decreased between baseline and week 12 (-0.4) and week 24 (-0.6). In addition, the overall mean waist circumference (inches) decreased as well between baseline and week 12 (-0.5) and week 24 (-0.7). Finally, the advantage of a hospital-based program may be the proficiency to target overweight populations that otherwise might not take part in an after-school program for worry of being recognized as overweight by their classmates (Speroni et al., 2008).

The seventh intervention was a Physical Activity and Healthy Eating in the After-School Environment with 9-13-year-olds in Lawrence, Kansas. This study is the first to systematically describe moderate and vigorous physical activities (MVPA) and health education during the after-school environment, independent of outside intervention. Findings from these seven after-school sites indicated that children were spending approximately 47 minutes of after-school time in active recreation, with 49% of this time in organized activities and 51% in free play. The study found that children in an after-school setting were spending significantly more time in MVPA while in free play than when in organized activities (Coleman et al., 2008).

The eighth intervention was an Australian intervention called Switch-Play, which was implemented among fifth-grade students between 10 and 11 years of age. The intervention was based on several theories, social cognitive theory (such as, self-efficacy and behavioral capability) and behavioral choice theory (such as, preference and reinforcement), using techniques for example self-monitoring, behavioral contracting to "switch off" the TV, reinforcement and skill-building. Behavioral modification (BM) condition and an improve children's fundamental movement skills (FMS) condition were two intervention components that been used. These intervention components were delivered in addition to the usual physical education and sports classes. Each of the intervention conditions consisted of 19 lessons (40-50 minutes each), which were delivered by a qualified physical education teacher from March to November 2002 -one school year in Australia (Salmon et al., 2008).

There was a significant intervention outcome between baseline and post intervention on children's

BMI among those in the combined BM/FMS group compared with the control group. Also, there were significant intervention effects between baseline and post intervention for children's TV viewing among children in the BM group compared with those in the control group. Moreover, there were significant average differences in physical activity enjoyment between baseline and post intervention, with children in the FMS group reporting higher average enjoyment scores over time compared with those in the control group. However, there were no significant intervention outcomes on FMS z-scores between baseline and post intervention. Finally, from baseline to post intervention, there were no specific conclusion or outcomes of the intervention such as children's satisfy with their body shape and body weight, or eating to gain weight or lose weight in the last month (Salmon et al., 2008).

The ninth intervention is a Policy-Based School Intervention to Prevent Overweight and Obesity, which has multiple components such as school self-assessment, nutrition education, nutrition policy, social marketing, and parent outreach. Participants were 1,349 students in grades 4 through 6 from ten schools in the Mid-Atlantic region of the USA. Heights and weights were measured annually on a digital scale and wall-mounted stadiometer by a trained research team with a standardized protocol. Dietary intake, specifically total energy consumed (kilojoules), fat consumption (grams), and the number of fruit and vegetable servings, was measured with the Youth/Adolescent Questionnaire, a self-administered 152-item food frequency questionnaire has been used to measure dietary intake. Measurements were collected twice at baseline in the spring semester and again at year two in the spring semester. The study demonstrated that a multi-component school-based intervention can be useful in preventing the overweight among children in grades 4 through 6 in urban public schools (Foster et al., 2008).

The tenth intervention was an Evaluation of the USDA Fresh Fruit and Vegetable Program in schools in Wisconsin. Students in the 4th, 7th, and 9th grade across 25 intervention schools and 10 matched control schools in Wisconsin participated in this study. It was a non-randomized controlled trial study. This intervention aimed to evaluate whether the Wisconsin Fresh Fruit and Vegetable Program (FFVP) is an effective method of introducing school-age children to fresh fruits and vegetables as a healthy food choice. Specifically, the study sought to determine whether the program resulted in positive changes in attitudes and behaviors related to fruit and vegetable consumption. Overall, findings indicate that students were more willing to eat fruits than vegetables and also more willing to try both fruits than vegetables at home versus at school (Jamelske et al., 2008).

The eleventh intervention was performed by James and colleagues in the United Kingdom and included two years of follow-up on the Christchurch obesity prevention program in schools (CHOPPS). This project was started in August 2001 and was completed over one school year. It was based in six

junior schools in southern England and included children aged 7-11. The intervention focused on discouraging children from consuming carbonated drinks and involved one hour of additional health education during each of the four school terms. Results showed that no significant difference in the baseline z-scores between children in the control and intervention groups at the final measurement (James et al., 2007).

The twelfth intervention is Project Energize, from New Zealand, which aimed to increase children's activity levels, reduce sedentary time, and optimize nutritional intake through changes in the school environment and culture. There were sixty-two primary schools with sixty-two control schools participating in this study. The benefits of the intervention include improved body composition, improved dental health, and improvements in a range of associated health measures. The project's evaluation provided evidence in the school setting of what is effective, practical and affordable. At the same time determining what was unproductive, unfeasible or uneconomic, thus helping direct public money and effort into best practices (Graham et al., 2008).

The thirteenth intervention was a Canadian intervention called Healthy Buddies which consisted of three main components of healthy living: being physically active, eating healthy foods, and having a healthy body image. The intervention consisted of twenty-one healthy-living lessons which been planned and educated over the course of the study school year. Students in 4th through 7th grade were matching with kindergarten through 3rd grade buddies. In addition, students in 4th through 7th grade at the intervention school weekly received a 45-minute healthy-living lesson from the intervention teacher. The students gave the opportunity to act as peer educators by teaching a 30-minute lesson to their kindergarten through 3rd grade buddies. Buddy lessons were being provided by range of techniques (e.g., presentations, games, art activities, etc). At the results, this pilot study recommended that peer-led teaching can be a successful instrument to increase health knowledge, health behaviors, and health attitudes in children in elementary school. In addition, combination classes and classroom teachers could increase reliability and provide sustain for the program. Having all students and teachers participated in the intervention impacted the culture of the whole school (Stock et al., 2007).

The fourteenth intervention was Be Active Eat Well from Australia. Children ages 4 through 12 were eligible to participate in the study. It was quasi-experimental with nonrandomized intervention and control groups and measures taken pre- and post-intervention in the same children. It was successful at decreasing the weight gain (about 1 kg) and waist gain (about 3 cm) in elementary school. This intervention was considered as the first obesity prevention program to show significant reductions in the social gradient in weight gain, and as a result this approach may be very important for reducing obesity-related health disparities in children (Sanigorski et al., 2008).

The fifteenth intervention was the YMCA Program for Childhood Obesity a retrospective cohort study implemented in 2007 in the general pediatric clinic at UTMB at Galveston, Texas. At clinic appointments and Fit N Fun sessions, heights were measured. After that, data were entered into the electronic medical record. Then, sessions were arranged weekly during the evening at a local church. These sessions included behavior and stress management and healthy food preparation. In this intervention parents were involved in all sessions. The results showed that active participants (43%) had a clinically significant change in weight gain compared with controls. However, the analysis did not show any correlation between change in weight and risk factors for success or failure in Fit N Fun, such as age, ethnicity and number of evening sessions attended (McCormick et al., 2008).

The sixteenth intervention, is from West Virginia called L.I.F.E., was based on several behavioral theories such as hierarchy of needs, social cognitive theory, ecological perspective, health belief model, stages of change, and PRECEDE-PROCEED. The intervention consisted of awareness/knowledge tactics, school newsletter articles, a poster contest, pedometers for teachers, teacher training for e-learning unit *Healthy Hearts 4 Kids*, incentive-based programs, school-based walking programs, family-based walking/physical activity programs, No-TV Week, parent-child cooking classes, parent-child exercise classes and adult smoking cessation classes (Northrup et al., 2008).

As part of the programs philosophy the school, as the educational institution of the community is a place to learn and an avenue of outreach to parents. School nurses were chosen to offer intervention components because they are centrally situated to address both the health risks connected with obesity and the health promotion behaviors that may prevent the situation. During L.I.F.E., the school was shown to be part of the solution, addressing the health risks connected with childhood obesity (Northrup et al., 2008).

The seventeenth intervention is the Louisiana (LA) health childhood obesity prevention program, which took place in rural schools. Based on social learning theory, the intervention lasted three years and included elements of primary and secondary prevention. This randomized controlled trial consisted of healthy diet promotion, physical activity promotion, a program for families, a classroom curriculum, and Internet counseling and education. The main result of the intervention was policy decisions made by a five-person committee that includes scientists and community and state education leaders (Williamson et al., 2008).

The eighteenth intervention was performed by Jyu-Lin Chen and colleagues in the USA and aimed to test the feasibility and impact of an individually tailored educational intervention to promote healthy weight in Chinese-American children ages 8–10. The intervention was based on the ecological model of childhood obesity prevention, and was focused on the

improvement of Chinese American children's obesity-related health behaviors (such as physical activity and food preference), their knowledge, and their BMI over six months. Components were delivered through postal mail, and at the intervention's end mothers' knowledge regarding their children's dietary and activity needs was examined. The results demonstrated that an individually tailored program via mail helps reduce BMI scores in overweight children and improve children's levels of physical activity, usual food choices, and knowledge of nutrition and physical activity (Chen et al., 2008).

The nineteenth intervention was the APPLE project from New Zealand. A total of 384 children and their families participated in this intervention study. APPLE was a multifaceted intervention that consisted of increasing the levels of physical activity, increasing the intake of fruit and vegetables, and reducing the intake of sugary drinks by providing cooled water filters in each school. The intervention lasted two years and resulted in significant changes to mean BMI z-scores among intervention children, which were 0.09 less than in control children after one year and 0.26 at two years. Waist circumference was also significantly lower at two years in intervention children (1.0 cm), and systolic blood pressure was lower at one year, although this was no longer significant at two years. Although the prevalence of overweight was lower in intervention children, differences were not significant once adjusted for baseline values (Taylor et al., 2006).

The twentieth intervention was a two-year follow-up of the APPLE project. In this follow up, efforts were made to re-contact all children living within a 200-km the original study site via existing study addresses, the electoral roll, telephone directories, and information from participating schools. All children with at least one measurement of height and weight in the first study were qualified to participate in the follow-up measurements. The follow-up of the APPLE study, showed the continuing benefit of a relatively low-cost program aimed at reducing the risk of excessive weight gain in children almost two years after the conclusion of an official intervention phase during the follow-up period. The follow-up results showed the initial decrease in adjusted BMI z-score (0.22-0.30 units) in the intervention children relative to the control children. Nineteen percent significantly reduction in the prevalence of overweight has been showed in children who were present for the full two years of intervention (Taylor et al., 2008).

The twenty-first intervention targeted Latino mothers and children in grades 2 through 11. The Families on the Move (FOTM) lasted for eight weeks, and included distribution of workbooks, pedometer demonstration and distribution to parents and children, weekly reading assignments, goal setting, and evaluation. The intervention found that majority of the mothers (84.6%) approved the idea that they can influence their child's food choices. The mothers also believed they were able to influence physical activity levels (92.3%) for their children. This intervention lasted for 8-week program and was shown to be

achievable but it is too early to say whether will be significant (James et al., 2008).

The final intervention was the Walking the Talk effort aimed to improve staff self-efficacy in counseling Women, Infants, and Children (WIC) clients about childhood overweight. The California Fit WIC developed this multilevel intervention to prevent pediatric overweight and the effect included staff training sessions on a variety of topics, the addition of new classes for WIC clients, and the organization of community-wide coalitions to address the issue. The intervention lasted for a year and showed that support from the Fit WIC team helped staff achieve their own healthy eating and physical activity goals and significantly increased staff obligation and enthusiasm for addressing healthful behavior patterns with clients (Northrup et al., 2008).

DISCUSSION

The purpose of this study was to identify theoretical frameworks that drive childhood obesity prevention programs and identify successful components of childhood preventive intervention programs. Based on a review of these interventions, it is evident that there is a need for more primary prevention programs, 22 interventions from around the world were found to tackle the critically important issue of childhood obesity. Of the 22 interventions, thirteen were performed in United State of America, two in Canada, three in New Zealand, one in China, two in Australia and one in England (Untied Kingdom).

The majority of the interventions (n=13) were developed and implemented in elementary schools. Two interventions were implemented in elementary, middle and high schools, and four were carried out at all levels, from preschool to high school. In addition, one intervention was conducted in workplace.

Most of these interventions (n =18) targeted health behaviors aiming to increase physical activity, decrease BMI, and improve nutrition behaviors. However, there were some interventions that focused on only one element, such as increasing physical activity time in the school or community or creating nutrition plans and policies in schools. Efforts were also made by (n=12) programs to reduce TV viewing time for children and their families.

Although comprehensive programs are valuable, single-component programs demonstrated significant results. Examples include the classroom-based physical activity promoting program targeting physical activity behaviors and the Fresh Fruit and Vegetable Program intervention targeting nutritional behaviors (Stock et al., 2007). However, there is no evidence showed that single component interventions are better than comprehensive interventions. Consequently, it is necessary to consider both comprehensive and single-component intervention programs. In terms of theory, a small number of interventions (n = 6) were based on behavioral theory, but the majority of the published interventions were not based on behavioral theories. The six interventions that did apply a behavioral theory used the social ecological model, the protection motivation theory,

social learning theory, normative influences and theories of persuasion, social cognitive theory, behavioral choice theory, hierarchy of needs, ecological perspective, health belief model, PRECEDE-PROCEED, and the ecological model-ecological system theory (EST). In addition, one of the six interventions used role models and self-esteem as a component in the program. Some of these six interventions utilized more than one theory, despite the fact that it is beneficial to apply only one theory in order to test the effectiveness of an intervention and see which components or constructs of the theory are most effective. From the 22 published studies, only nine were able to show significant outcomes, while 13 were not able to show any impact. Seven of the non-theoretical based interventions showed significant result, while only two of the project based on specific behavioral theories.

The majority of the interventions (n = 5) were one academic year in duration. Four were short lasted only eight weeks, three were 32 weeks in length, one was 12 weeks long, four were 24 weeks, two lasted 36 weeks, and three lasted two full years. This finding emphasizes the need to design behaviorally healthy interventions for the diverse target populations and also measure significant outcomes. As a whole, no conclusions can be drawn regarding the impact duration of the intervention on effectiveness. For example, among the three longest interventions, two were effective while the other one was not. Similarly, for the five interventions that were one academic year long, four showed significant changes in diet, physical activity and BMI, while one did not.

Six interventions relied on the participation of parents in helping with behavior change. All had significant positive outcomes related to diet, physical activity and BMI. This is an important finding, and one that emphasizes the role of parental participation in school interventions. Parents play vital and important role in the lives of their children, including their influence on dietary and physical activity behaviors (James *et al.*, 2008). Childhood obesity prevention programs could have more significant outcomes by involving parents in developing healthy behaviors for them and their children (Northrup et al., 2008).

Among the 22 published studies, ten interventions focused on individual level behavior change and twelve included some nutrition policy changes. With respect to individual behavior, components included cooking classes for families, training on food selection, and health education session on disordered eating.

In terms of the methodology, five studies used pre-experimental designs, ten studies used quasi experimental designs, six studies used experimental designs and only one study used both on experimental and quasi experimental design. Many studies (n=7) focused on measuring long-term changes at least one year after the baseline which is beneficial because often take interventions a long time to show effects. The majority of the intervention studies (n=21) included baseline assessments and post assessments as

well. Finally, four studies are ongoing and more outcome data are expected from these studies.

In terms of measurement of behaviors, the majority of the studies (n=22) measured changes in factors (such as times spent being physically active, fruit/vegetable intake, and reductions in TV viewing). Many of these studies were able to show positive outcome towards progress of healthy behaviors. However, some of the studies only assessed the knowledge among participants, rather than looking at changes in behavior, which is not ideal. There is a need to create better scales to evaluate behavior change, particularly for studies that are based on specific behavioral theories.

From the 22 published studies, six interventions relied on secondary prevention while fifteen interventions used a primary prevention method. Only one intervention used both types.

LIMITATIONS

There are a number of limitations to this study. First, some studies (n=14) focused on childhood obesity in general and were excluded as a result. Second, some interventions were published in other languages such as German and Italian, and were not able to be reviewed. Third, only interventions published in two databases (PubMed and Google Scholar) were included. While these databases are reasonably broad, they do not include all the health literature about childhood obesity prevention around the world. As a result of these interventions, a conclusive meta-analysis cannot be achieved with these studies and explanations cannot be made concerning the effect size of the interventions.

RECOMMENDATIONS

Schools are the best settings for childhood obesity interventions because children form lifelong eating and physical activity habits at a young age. School-based interventions focused on childhood obesity prevention must target enhancement of physical activity and healthy nutrition in order to decrease BMI. In changing physical activity behaviors, increasing the duration and types of different activities are important aspects. Increasing fruit and vegetable intake and reducing the intake of sweetened drinks is of critical importance in changing nutrition behaviors. As these studies demonstrate, parental participation plays an important role in school-based interventions. It is essential to involve parents in all school-based interventions for childhood obesity prevention. While many of the studies included in this review were not based on theory all intervention should utilize behavioral theories. Interventions should also include both baseline assessments and post-intervention assessments to make it easy to evaluate the impact of the intervention. As part of this there is a need to create a valid scale that can identify and measure changes in the constructs of any behavioral theories used. Schoolteachers are very useful for implementing the interventions because though their teaching they can encourage the students to eat healthy and be active. In addition, different health professionals such

as nurses and social workers are very important resources for implementing school-based interventions. Finally, interventions should seek to incorporate individual behavior change strategies with policy and environmental changes in order to make a substantial and sustainable impact on children's health and well-being.

Acknowledgements: The authors express their gratitude to Dr. Darlene Sheare and Dr. Cecilia Watkins for their invaluable assistance, support and guidance; without whose knowledge and assistance this study would not have been possible.

REFERENCES

- Anand, S.S., Davis, A.D., Ahmed, R., Jacobs, R., Xie, C., Hill, A., *et al.* (2007). A family-based intervention to promote healthy lifestyles in an aboriginal community in Canada. *Canadian Journal of Public Health*, 98(6):447-52.
- Center of Disease Control and Prevention. (2004). *Trends in child and adolescent overweight*. Retrieved from: http://www.cdc.gov/nchs/products/pubs/pubd/hestats/overweight/overwght_child_03.htm
- Center of Disease Control and Prevention. (2010). *Childhood overweight and obesity*. Retrieved from: <http://www.cdc.gov/obesity/childhood/index.html>
- Chen, J. L., Weiss, S., Heyman, M. B., Vittinghoff, E., & Lustig, R. (2008). Pilot study of an individually tailored educational program by mail to promote healthy weight in Chinese American children. *Journal for Specialists in Pediatric Nursing*, 13(3):212-221.
- Coleman, K., Geller, K., Rosenkranz, R., & Dziewaltowski, D. (2008). Physical Activity and Healthy Eating in the After-School Environment. *Journal of School Health*, 78(12): 633-640.
- Dehghan, M., Danesh, N., and Merchant, A. (2005). Childhood obesity, prevalence and prevention. *Nutrition Journal*, 4:24.
- Eisenmann, J.C., Gentile, D.A., Welk, G.J., Callahan, R., Strickland, S., & Walsh, M. (2008). SWITCH: rationale, design, and implementation of a community, school, and family-based intervention to modify behaviors related to childhood obesity. *BMC Public Health*, 8:223.
- Flodmark, C., Lissau, I., & Pietrobelli, A. (2005). Child and adolescent obesity: Why we need to fight!. *Acta Paediatrica*, 94: 4-7.
- Flynn, M., McNeil, D., Tough, S., Maloff, B., Ford, C., Mutasingwa, D., & Wu, M. (2004) Reducing Obesity and Related Chronic Disease Risk in Children and Youth: A Synthesis of Evidence with 'Best Practice' Recommendations. *The International Association for the Study of Obesity; Obesity Reviews*, 7(1): 7-66.
- Foster, G.D., Sherman, S., Borradaile, K.E., Grundy, K.M., Vander Veur, S.S., Nachmani, J., *et al.* (2008). A Policy-Based School Intervention to Prevent Overweight and Obesity. *American Academy of Pediatrics*, 121:e794-e802.

- Graham, D., Appleton, S., Rush, E., McLennan, S., Reed, P., & Simmons, D. (2008). Increasing activity and improving nutrition through a schools-based programme: Project Energize. Design, programme, randomisation and evaluation methodology. *Public Health Nutrition*, 11(10): 1076–1084.
- Gualdi-Russo, E., Albertini, A., Argani, L., Celenza, F., Nicolucci, M., & Toselli, S. (2008). Weight status and body image perception in Italian children. *Journal of Human Nutrition & Dietetics*, 21(1):39–45.
- Hodges, E. (2003, January). A Primer on Early Childhood Obesity and Parental Influence. *Pediatric Nursing*, 29(1):13.
- James, J., Thomas, P., and Kerr, D. (2007). Preventing childhood obesity: two year follow-up results from the Christchurch obesity prevention programme in schools (CHOPPS). *British Medical Journal (BMJ)*, 335: 762.
- James, K., Connelly, C., Rutkowski, E., McPherson, D., Gracia, L., Mareno, N., et al. (2008). Family-Based Weight Management with Latino Mothers and Children. *Journal for Specialists in Pediatric Nursing*, 13(4): 249-262.
- Jamelske, E., Bica, L.A., McCarty, D.J., Meinen, A., (2008). Preliminary Findings from an Evaluation of the USDA Fresh Fruit and Vegetable Program in Wisconsin Schools. *Wisconsin Medical Journal*, 107(5):225-230.
- Joose, L., Stearns, M., Anderson, H., Hartlaub, P., & Euclide, J. (2008, Aug). Fit Kids/Fit Families: a report on a countywide effort to promote healthy behaviors. *Wisconsin Medical Journal*, 107(5):231-6.
- Jordan, K., Erickson, E., Cox, R., Carlson, E., Heap, E., Friedrichs, M., et al. (2008). Evaluation of the Gold Medal Schools Program. *Journal of the American Dietetic Association*, 108(11):1916-1920. Retrieved June 15, 2009.
- Liu, A., Hu, X., Ma, G., Cui, Z., Pan, Y., Chang, S., et al. (2008). Evaluation of a classroom-based physical activity promoting programme. *Obesity Reviews*, 9: 130-134.
- McCormick, D., Ramirez, M., Caldwell, S., Ripley, A., & Wilkey, D. (2008). YMCA Program for Childhood Obesity: A Case Series. *Clinical Pediatrics*, 47(7): 693-697.
- Muller, M., Dnielzik, S., & Pust, S. (2005). School and family-based interventions to prevent overweight in children. *Proceedings of the Nutrition Society*, 64: 249–254.
- Northrup, K. L., Cottrell, L. A., & Wittberg, R. A. (2008). L.I.F.E.: A School-Based Heart-Health Screening and Intervention Program. *The Journal of School Nursing*, 24(1), 28-35.
- Olshansky, S., Passaro, D., Hershov, R., Layden, J., Carnes, B., Brody, J., et al. (2005, March 17). A Potential Decline in Life Expectancy in the United States in the 21st Century. *New England Journal of Medicine*, 352(11):1138-1145.
- Sharma, M. (2007). International school-based interventions for preventing obesity in children. *Obesity Reviews*, 8(2):155-167.
- Salmon, J., Ball, K., Hume, C., Booth, M., & Crawford, D. (2008). Outcomes of a group-randomized trial to prevent excess weight gain, reduce screen behaviours and promote physical activity in 10-year-old children: Switch-Play. *International Journal of Obesity*, 32(4): 601-612.
- Sanigorski, A., Bell, A., Kremer, P., Cuttler, R., & Swinburn, B. (2008). Reducing unhealthy weight gain in children through community capacity-building: results of a quasi-experimental intervention program, Be Active Eat Well. *International Journal of Obesity*, 32(7): 1060-1067.
- Speroni, K., Tea, C., Earley, C., Niehoff, V., & Atherton, M. (2008). Evaluation of a Pilot Hospital-Based Community Program Implementing Fitness and Nutrition Education for Overweight Children. *Journal for Specialists in Pediatric Nursing*, 13(3):144-153.
- Stock, S., Miranda, C., Evans, S., et al (2007). Healthy Buddies: A Novel, Peer-Led Health Promotion Program for the Prevention of Obesity and Eating Disorders in Children in Elementary School. *American Academy of Pediatrics*, 120: e1059-e1068.
- Taylor, R. W. , McAuley, K. A., Barbezat, W., Farmer, V. L., Williams, S. M., & Mann, J. I. (2008). Two-year follow-up of an obesity prevention initiative in children: the apple project. *The American Journal of Clinical Nutrition*, 88: 1371-1377.
- Taylor, R. W. , McAuley, K. M. , Williams, S. M., Barbezat, W., Nielsen, G., & Mann, J. I. (2006). Reducing weight gain in children through enhancing physical activity and nutrition: the apple project. *International Journal of Pediatric Obesity*, 1(3): 146-152.
- Whitaker, R., Wright, J., Pepe, M., Seidel, K., & Dietz, W. (1997). Predicting Obesity in Young Adulthood from Childhood and Parental Obesity. *New England Journal of Medicine*, 337(13): 869-873.
- Williamson, D. A., Champagne, C. M., Harsha, D., Han, H., Martin, C., Newton, R., & et al. (2008). Louisiana (LA) health: design and methods for childhood obesity prevention program in rural schools. *Contemporary Clinical Trials*, 29(5): 783-795.

9/22/2011

A case of hermaphroditism that presented as a pelvic cystic mass

Da Zhang¹, Jiaxiang Wang¹, Yingzhong Fan¹, Weihong Zhang^{2*}

¹Department of Pediatric Surgery, the First Affiliated Hospital of Zhengzhou University, Zhengzhou 450052, China

²The Nursing College of Zhengzhou University, Zhengzhou 450052, China

Abstract This report presents the case of a 14-year-old individual who was raised as a male child. The patient had a history of bilateral cryptorchidism combined with hypospadias, he visited our hospital with complaints of urinary retention and a cystic mass behind the bladder after the operation of urethroplasty for hypospadias. Pathological tests of the cystic mass showed that it was uterine tissue, but no ovarian tissue was found. The clinical diagnosis of mixed gonadal dysgenesis was confirmed in the case.

[Da Zhang, Jiaxiang Wang, Yingzhong Fan, Weihong Zhang. **A case of hermaphroditism that presented as a pelvic cystic mass.** Life Science Journal. 2011;8(4):61-63] (ISSN: 1097-8135). <http://www.lifesciencesite.com>.

Key words: hermaphroditism ; misdiagnosis; mixed gonadal dysgenesis

Case report

The patient was a 14-year-old boy who had undergone urethroplasty and bladder fistulization for second-degree hypospadias at another hospital 2 months before being admitted to our hospital. He had a weak urine stream after the operation and experienced dysuria for 2 days before admission to our hospital. Moreover, 20 days after the surgery, leakage of urine was found near the ventral root of penis, and the urine was seen as a thin stream. No special treatment was provided; however, 7 days before he was admitted to our hospital, urethral dilatation was performed at another hospital. Two days earlier, dysuria had aggravated with dribbling and cloudy urine accompanied by frequent urination, urgent urination, odynuria, and tolerable intermittent lower abdominal pain. The results of the physical examination showed that his height was 154 cm, and he showed normal male sex characteristics such as a developed Adam's apple, normal beard, and pubic hair distribution. The lower abdominal area around the bladder was bulging. The penis and the scrotum were normally developed. The penile appearance was similar to that after urethroplasty and an urethral orifice was located at the glans. In the normal state, the length of the penis was 6 cm, and a fistula with a diameter of 1 mm was found near the ventral root of the penis. The patient had difficulty in urination; the proximal urethra at the urethral anastomotic site expanded significantly during urination, and the urine stream was thin. The size and texture of the left testis were normal. The left epididymis was about 1.5 cm × 1 cm × 1 cm, was hard on touch, and showed tenderness, while the right scrotum was empty. The testicle was not palpable in the right scrotum and inguinal region. A digital rectal examination showed the presence of an elongated, palpable cystic mass in front of the rectum, with a left-right diameter of 4.5 cm. The upper boundary could not be touched, and the

surface was smooth without obvious tenderness. The patient's medical history included surgery for bilateral cryptorchidism at a local hospital when he was 3 years old. Orchidopexy of only the left testis was performed by surgery, and biopsy of the sex gland confirmed that it had testicular tissue, while the right testis was not checked. The patient had undergone urethroplasty 2 months before being admitted to our hospital for hypospadias.

Additional examinations

Retrograde urography (Figure 1): Retrograde urography with an indwelling catheter was performed through the urethral orifice. About 300 ml of slightly cloudy yellow urine was drained, and the contrast agent was injected through the catheter. The angiographs showed that the catheter was indwelled into a strip-like cyst cavity whose length was 14.5 cm and diameter was 5 cm. The cyst cavity was seen as an abnormality of the bladder. After the catheter removal and urination, the volume of the cyst was not significantly reduced.

Computed tomography (CT) (Figure 2): Although abnormalities in the bladder size and shape were not evident in the CT scans, a cystic mass with a diameter of about 5 cm was found behind the bladder. This mass had a clear border, and a smooth cystic wall and shared its boundary with the bladder and the rectum. The CT value of the cystic fluid was close to that of urine in the bladder.

Urinary system ultrasonography: The ultrasonography of the urinary system showed normal size and morphology for both the kidneys. The renal capsule was smooth, and solid echo was uniform. The upper poles of both the kidneys were normally placed, while the lower poles drew closer to the spine and assembled as low-echo regions in front of the spine. Bladder filling was good and the continuity of the bladder wall was complete. An irregular cystic echo of

115 mm × 52 mm × 31 mm with a clear boundary was found at the right rear side of the bladder. After urination, the pattern of the cystic echo did not change.



Figure 1. The angiographs showed that the catheter was indwelled into a strip-like cyst cavity but the urinary bladder did not develop.

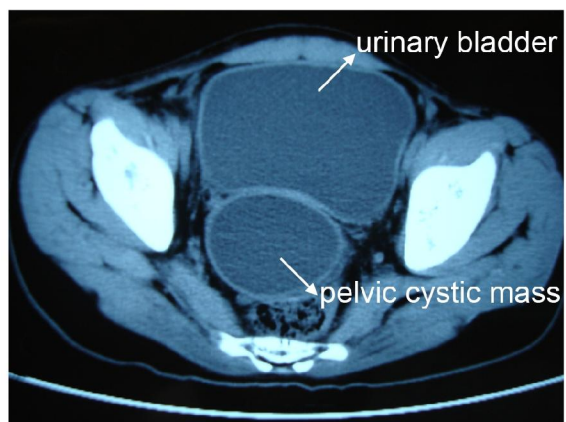

Figure 2. A cystic mass behind the urinary bladder was showed in CT.

Treatment course: After anti-infection treatment, surgical treatment was performed. A long fusiform cystic mass similar to the uterus was found behind the bladder during surgery. A clear, pale yellow liquid was extracted from the puncture. Running downward

along the rectovesical pouch and ending below the neck of the bladder, the uterine broad ligament-like tissue had blood vessels running within it and was found to connect with the lateral peritoneum on the right side. A gonadal tissue (1.5 cm × 1.0 cm) similar to that of the ovary was found in the right iliac fossa. Both the ureters and the bladder were normal. A cystic mass was isolated from the place where the lower part of neck of the bladder meets the posterior urethra, and then the mass was removed. The gland similar to the ovary was removed by surgery, and the urinary fistula was repaired.

Pathological findings: The tested tissues were uterine and oviduct tissue, and no ovarian tissue was found.

Chromosomal examination: The karyotype was 45X/46XY, sex-determining region of Y chromosome (SRY) (+).

Reviewed CT scans: No obvious abnormalities in the bladder size and shape were seen. The cystic mass behind the bladder disappeared.

Discussion

The patient in this case was raised as a male child and had normal scrotal development but showed hypospadias at birth. When he was first admitted to the hospital, he underwent surgical treatment for bilateral cryptorchidism for the left testis, which was confirmed by histological examination. However, the cryptorchidism in the right testis was not identified. On the second admission, he was diagnosed with cryptorchidism combined with hypospadias, while hermaphroditism was not considered. The chromosome karyotype was not examined, and simple urethroplasty was performed without checking the right sex gland. For the 2 times that the patient was admitted to the hospital, the diagnosis of hermaphroditism was missed. This shows that some medical units still lack an understanding for diagnosing hermaphroditism. Therefore, we should be vigilant in cases of children with bilateral cryptorchidism, hypospadias, and chromosome karyotype analysis, SRY inspection, sex hormone examination, and imaging tests should be performed in early childhood to identify the chromosome sex.

Postoperative pathology confirmed the presence of effusion from the uterus that was present behind the long strip-like cystic mass situated behind the bladder. The effusion may be caused by the following reasons: urethral stenosis occurred after urethroplasty; therefore, the patient had dysuria and urinary retention. Since the uterus was connected to the posterior urethra by remnants of the degraded Mullerian tube [1, 2], effusion was easily caused during uroschesis. Since the detrusor muscle rather than the uterine smooth muscle contracted during urination, the volume of the

cystic mass behind the bladder did not reduce after urination. Conditions such as mixed gonadal dysgenesis, incomplete degradation of the Mullerian system, and the presence of an additional uterus, vagina, or 1 fallopian tube can present as masculine insufficiency [3]. For this patient, the nature of the cystic mass behind the bladder was unknown at the time of previous operations. Uterine effusion was considered according to the medical history and chromosome karyotype. This case is clinically significant because it suggests that in the case of urethral stricture and urinary retention, the cystic mass behind the bladder may be the uterus with effusion in patients with hermaphroditism

A case of hermaphroditism with a chromosome karyotype of 45X/46XY can present as mixed gonadal dysgenesis or true hermaphroditism. In this case, pathological testing of the strip-shaped right gonadal tissue did not show presence of ovarian tissue, suggesting mixed gonadal dysgenesis. The strip-shaped gland was removed by using surgery for its malignant tendency [4, 5].

9/26/2011

***Corresponding author:** Weihong Zhang
School of Nursing, Zhengzhou University, Zhengzhou, China
E-mail: zhweihong@126.com

References

1. Vidal I, Gorduza DB, Haraux E, Gay CL, Chatelain P, Nicolino M et al. Surgical options in disorders of sex development (dsd) with ambiguous genitalia. *Best Pract Res Clin Endocrinol Metab* 2010 24: 311-24.
2. Breech LL, Laufer MR. Mullerian anomalies. *Obstet Gynecol Clin North Am* 2009; 36: 47-68.
3. Bidarkar SS, Hutson JM. Evaluation and management of the abnormal gonad. *Semin Pediatr Surg* 2005; 14: 118-23.
4. Looijenga LH, Hersmus R, de Leeuw BH, Stoop H, Cools M, Oosterhuis JW et al. Gonadal tumours and DSD. *Best Pract Res Clin Endocrinol Metab* 2010 24: 291-310.
5. Uehara S, Hashiyada M, Sato K, Nata M, Funato T, Okamura K. Complete XY gonadal dysgenesis and aspects of the SRY genotype and gonadal tumor formation. *J Hum Genet* 2002; 47: 279-84.

Preliminary Study on Solid-phase Hybridization for Detection of Common Pathogenic Bacteria Causing Fungal Keratitis

Zhang Yinglang, Wang Liya, Li Zhitao, Sun Shengtao

Henan Eye Institute, Zhengzhou, 450003. zhanglyks@126.com

Abstract: Objective: To develop an experimental method for the rapid detection and accurate identification of common pathogenic bacteria causing fungal keratitis in China based on the gene chip principle and by the solid-phase hybridization technology. **Methods:** For the 6 categories and 12 species of common clinical fungi causing keratitis in China including *Fusarium solani*, *Fusarium moniliforme*, *Fusarium poae*, *Fusarium oxysporum*, *Aspergillus fumigatus*, *Aspergillus flavus*, *Aspergillus terreus*, *Aspergillus niger*, *Curvularia lunata*, *Penicillium implicatum*, *Alternaria alternate*, and *Candida albicans*, fixed a specific oligonucleotide probe onto an aldehyde slide. Amplified the above fungi with a pair of fluorescence labeling universal primers, hybridized the fluorescence labeling amplified product with the probe arrayed in the slide and observed the color under a fluorescence microscope. **Result:** Through observation of agarose gel electrophoresis, 12 species of fungi all produced about 530-630 base pair PCR amplification products; conducted hybridization detection of them under the same conditions and obtained post-hybridization fluorescent color maps with their own respective characteristics; different bacteria can be directly differentiated and judged through fluorescence signals. **Conclusion:** The 12 common clinical species of pathogenic bacteria causing fungal keratitis in our country can be detected within 3-4 hours with fluorescence labeling universal primers and through PCR amplification to produce fluorescence labeling amplified products and hybridize with the oligonucleotide probe on the aldehyde slide.

[Zhang Yinglang, Wang Liya, Li Zhitao, Sun Shengtao. **Preliminary Study on Solid-phase Hybridization for Detection of Common Pathogenic Bacteria Causing Fungal Keratitis.** Life Science Journal. 2011;8(4):64-67] (ISSN: 1097-8135). <http://www.lifesciencesite.com>.

Key Words: Solid-phase hybridization, Fungal keratitis, Pathogenic bacteria, Bacteria detection

Introduction

Fungal Keratitis is a serious cause of blindness. It is an important prerequisite to rapidly, sensitively and efficiently detect the pathogenic bacteria for prevention and cure of this disease and effective reduction of the blindness rate. We attempt to rapidly detect the common pathogenic bacteria causing fungal keratitis with solid-phase hybridization technology.

1. Materials and Methods

1.1 Materials (1) Standard strains *Fusarium solani* (3.1792), *Fusarium moniliforme* (3.752), *Fusarium poae* (3.4601), *Fusarium oxysporum* (3.4743), *Aspergillus fumigatus* (3.722), *Aspergillus flavus* (3.2758), *Aspergillus niger* (3.759), *Aspergillus terreus* (3.3935), *Penicillium implicatum* (3.512), *Curvularia lunata* (3.1471), *Alternaria alternate* (3.577) and *Candida albicans* (2.538) were all bought from China General Microbiological Culture Collection Center, Institute of Microbiology, Chinese Academy of Sciences. (2) Main Instruments PTC-200 Gene Amplifier (US MJ Company), PCA300 Electrophoresis Apparatus (BIORAD Company), Centrifuge 5402 (Eppendorf Company), Alphaimager TM2200 Gel Imaging System (US Alpha Company) and BX51 Fluorescence Microscope (Japanese Olympus Company). (3) Main Reagents Reagents used in DNA extraction, polymerase chain reaction

and hybridization were provided by Sino-American Biotechnology Co., Ltd.; slide treatment agents, 3-aminopropyl triethoxysilane and sodium borohydride were bought from Sigma Company; glutaraldehyde was bought from Sangon Biotech (Shanghai) Co., Ltd. 1.2 Methods 1) Design of PCR primer and oligonucleotide probe. Obtained the gene sequence of 10 species of fungi from the Genbank, conducted sequence alignment for the retrieved fungal genomic DNA and obtained the base alignment chart and cluster analysis result. Looked for the primers in the conservative range with the Primers program. Analysed ITS1 and ITS2 specific variable region, conducted BLAST alignment and selection and designed the specific oligonucleotide probes for the 10 species of fungi with the Oligo software. The primers and probes were both synthesized by Sangon Biotech (Shanghai) Co., Ltd (Table 1). (2) Fungal DNA extraction Took 3ul as the reaction template with the guanidine isothiocyanate method [1]. (3) PCR amplification reaction system. The total reaction volume is 30ul, the 20× reaction buffer is 1.5μl, MgCl₂ solution is 2.0mM, dNTP mixture is 200μM, primers are 6pmol×2, Taq DNA polymerase is 2u and the template DNA is 3ul. The reaction condition is 94°C 5min and 1 cycle; 94°C45s, 55°C60s, 72°C 60s and a total of 36 cycles; 72°C5 min 1 cycle. (4)

Surface treatment of the slide carrier. Selected the domestic microscope slide as the carrier. Then cleaned it with distilled water and dried it by centrifugation after it was immersed in the chromic acid lotion overnight; Next, immersed it into 25% ammonia water overnight, cleaned it with distilled water and dried it by centrifugation; immersed it into 95% ethanol (PH 4.5) containing 3% 3-aminopropyl triethoxysilane, placed it into the shaker for 60 min, conducted ultrasonic cleaning with 95 % ethanol (pH 4.5) and distilled water and then dried it for 15 min at 110°C; at last, immersed the slide into 5% glutaraldehyd, placed it into the shaker for 60 min, conducted ultrasonic washing twice and dried at 110°C for 15 min ready for use. (5) Oligonucleotide probe points and treatment. Made up the probe solution with a final concentration of 50 μ mol/L, took 5 μ l from each probe solution, dissolved them into 5 μ l 3 \times SSC separately and spotted on the corresponding section of the slide with the point-like needle (Table 1). Placed the spotted slide overnight at room temperature and 80°C hydrated 2h. At first, cleaned the slide with 0.2% SDS and distilled water, then put it into NaHB4 blocking solution for 5 min and next cleaned it with 0.2% SDS and distilled water, ready for use after it was dry at room temperature. (6) Hybridization detection. Spotted hybridization solution A 50 μ l on the position of the slide fixed with a probe, took amplified product 15 μ l and mixed it evenly with hybridization solution C, which was fully mixed with solution A on the slide. Then, Made the solution take a water bath in the wet box for 1 h and then rinsed it with eluate I (1 \times SSC / 0.2 % SDS) for 1 min, eluate II (0.1 \times SSC / 0.2 % SDS) for 1 min and eluate III (0.1 \times SSC) for 1 min. Then, observed its color situation under the fluorescence microscope after it dried at room temperature.

2. Results

2.1 PCR amplification result. The universal primers can separately amplify PCR amplified products of standard strains from 10 species of common clinical pathogenic fungi causing keratitis and gel electrophoretogram (Figure 1).

2.2 Gene chip hybridization result Hybridized the PCR amplification products of 10 species of fungi strains separately with the slide spotted with 10 kinds of specific probes and one kind of universal probe and there appeared fluorescence in the positions that were fixed with corresponding probes. The result showed that the 10 kinds of probes all have high specificity and each kind of probes only react with its own corresponding PCR amplified products (Figure 2).

2.3 Sequencing result of amplified products After sequencing the PCR products of 10 species of

common clinical fungi strains causing keratitis, compared the sequencing result with the nucleic acid amplification sequence selected by this test. The result showed they have exactly the same sequence, which verifies the credibility of the hybridization result.

3. Discussion

Fungal Keratitis is a serious cause of blindness and its incidence is rising rapidly in our country. Rapid and accurate detection of pathogenic bacteria can provide timely guidance for the clinical diagnosis and treatment and effectively reduce the rate of blindness. Currently, the traditional laboratory diagnostic methods are mainly microscopic examination of corneal scraping and fungal culture. They require cumbersome and time-consuming technology and are not conducive to clinical treatment guidance^[2]. Gene chip is a molecular biology technology that newly emerged in the late 20th century. It fixes cDNA and the oligonucleotide probe onto the film base surface to form a micro-array. Because the specific position of the probe in the carrier's micro-array is preset, just by the judgment of the probe signal, the change of the gene expression and structure can be inferred. Its biggest advantage is its high-throughput, miniaturization and automated analysis of the genetic information^[4]. But it also has some problems. For example, the gene chip's preparation, detection and analysis require specific equipment and software which are quite expensive and mostly used in scientific experiments and research. Therefore, it has broad prospects for the gene chip technology to be used in the detection of pathogenic microorganisms according to our national situation. We designed the universal primer and specific probe by use of the fungal ribosomal RNA genes and conducted rapid detection of the common domestic clinical 12 species of pathogenic bacteria causing fungal keratitis in accordance with the gene chip principle, with the domestic slide as the carrier and on the basis of the epidemiological survey^[5].

By use of the computer software and in combination with artificial alignment, we found the most conservative primer and the best specific oligonucleotide probe in the fungal ribosomal RNA gene sequence^[6] which is of great significance to the fungal classification within the category and among species as well as individual differences within the category. Meanwhile, we took full account of Tm, GC content, hairpin structure and other factors, tried every means to make them reach unanimity and strove to guarantee that the probes fixed onto the same carrier can obtain the best effect under the same conditions of hybridization and fluorescence excitation, thereby ensuring the success of the detection.

In accordance with the oligonucleotide

covalently fixed principle [7,8] in the gene chip preparation, we made the aldehyde slide by ourselves and used it as the carrier to conduct solid-phase hybridization and made the amino-modified oligonucleotide probe fix on the slide by the covalent way. Amplified the standard strains of 12 species of fungi with PCR technology and further amplified the corresponding gene fragments of various fungi. On the basis of the electrophoresis detection, conducted hybridization verification on the products with the specific probe fixed onto the slide, avoiding the false positive and false negative result and overcoming the deficiency that the gel electrophoresis bands of PCR products are unable to accurately differentiate the differences within the category and among the species [9,10]. The test results show that no non-specific cross-reactivity is seen on the probe fixed onto the self-made aldehyde slide and it can conduct type testing among fungi species, showing good specificity and sensitivity in the detection of standard strains. When the concentration of the PCR products were diluted until no bands were seen in the agarose gel electrophoresis, there was still fluorescent color in the chip hybridization, indicating that the sensitivity of the chip during the detection was higher than agarose gel electrophoresis after the conventional PCR. In addition, in the hybridization reaction, we used chemical methods and made the double-stranded DNA of PCR products decompose into single-stranded one, eliminating the pre-hybridization process, reducing the processing steps and shortening the hybridization time. The credibility of the hybridization results were verified by sequencing the amplified products. Thus, we could finish the strain identification of 12 species of common domestic clinical pathogenic fungi causing keratitis within 3-4 hours through PCR amplification and the solid-phase hybridization of self-made probe carrier; moreover, we also could add other pathogenic microorganisms probes in accordance with the need of the detection and conduct type diagnosis on more keratitis pathogenic microorganisms under the multiplex PCR amplification.

In the test, we took full account of the practicality of the hybridization signal detection in the clinical work. Appropriately increased the point-like amount and point-like diameter, designed a strip of universal probe as the coordinate to read signals and additionally placed the coverslip with point-like location mark grid, which guaranteed the certainty of the probe's fixed position and the stability of hybridization. Additionally, no expensive signal reading device was needed. Only the mercury lamp was used as the fluorescence microscope to excite the light source and then the detection of hybridization signals in the corresponding point-like positions could be conducted, greatly increasing the range of clinical

applications.

This study has initially established an experimental method to detect 12 species of common domestic pathogenic bacteria causing fungal keratitis on the basis of the gene chip principle and with the solid-phase hybridization technology. This method can not only conduct rapid and convenient clinical sub-type diagnosis at low cost but also fit the large-scale epidemiological investigation. Its specificity and sensitivity will be further improved and be tested in clinical applications through the optimization and perfection of the experimental conditions.

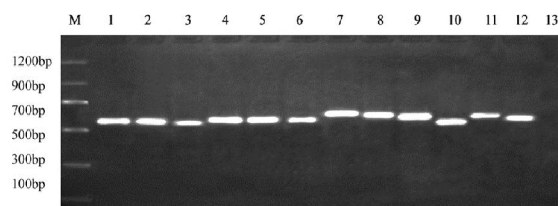

Figure 1. PCR Amplified Product Electrophoretogram

(M) DNA Molecular Weight Marker

1. *Fusarium solani*
2. *Fusarium moniliforme*
3. *Fusarium poae*
4. *Fusarium oxysporum*
5. *Aspergillus fumigatus*
6. *Aspergillus flavus*
7. *Aspergillus niger*
8. *Aspergillus terreus*
9. *Penicillium implicatum*
10. *Curvularia lunatus*
11. *Alternaria alternata*
12. *Candida albicans*
13. Negative control

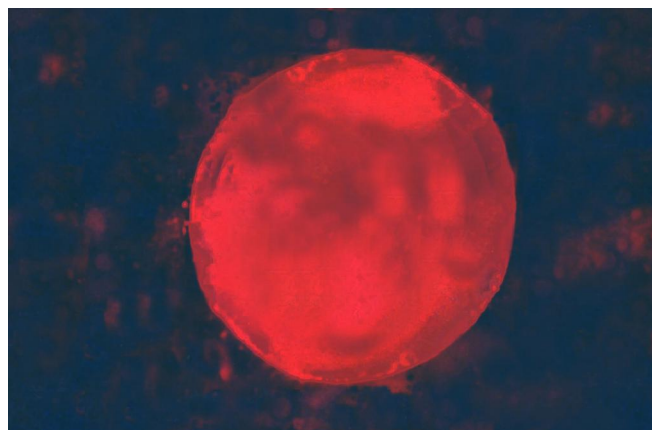

Figure 2. Positive Result of Hybridization
Fluorescence Microscope 20×

Table 1. Primer & Probe

Primer & Probe	Sequence
Universal primer	
Forward	5'--tcc gta ggt gaa cct gcg g-3'
Reverse	5'-TAMRA-tcc tcc gct tat tga tat gc-3'
Probe	
Fusarium solani	5'--aga cgg ccc tgt aac aac g ata -NH ₂ -(CH ₂) ₆ -T ₁₅ -3'
Fusarium moniliforme	5'- cg agtcaaatcg cgttccc atg -NH ₂ -(CH ₂) ₆ -T ₁₅ -3'
Fusarium poae	5'- gga tca gcc cgt cct tgc tta -NH ₂ -(CH ₂) ₆ -T ₁₅ -3'
Fusarium oxysporum	5'-tag cgt agt agt aaa acc ctc gta ttc -NH ₂ -(CH ₂) ₆ -T ₁₅ -3'
Aspergillus fumigatus,	5'-cag ccg aca ccc aac ttt at cat -NH ₂ -(CH ₂) ₆ -T ₁₅ -3'
Aspergillus flavus	5'- ccg aac gca aat caa tct t aca -NH ₂ -(CH ₂) ₆ -T ₁₅ -3'
Aspergillus niger	5-ccg acg ttt tcc aac cat t caa -NH ₂ -(CH ₂) ₆ -T ₁₅ -3'
Aspergillus terreus	5'-cgc att tat ttg caa ctt gtt cat -NH ₂ -(CH ₂) ₆ -T ₁₅ -3'
Curvularia lunatus	5'-ggg tgc caa aga ctc gcc t cat -NH ₂ -(CH ₂) ₆ -T ₁₅ -3'
Alternaria alternate	5'-ata aac ctt ttg taa ttg caa tca -NH ₂ -(CH ₂) ₆ -T ₁₅ -3'
Candida albicans	5' - gg gatcgcttg acaatgg aac -NH ₂ -(CH ₂) ₆ -T ₁₅ -3'
Universal probe	5' -gca tgc atg aag aacgca gc tca -NH ₂ -(CH ₂) ₆ -T ₁₅ -3'

Table 2. Schematic Diagram of Probe Point-like Positions

1	2	3	4	5	6	13
1	2	3	4	5	6	13
7	8	9	10	11	12	13
7	8	9	10	11	12	13

1. Fusarium solani 2. Fusarium moniliforme 3. Fusarium poae
 4. Fusarium oxysporum 5. Aspergillus fumigatus 6. Aspergillus flavus
 7. Aspergillus niger 8. Aspergillus terreus 9. Penicillium implicatum
 10. Curvularia lunatus 11. Alternaria alternata 12. Candida albicans
 13. Universal probe

References

- Yang Xiaoyuan, Wang Liya, Li Zhenyong & etc. Probe into Rapid DNA Extraction Methods of Common Pathogenic Bacteria Causing Fungal Keratitis. Chinese Journal of Laboratory Medicine, 2005, 28(9): 961.
- Thomas PA. Current Perspectives on Ophthalmic Mycoses. Clinical microbiology reviews. 2003, 16 (4): 730-797.
- Gaudio PA, Gopinathan U, Sangwan V, et al. Polymerase chain reaction based detection of fungi in infected corneas. Br J Ophthalmol. 2002, 86(7): 755-760.
- Fodor S, Richard P, Xiaohua CH, et al. Multiplexed biochemical arrays with biological chip. Nature, 1993, 364: 555-556.
- Wang Liya, Zhang Yueqin, Wang Yinqi & etc. Survey on Pathogenic bacteria Causing Fungal Keratitis in Three Chinese Regions. Chinese Journal of Ophthalmology, 2000, 36(2): 138-140
- Zhao Guozhu, Zhang Tianyu, Zhang Meng. The Importance Of Ribosomal Rna Gene Cluster In The Research Of Fungal Systematics. Chemistry of Life, 2002, 22 (1):13.
- Guo Z, Guilfoyle RA, Thiel AJ, et al. Direct fluorescence analysis of genetic polymorphisms by hybridization with oligonucleotide arrays on glass supports. Nucleic Acids Research. 1994, 22(24): 5456-5465.
- Ma Liren, Jiang Zhonghua. Biochip. Chemical Industry Press Beijing 2000.
- Henry H, Iwen PC, Hinrichs SH. Identification of Aspergillus species using internal transcribed spacer regions 1 and 2. Journal of clinical microbiology. 2000, 38(4): 1510-1515.
- Wu ZH, Wang XR, Blomquist G. Evaluation of PCR condition for specific detection of common airborne fungi. J. Environ. Monit, 2002, 4: 377-382.

Interleukin-3 Receptor Alpha Chain as a Unique Marker for Leukemic Stem Cells in Acute Myeloid Leukemia

Khorshed, Amira¹; Elsharkawy, Nahla¹; Elrefaey, Fatma¹ Mansour Osman² and Elgamal, Basma*¹

¹Department of Clinical Pathology, ²Department of Medical Oncology, National Cancer Institute, Cairo University, Cairo, Egypt

*basmaelgamal@gmail.com basmaelgamal@cu.edu.eg

Abstract: Recent studies suggest that the population of malignant cells found in human acute myeloid leukemia (AML) arises from a rare population of leukemic stem cells (LSCs). In the present study, we investigated the presence of interleukin-3 receptor alpha chain in the bone marrows of 30 newly diagnosed AML cases versus 20 normal bone marrow donors as a control group; both on fresh bone marrow samples and on post culture ones. Flow cytometric study showed that the interleukin-3 receptor alpha chain was strongly coexpressed with CD34 in 91.7% of primary AML specimens and in 96% of post culture ones. Conversely, normal bone marrow derived stem cells showed virtually no detectable expression of the interleukin-3 receptor alpha chain antigen. Collectively, these data indicate that the interleukin-3 receptor alpha chain represents a unique marker for primitive leukemic stem cells. Given the strong expression of this receptor on leukemic stem cells, we propose that targeting of the interleukin-3 receptor alpha chain may be a promising strategy for detection of minimal residual disease, as well as for the preferential ablation of AML cells.

[Khorshed, Amira; Elsharkawy, Nahla; Elrefaey, Fatma, Mansour Osman; and Elgamal, Basma **Interleukin-3 Receptor Alpha Chain as a Unique Marker for Leukemic Stem Cells in Acute Myeloid Leukemia**] Life Science Journal. 2011; 8(4):68 -74] (ISSN: 1097-8135). <http://www.lifesciencesite.com>.

Key words: AML, Leukemia stem cells, IL3R α , CD123

1. Introduction

Acute myeloid leukemia (AML) is a genetically heterogeneous clonal disorder characterized by the accumulation of acquired genetic alterations in the hematopoietic progenitor cells. These alterations disturb normal mechanisms of cell growth, proliferation and differentiation resulting in the accumulation of Leukemic cells in the bone marrow, ultimately replacing most of the normal hematopoietic cells and their functions, resulting in signs and symptoms of the disease⁽¹⁾.

Acute leukemias account for approximately 2% of all cancers in the United States, but have a disproportionately large effect on cancer survival⁽²⁾. In Egypt, the incidence of acute leukemia is higher; representing 7% of newly diagnosed cancer cases, with AML accounting for 41.5% of all leukemias and 4.6% of all new cancer cases⁽³⁾.

Cancer stem cells (CSCs) are a small population of tumor cells capable of self-renewal, giving rise to all the heterogeneous components of a tumor. These cells generally represent fewer than 5% of all cells in a tumor and are believed to be tumorigenic (tumor-forming), in contrast to the bulk of cancer cells, which are thought to be non-tumorigenic. CSCs have stem cell properties such as self-renewal and the ability to differentiate into multiple cell types⁽⁴⁾. These rare cells with a self-renewal potential and the capacity to form a tumor and maintain its growth were isolated in hematological cancers such as leukemia,

multiple myeloma and a few solid tumors such as breast cancer and brain tumors. Much of the knowledge of CSC biology has come from experiments in normal and malignant hematopoiesis that led to the identification of the hematopoietic stem cell (HSC) and its malignant counterpart, the leukemia stem cell (LSC).

Interestingly, the CD34⁺CD38⁻ cell surface phenotype of LSCs is shared by immature hematopoietic precursors including HSCs, which raises the possibility that LSCs arise from HSCs. This theory provides an attractive model for leukemogenesis since the long lifespan of the HSC allows for multiple genetic hits to occur. Additionally, based on their physiologic capacity for self-renewal, HSCs would require fewer genetic hits to become LSCs than other hematopoietic cells, which must aberrantly acquire self-renewal capacity. AML can be thus viewed as newly formed, abnormal hemopoietic tissue initiated by few leukemic stem cells (LSCs) that undergo an aberrant and poorly regulated process analogous to that of normal hemopoietic cells⁽⁵⁾.

Identifying the LSCs for each type of leukemia is a current challenge and a critical step in understanding their respective biology⁽⁶⁾ and in providing a powerful diagnostic, prognostic, and therapeutic tool⁽⁵⁾.

Interleukin-3 receptor alpha chain (CD123) represents a unique marker for primitive leukemic

stem cells. Interleukin-3 is a growth factor whose main biologic activity is exerted at the level of the progenitor compartment, where this cytokine stimulates the survival and proliferation of multipotent cells. Particularly, IL-3 stimulates the development of multilineage colonies from normal bone marrow, but displays also effects at the level of the compartment of hemopoietic precursors, restricted to the granulocytic and monocytic lineages⁽⁷⁾. IL-3 promotes development of hematopoietic cells through activation of the IL-3 receptor (IL-3R) complex consisting of alpha and beta subunits. The β subunit plays a major role in signal transduction; being responsible for transmitting various intracellular signals such as activation of the Ras pathway, which is involved in the suppression of apoptosis⁽⁸⁾.

Clinically, high CD123 expression in AML is associated with higher blast counts at diagnosis and a lower complete remission rate that results in reduced survival⁽⁹⁾. The increased expression of CD123 on LSCs compared with HSCs presents an opportunity for selectively targeting AML-LSCs with a therapeutic antibody. Besides the possibility that IL-3 is required for LSC functions, an antibody to CD123 could stimulate host immune-mediated mechanisms for cell killing⁽¹⁰⁾. Thus IL-3R may be an appropriate target for cytotoxic drugs designed to selectively kill AML cells while sparing their normal hematopoietic-cell counterparts⁽¹¹⁾.

2. Subjects and Methods

Subjects: This study was carried out in the Clinical Pathology Department of the National Cancer Institute (NCI), Cairo University, where cases were randomly selected from the outpatient clinic of the Medical Oncology Department. Thirty cases of adult de novo acute non lymphatic leukemia (ANLL), fifteen males (50%) and fifteen females (50%), with male to female ratio 1:1 were incorporated in the study. Their ages ranged from 18 to 66 years with a mean of 48 years. In addition, twenty normal bone marrow age and sex matched donors; as a control group; were included.

Methods:

I- Cases were subjected to thorough history taking, full clinical examination, particularly for hepatomegaly, splenomegaly and lymphadenopathy. Complete blood picture and bone marrow aspiration as well as cytochemical stains such as Myeloperoxidase (MPO) or Sudan Black Stain (SBB), Esterases, Acid Phosphatase and PAS when indicated. Immunophenotyping was performed by Flow cytometer: to confirm the diagnosis of AML with a wide panel of myeloid markers (MPO, CD13, CD33, CD117, CD64 CD14 and CD15), lymphoid

markers (CD10, CD19, CD22, CD79a, CD20, Cyto IgM, Kappa and Lambda for B lymphoid series, and CD3, CD2, CD4, CD8, CD7 and CD5 for T lymphoid series) and the stem cell marker CD34 as well as CD56 and HLADR on routine basis. Cytogenetic examination was also done.

Response to induction therapy was assessed between days 15 and 28 after induction therapy, and follow up of cases was done for a period of at least 20 months to calculate their disease free survival and overall survival. Complete response was defined in accordance with standard criteria by **Cheson *et al.***⁽¹²⁾.

Fresh bone marrow samples were analysed at the time of diagnosis, as well as post culture samples for CD34, CD38 and CD123 as well as proper isotype control. Viable, antibody-labeled cells were identified according to their forward- and side-scattering, electronically gated and analyzed on a Flow cytometer DAKO Cytomation. The Monoclonal Ab used for the immunophenotypic detection of CD123 was RPE conjugated MoAb against the surface IL-3 receptor α chain (mouse IgG CDw123), that for the detection of CD34 was FITCI conjugated MoAb against the surface CD 34 (mouse IgG) and that for CD38 was CY5 conjugated MoAb against the surface CD 38 (mouse IgG). The antibodies were purchased from RD System Products. The technique used for the detection of the three surface markers was the direct staining technique.

Bone Marrow Sample Culture

Fresh bone marrow samples were cultured for 3 days in 37°C/CO₂ incubator. The BM samples were added to a tissue culture graduated flasks containing 10 ml of the culture media, which was prepared via dividing 100 ml of fetal calf serum and 7ml tetracycline, ampicillin and penicillin as antibiotics and 15 ml L glutamine to 4 flasks each containing 100 ml of RPMI medium (provided by GIBCO, lot number 21875) and 5ml of Alpha Minimum Essential Medium α MEM (provided by GIBCO, lot number 22561). After the 3 days, the cultured samples were analyzed in the same manner like the fresh samples.

Statistical Methods:

Data was analyzed using SPSS win statistical package version 17 (SPSS Inc., Chicago, IL). Numerical data were expressed as mean and standard deviation or median and range as appropriate. Qualitative data were expressed as frequency and percentage. Chi-square test (Fisher's exact test) was used to examine the relation between qualitative variables. For quantitative data, comparison between two groups was done using Mann-Whitney test (non parametric t-test). Comparison of repeated measures

was done using Friedman test followed by Wilcoxon signed-ranks test. Spearman-rho method was used to test correlation between numerical variables. The Receiver Operating Characteristic (ROC) curve was used for prediction of cut off values. A p-value < 0.05 was considered significant.

3. Results:

This study included thirty cases of newly diagnosed adult acute non lymphatic leukemia (ANLL) presenting to the Medical Oncology Department of the National Cancer Institute (NCI), Cairo University. The median age of cases in our study was 48 years with a mean of 44.6 ± 15 years (range 18 - 66 years). Sex distribution was 15 males (50%) and 15 females (50%). Hepatomegaly was encountered in 96.7% of cases, splenomegaly in 86.7% of cases and lymphadenopathy in 100% of cases. In addition, twenty normal bone marrow age and sex matched donors; as a control group; were included.

The presenting total leucocytic count in patients ranged from 1.4 to 66.8 with a mean of 40.3 ± 18.3 and a median of 47.7×10^9 /L. The control group showed a mean of $7.5 \pm 1.3 \times 10^9$ /L. The difference between patients and controls was found to be statistically significant ($P = 0.001$). The platelet count in patients ranged from 8.0 to 87.00 with a mean of 43.1 ± 22.88 , and a median of 43.5×10^9 /L, while the control group showed a mean of $275.1 \pm 73.27 \times 10^9$ /L. The difference between patients and controls was found to be statistically significant ($P=0.001$). Hemoglobin in patients ranged from 5.8 to 9.1, with a mean of 6.5 ± 1.8 , and a median of 6.8 gm/dl, while the control group showed a mean of 12.8 ± 0.7 gm/dl. The difference between patients and controls was found to be statistically highly significant ($P < 0.001$). Blasts in peripheral blood were detected in the 24 out of 30 patients (80 %). The mean percentage of blasts in peripheral blood was $18.1\% \pm 18.1$; the median was 16% and the range was 0-62 %. On bone marrow examination, twenty three patients out of 30 (76.7%) had $\geq 50\%$ leukemic cells encroaching on their normal hematopoietic cells while seven ones (23.3%) had $<50\%$ leukemic cells. The mean percentage of blasts in marrow was $66.6\% \pm 27.4$, the median was 74% and the range was 23-99%.

The myeloid lineage markers including CD13, CD33 and MPO were detected on thirty patients (100%), myeloid with monocytic markers including CD14, CD64, CD4 were detected on six out of 30 (20%) of patients and myeloid markers with aberrant expression of lymphoid markers were detected on one out of 30 patients (3.3%). Conventional cytogenetic study was done to the 30 patients. Fourteen cases out of 30 (46.6%) were of normal karyotype. One out of

30 cases (3.3%) was positive to t (15:17), four cases out of 30 (13.3%) were positive to inv (16) and nine out of 30 cases (30%) were positive for t (8:21). While two cases out of 30 (6.7%) showed different cytogenetic abnormalities which were -20, +21, del11q23 and -14. Cytochemistry was done for all cases. According to FAB classification the cases included 6 cases (20%) M1; 16 cases (53.3%) M2; 1 case (3.3%) M3; 4 cases (13.3%) M4 (1 M4 and 3 M4 with abnormal eosinophils ; 2 cases (6.6%) M5 (1 M5a and 1 M5b) and one case M7 (3.3%).

Patients were followed up for a period of at least 20 months. Seven out of thirty (23.3%), died from leukemia and chemotherapy. Twenty three (76.7%) were alive by the end of the study period. Six out of thirty (20%) had complete remission (CR), while seventeen (56.7%) had CR followed by relapse (R). Tables (1 and 2) show the range, the median, the mean and the SD of expression of CD123, CD34, CD38 and CD34/CD38 coexpression in AML patients versus the control group (pre and postculture respectively). Tables (3 and 4) show the range, the median, the mean and the SD of mean fluorescent intensity of CD123, CD34, CD38 and CD34/CD38 coexpression in AML patients versus the control group (pre and postculture respectively). Figure (1) shows AML cases with positive coexpression of CD34 and CD123.

The cut off values of CD 34 & CD 123 were determined by the ROC curve to determine the level which gives the best discrimination between the positive and negative taking the control as a negative value. The determined cut off values was $\geq 1.45\%$ for CD34, $\geq 0.768\%$ for CD123 and ≤ 1.4850 for MFI 123. For the freshly examined samples, twenty four out of thirty (80%) cases had CD34% expression above the cut off value $\geq 1.45\%$. Twenty two out of thirty (73.3%) cases had CD123% expression above the cut off value $\geq 0.768\%$. Twenty two out of twenty four (91.7%) cases had coexpression of CD123% and CD34% above the cut off values $\geq 0.768\%$ and $\geq 1.45\%$ respectively. For the post culture samples, twenty five out of twenty seven (92.6%) post culture cases had CD34% expression above the cut off value $\geq 1.45\%$. Twenty four out of twenty seven (88.9%) post culture cases had CD123% expression above the cut off value $\geq 0.768\%$. Twenty four out of twenty five (96%) cases had coexpression of CD123% and CD34% above the cut off values $\geq 0.768\%$ and $\geq 1.45\%$ respectively. Twenty one out of twenty seven (77.8%) post culture cases had MFI 123 expression below the cut off value ≤ 1.4850 .

One out of twenty four (4.17%) cases having CD34 expression above the cut off value $\geq 1.45\%$ was in CR. However, five out of six (83.33%) cases having CD34 expression below the cut off value

$\geq 1.45\%$ were in CR. The difference was found to be statistically highly significant ($P < 0.001$). None out of twenty two cases (0%), having CD123 expression above the cut off value $\geq 0.768\%$, were in CR. However, six out of eight (75%) cases, having CD123 expression below the cut off value $\geq 0.768\%$, were in CR. The difference was found to be statistically highly significant ($P < 0.001$). One out of twenty one

(4.77%) cases, having MFI 123 expression below the cut off value ≤ 1.4850 , was in CR versus five out of six (83.33%) cases, having MFI expression above the cut off value ≤ 1.4850 , that were in CR. The difference was found to be statistically highly significant ($P < 0.001$).

Table (1): Expression of CD123, CD38, CD34 & CD34/CD38 coexpression in AML cases and controls in fresh samples

		CD123%	CD38%	CD34 ⁺ /CD38 ⁻ %	CD38 ⁺ /CD34 ⁺ % coexpression
AML (30)	Mean \pm SD	10.2 \pm 16.3	24.2 \pm 26.7	8.7 \pm 10.1	23.0 \pm 27.0
	Median	4.3	10.9	5.5	7
	Range	0.1- 60.2	2.0- 88.9	0.1- 38.3	0.0- 87.0
Controls (20)	Mean \pm SD	0.6 \pm 0.5	3.5 \pm 1.7	1.4 \pm 1.3	1.0 \pm 1.0
	Median	0.5	3.3	1.1	1.0
	Range	0.1- 1.6	0.5- 6.0	0.1- 3.9	0.0- 5.0
P value		<0.001	<0.001	0.001	0.001

Table (2): Expression of CD123, CD38, CD34 & CD34/CD38 coexpression in AML cases and controls in post culture samples

		CD123%	CD38%	CD34 ⁺ /CD38 ⁻ %	CD38 ⁺ /CD34 ⁺ % coexpression
AML (27)	Mean \pm SD	15.3 \pm 14.1	17.7 \pm 13.5	14.5 \pm 13.4	34.1 \pm 29.7
	Median	13.6	12.8	12.0	21.6
	Range	0.1- 56.5	2.3- 48.0	0.7- 48.0	0.2- 92.3
Controls (20)	Mean \pm SD	1.1 \pm 0.9	2.1 \pm 2.7	1.0 \pm 1.0.	0.4 \pm 0.5
	Median	0.8	0.9	0.7	0.2
	Range	0.1- 2.9	0.1- 7.5	0.0- 3.4	0.0- 0.5
P value		<0.001	<0.001	0.012	<0.001

Table (3): Mean fluorescent intensity of CD123, CD38, CD34 & CD34/CD38 Coexpression in AML cases and controls in fresh samples

		CD123 flow intensity	CD38 flow intensity	CD34 ⁺ /CD38 ⁻ flow intensity	CD38 ⁺ /CD34 ⁺ coexpression flow intensity
AML (30)	Mean \pm SD	1.52 \pm 1.26	0.692 \pm 0.566	1.71 \pm 1.55	3.2 \pm 3.5
	Median	1.15	3.58	1.15	3.0
	Range	0.14 - 5.13	0.167 - 3.18	0.12 - 6.56	0.4 - 12.8
Controls (20)	Mean \pm SD	2.06 \pm 1.15	0.42 \pm 0.16	1.91 \pm 0.68	2.9 \pm 1.2
	Median	1.78	1.60	1.79	3.76
	Range	0.75 - 4.94	0.90 - 5.07	0.49-2.9	0.8 - 4.4
P value		0.072	0.095	0.794	0.259

Table (4): Mean fluorescent intensity of CD123, CD38, CD34 & CD34/CD38 Coexpression in AML cases and controls in post culture samples

		CD123 flow intensity	CD38 flow intensity	CD34 ⁺ /CD38 ⁻ flow intensity	CD38 ⁺ /CD34 ⁺ coexpression flow intensity
AML (27)	Mean \pm SD	1.5 \pm 1.35	0.81 \pm 0.72	1.65 \pm 1.1	3.18 \pm 2.5
	Median	0.90	2.71	1.94	3.98
	Range	0.40 - 4.32	0.13 -3.95	0.13-5.44	0.15 -11.6
Controls (20)	Mean \pm SD	1.8 \pm 1.4	0.64 \pm 0.20	1.37 \pm 0.67	3.72 \pm 2.54
	Median	1.72	0.605	1.21	2.76
	Range	0.38-4.78	0.34 - 1.0	0.36-2.58	1.53 -9.28
P value		0.013	0.827	0.555	0.555

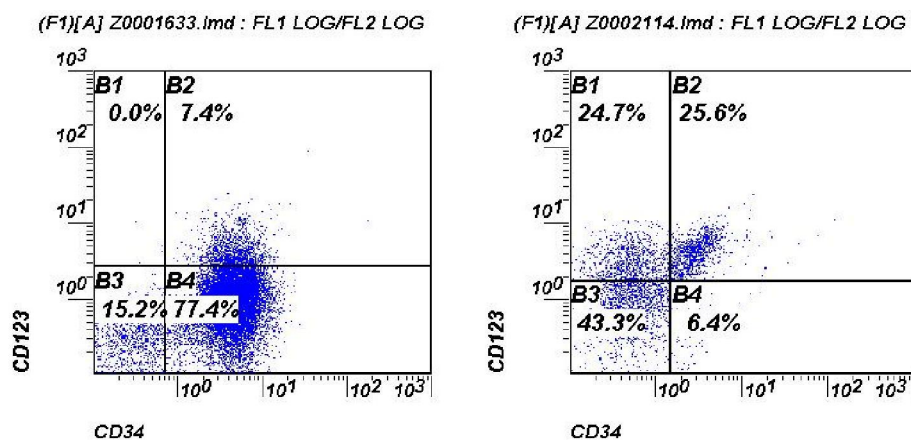

Fig (1): AML cases with positive expression of CD34 and coexpression of CD123 (fresh samples left and post culture right).

4. Discussion

The outcome of adults with AML varies based on a variety of well-defined factors including age of the patient, intensity of post remission therapy (in younger adults), and biologic characteristics of the disease. The karyotype at diagnosis, the presence of transmembrane transporter proteins; which confer multidrug resistance; and mutations or overexpression of specific genes are among the most common factors affecting the disease outcome⁽¹³⁾. In this work, cases were classified according to the FAB classification criteria⁽¹⁴⁾, based on morphological and cytochemical characteristics. The most commonly encountered FAB subtype was M2 (53.3%), followed by M1 (20%), M4 (13.3%), M5 (6.6%) and finally both M3 (3.3%) and M7 (3.3%).

Several recent studies have suggested the presence and importance of stem cells in both the genesis and perpetuation of AML. Phenotypically, cells described as CD34⁺/CD38⁻ or CD34⁺/HLA-DR⁻ appear to play a central role in the development of leukemic populations. Furthermore, there is evidence suggesting that such cells may be relatively resistant to chemotherapeutic drugs, and consequently contribute to the phenomenon of relapse. The study of cytokine receptor expression by flow cytometry could allow differentiation between normal and tumor cells. Tumor cells show high expression of IL-3R α chain (CD123) in hematologic malignancies compared to normal precursors⁽¹⁵⁾. In the study done by Jordan, identification of CD 123 among CD34⁺/CD38⁻ AML stem cells facilitates their discrimination from normal hematopoietic stem cells⁽¹⁶⁾. The conserved expression of this molecule on AML specimens examined suggests that it is related to a central aspect of AML biology.

Several lines of evidence suggest that the autonomous proliferation of leukemic blasts may be

related to autocrine mechanisms of HGF production or to constitutive activation of the signal transduction machinery triggered by HGFR⁽⁷⁾. In this study, IL-3R α was over expressed in AML cases versus controls. Correlation of IL-3R α over expression with the clinical, hematological and immunophenotypic parameters in our AML cases showed that it was not related to particular sex or age. There were no significant differences in IL-3R α levels with respect to the initial Hb level, platelet count at presentation and bone marrow cellularity. To the best of our knowledge, no previous studies addressed the correlation of the previous parameters with IL-3R α expression in AML cases. In the present work, there was no significant difference in IL-3R α expression levels with respect to the FAB subtypes. This finding was also reported by *Testa et al.*⁽¹⁷⁾. However the increase in IL-3R α expression was significantly associated with TLC $\geq 50 \times 10^9/L$ (p-value = 0.001). Similar results were documented by *Testa et al.*, in which IL-3R α was over expressed at both gene and protein level in about half of the cases of AML patients, and IL-3R α over expression correlated with high leukocytic count⁽¹⁷⁾. In this work out of 30 patients, 22 belonged to the group of patients with high IL-3R α expression while 8 patients belonged to the group of patients with low IL-3R α expression; the median WBC count at presentation was significantly higher in patients with elevated IL-3R α levels than in those with low IL-3R α levels, suggesting a role for IL-3R α in leucocyte proliferation/survival.

The present work did not reveal any significant differences in IL-3R α levels with respect to the peripheral blood blasts percentage. Contrary to this finding, *Testa et al.*, and *Riccioni et al.*, reported that the level of IL-3R α chain expression is directly correlated with the number of leukemic blasts present in the peripheral blood at diagnosis^(17, 18). In the

present study, IL-3R α over expression was significantly associated with bone marrow blasts percentage $\geq 50\%$ (p-value =0.002). The same results had been documented by **Testa et al.**, and **Riccioni et al.**, in which IL-3R α was over expressed in about half of the cases of AML patients and was correlated with high bone marrow blasts percentage detected at diagnosis^(7,18). In their reports, **Testa et al.**, discussed two sets of independent observations suggesting that elevated IL-3R α chain expression may have a role in the proliferation of leukemic cells⁽⁷⁾. The first was that a direct correlation was observed between the level of IL-3R α chain and the number of leukemic blasts observed at diagnosis. The second was that elevated IL-3R α expression represented a negative prognostic factor and is associated with shorter survival and had explored a possible effect of elevated IL-3R α expression on Stat5 activation.

In the present study, there was a significant difference in IL-3R α levels with respect to the early treatment response (CR, No CR and death). None of the cases examined at this work were having CD123 expression above the cut off value $\geq 0.768\%$, were in CR. On the other hand 75% of cases, having CD123 expression below the cut off value $\geq 0.768\%$, were in CR. The difference was found to be statistically highly significant (P <0.001), similar to **Testa et al.**, and **Riccioni et al.**, who reported a significant difference in the induction response rate, with a significantly higher rate of complete remissions in the low IL-3R α group as compared to the high IL-3R α group^(7,17,18). They also reported that the relapse rate was significantly higher with higher IL-3R α . This finding might suggest a prognostic value of IL-3R α in AML patients. A significant correlation was found between CD34 expression and IL-3R α expression levels among AML cases. IL-3R α expression was significantly higher in CD34+ve compared to CD34-ve leukemic blasts, (p-value <0.001) similar to **Testa et al.**⁽⁷⁾. 91.7% of preculture cases had coexpression of CD123% and CD34% and 96% of postculture cases had coexpression of CD123% and CD34%.

In conclusion, we have shown that the presence of CD123 on AML cells has several important ramifications. First, expression of this antigen formally demonstrates that LSCs are biologically distinct from their normal stem cell counterparts. Second, because CD123 is not readily found on normal hematopoietic stem cells, it provides a unique marker that can be used to identify malignant tissue. This feature may be useful for detection of minimal residual disease (MRD). Further, the CD123 epitope represents a target to which therapeutic strategies may be directed.

Acknowledgements

This study was supported in part by grants from the National Cancer Institute, Cairo University. We thank our patients for their willing participation in our research. Disclosure statement: The authors declared no conflicts of interest.

Corresponding author

Elgamal, Basma
Department of Clinical Pathology, National Cancer Institute, Cairo University, Cairo, Egypt.
basmaelgamal@gmail.com
basmaelgamal@cu.edu.eg

References

1. Mrozek K, Marcucci G, Paschka P, *et al.* (2007): Clinical relevance of mutations and gene expression changes in adult acute myeloid leukemia with normal cytogenetics: are we ready for a prognostically prioritized molecular classification. *Blood.*; 109: 431- 448.
2. Bozzone DM. (2009): *The Biology of Cancer: Leukemia.*; Chelsea house, An imprint of InfoBase Publishing, New York.
3. National Cancer Institute (NCI) registry(2004): National Cancer Institute statistics 2004. Department of Biostatistics and Cancer Epidemiology, NCI Cairo; 63-66.
4. Al-Hajj M., Wicha M.S., Benito-Hernandez A., *et al.* (2003): Prospective Identification of Tumorigenic Breast Cancer Cells. *Proc Natl Acad Sci., USA*; 100:3983–3988.
5. Cho RW and Clarke MF(2008): Recent advances in cancer stem cells. *Curr Opin Genet Dev.*; 18(1):48-53.
6. Passegue E., Jamieson C.H., Ailles L.E., *et al.* (2003): Normal and leukemic hematopoiesis: are leukemias a stem cell disorder or a reacquisition of stem cell characteristics? *Proc Natl Acad Sci USA*; 100:11842–11849.
7. Testa U, Riccioni R, Diverio D, *et al.* (2004): Interleukin-3 receptor in acute leukemia. *Leukemia.*; 18:219–226.
8. Chen J, Olsen J, Ford S, *et al.* (2009): Young IGA new isoform of interleukin-3 receptor {alpha} with novel differentiation activity and high affinity binding mode. *J Biol Chem.*, 284(9):5763-73.
9. Graf M, Hecht K, Reif S, *et al.* (2004): Expression and prognostic value of hemopoietic cytokine receptors in acute myeloid leukemia (AML): implications for future therapeutic strategies. *Eur. J. Haematol.*; 72: 89–106.
10. Jin L, Erwin ML, Hayley SR, *et al.* (2009): Monoclonal Antibody-Mediated Targeting of CD123, IL-3 Receptor α Chain, eliminates human

- acute myeloid leukemic stem cells. *Cell Stem Cell.*, 5: 31–42.
11. Yalcintepe L, Arthur E, Frankel, *et al.* (2006): Expression of interleukin-3 receptor subunits on defined subpopulations of acute myeloid leukemia blasts predicts the cytotoxicity of diphtheria toxin interleukin-3 fusion protein against malignant progenitors that engraft in immunodeficient mice. *Blood*, 108(10):3530-3537.
 12. Cheson BD, Cassileth PA, Head DR, *et al.* (1990): Report of the National Cancer Institute-sponsored workshop on definitions of diagnosis and response in acute myeloid leukemia. *J Clin Oncol.*, 8:813–819,
 13. Tallman MS.(2005): New strategies for the treatment of acute myeloid leukemia including antibodies and other novel agents, *Hematology . Am Soc Hematol Educ Program.*; 143-50.
 14. Bennett JM, Catovsky D, Daniel MT, *et al.* (1991): Proposals for the recognition of minimally differentiated acute myeloid leukemia (AML-MO). *Br J Haematol.*; 78:325–329.
 15. Munoz L, Nomdedéu JF, López O, *et al.* (2001): Interleukin-3 receptor α chain (CD123) is widely expressed in hematologic malignancies. *Haematologica*; 86:1261-1269.
 16. Jordan CT.(2002): Unique molecular and cellular features of acute myelogenous leukemia stem cells. *Leukemia* ; 16:559-62.
 17. Testa U, Riccioni R, Militi S, *et al.* (2002): Elevated expression of IL-3R alpha in acute myelogenous leukemia is associated with enhanced blast proliferation, increased cellularity, and poor prognosis. *Blood.*; 100:2980–2988.
 18. Riccioni R, Rossini A, Calabrò L, Diverio D, Pasquini L, Lococo F, Peschle C and Testa U. (2004): Immunophenotypic features of acute myeloid leukemias overexpressing the interleukin 3 receptor alpha chain. *Leuk Lymphoma.* 45(8):1511-7.

9/22/2011

Aflatoxins Binding by *Saccharomyces Cerevisiae* and *S. boulardii* in Functional Cereal Based Ice-cream

Eman M. Hegazy¹, Zeinab I. Sadek², Kawther El-Shafei² and Azzat B. Abd El-Khalek²

¹Food Toxicology and contaminants Department and ²Dairy Science Department, National Research Centre, Dokki, Cairo, Egypt

Abstract: The ability of *Saccharomyces cerevisiae* and *S. boulardii* (viable or nonviable) to bind aflatoxins (B₁, B₂, G₁ and G₂) in liquid medium, cereals extracts and ice-cream at different temperatures and times was detected. Viable *S. cerevisiae* showed the highest binding of aflatoxins (AFS). Highest AFS binding capacity (74.7%) was obtained by viable cells of *S. cerevisiae* when incubated at 8°C for eight hours. While, binding was not affected by the cells of *S. boulardii* (viable or nonviable) at 25°C. *S. cerevisiae* when inoculated in barley extract bound 80% of added total AFS, but it found to be 60% in wheat extract. In addition, that the *S. cerevisiae* binding AFS in chocolate and vanilla ice-cream supplemented with barely extract. Sensory evaluation appeared that the chocolate ice cream with barley extract and viable *S. cerevisiae* was highly accepted for appearance, texture, taste and odor. No changes were detected in microbiological examination in ice-cream after three months storage.

[Eman M. Hegazy, Zeinab I. Sadek, Kawther El-Shafei and Azzat B. Abd El-Khalek **Aflatoxins Binding by *Saccharomyces Cerevisiae* and *S. Boulardii* in Functional Cereal Based Ice-Cream**]. Life Science Journal. 2011; 8(4): 75-81] (ISSN: 1097-8135). <http://www.lifesciencesite.com>.

Key words: aflatoxins binding, *Saccharomyces cerevisiae*, *S. boulardii*, cereal extracts, barley, wheat, ice-cream.

1. Introduction

Mycotoxins are secondary metabolites produced by various moulds of which *Aspergillus*, *Penicillium* and *Fusarium* are the most common genera. Fungal contamination of plants can occur in the field on contaminated seeds or during growth, or at transport and storage in certain environmental conditions. The level of mycotoxin contamination in fields varies according to the plants and depends of climatic conditions, which is explained by large differences between years (Richard-Molard, 1999).

Aflatoxins (B₁, B₂, G₁ and G₂) are group of closely related difuranocoumarin compounds produced by several fungi, mainly *Aspergillus flavus* and *A. parasiticus* (Steyn, 1995). These fungi produce aflatoxins, contaminating a number of crops bound to human consumption such as corn, sorghum, rice, wheat, and nut (Cleveland *et al.*, 2003). Aflatoxins contamination occurs by colonization of the fungus on susceptible crop, or may arise during harvesting, drying, storage or processing. Concerns related to the negative health impact of aflatoxins have led to the investigation of strategies to prevent, eliminate or reduce the presence of these toxins in contaminated products.

Saccharomyces cerevisiae, is the most common yeast used in food fermentation where it has shown various technological properties. Also, yeasts play a significant role in the spontaneous fermentation of many indigenous food products (Jespersen, 2003), he also added several beneficial effects on human health and well-being. Moreover, *Saccharomyces boulardii* is the only yeast with clinical effects and the only yeast preparation with

proven probiotic efficiency in double-blind studies (Sazawal *et al.*, 2006).

Cereals have been investigated regarding their potential use in developing functional foods, which are grown over 73% of the total world harvested area and contribute over 60% of the world food production providing dietary fiber, proteins, energy, minerals and vitamins required for human health (Charalampopoulos *et al.*, 2002).

New applications of probiotic microorganisms such as yeasts in foods have been introduced into the market or are still in the development phase, such as frozen yoghurt, soy yoghurt, dairy desserts, cheese, ice-cream, bread and chocolate (De Vuyst, 2000).

The aim of this work was to study the ability of *S. cerevisiae* and *S. boulardii* to bind aflatoxins at refrigerator and room temperature in phosphate buffered saline (PBS), barley or wheat extracts and ice-cream, also, detect the microbiological quality and sensory evaluation of fresh functional cereal based ice-cream supplemented with *S. cerevisiae* and barley extract then after three months of storage.

2. Materials and Methods

Yeast strains

Pure culture of *Saccharomyces cerevisiae* (Baker's yeast) was obtained from Al-Hawamdia Company fresh comprised yeast according to the Egyptian standard (191/2005).

Saccharomyces boulardii was obtained from Microbial Genetic Department, National Research centre, Dokki, Giza, Egypt. Strains grown in malt yeast extract glucose peptone (MYGP) tubes for 24h at 25°C.

Aflatoxins (B₁, B₂, G₁ and G₂) standard was obtained from Sigma chemical company. USA.

Production of yeast biomass

S. cerevisiae or *S. boulardii* were cultured in flasks containing a Yeast Peptone and Glucose (YPG) medium W/V (1% yeast extract, 2% bacteriological peptone and 2% glucose) at 30°C, shaken at 200 rpm for 24 h. Supernatant and pellet fractions were separated by centrifugation (4000 for 5 min) yeast cells were washed twice with buffer peptone solution (PBS pH 6.0), then cells of the two strains were divided into two parties viable and nonviable (heat-treated at 60°C for 10 min) (Bejaoui *et al.*, 2004)

Cereals

Good quality of barley and wheat grains free from any toxin were obtained from the Agricultural Research Center Ministry of Agriculture, Egypt.

Barley and wheat grains were ground in a Laboratory Falling Number hammer mill with a sieve of size 0.5mm, 50g, and mixed with 40ml distilling water, then centrifuged at 5000g for 30 min, finally the supernatant was collected and pasteurized at 70°C for 20 sec. (Charalampopoulos *et al.*, 2002).

Detection of Aflatoxins

Aflatoxins (B₁, B₂, G₁ and G₂) were detected according to the method of AOAC (2007), qualitatively by thin layer chromatography following by quantitative method. Detection of toxin was performed using high performance liquid chromatography. Data were integrated and recorded using a Millennium chromatography. Manger Software 2010 (Waters, Milford MA 01757).

Ice-cream Preparation

Vanilla, chocolate, strawberry and mango ice-cream powder (full fat milk powder, sugar, stabilizer, emulsifiers, palm kernel and coconut oil) were prepared by adding 20% of barley or wheat extracts or milk and the mixtures were whipped with electric mixture at high speed within 3min. The whipped mixture was hardened in freezer at -18°C and stored for three months.

Binding ability of yeasts to aflatoxins in Phosphate Buffered Saline (PBS)

Two percent of *S. cerevisiae* as well as *S. boulardii* viable or nonviable were placed in flasks with 20 µg/L aflatoxins (B₁, B₂, G₁ and G₂) with 100ml PBS buffer, then were incubated at temperature 8°C (refrigerator) or 25°C (room temperature). Aflatoxins were detected after 0.5, 1, 2, 4, 6, 8, 10, 12 and 24 h, according to the method

performed by modifying of Shetty *et al.* (2007). After incubation, the flasks were centrifuged and the aflatoxins were detected in the supernatants.

Binding ability of *S. cerevisiae* to AFS in cereals extract

Two percent of *S. cerevisiae* (viable) with 20 µg/L of aflatoxins and 100 ml of barley or wheat extracts were incubated in refrigerator at 8°C for 12 h, then the residue of aflatoxins were detected by HPLC method and calculated the binding of AFS.

Binding ability of *S. cerevisiae* to AFS in ice-cream

Different flasks contain 500 ml barley or wheat extracts or milk were inoculated with 2% of *S. cerevisiae* (viable) and 20µg/L of aflatoxins and were incubated in refrigerator at 8°C for 12 h, then, ice-cream powder (Vanilla, chocolate, strawberry and mango) were added, whipping with electric mixture at high speed within 3min then were hardened in freezer at -18°C to evaluate aflatoxins binding.

Microbiological examination

Total bacterial counts in fresh ice-cream mixtures and after three months of storage (at -18°C) were counted on plate count agar (Oxoid). Plates were incubated at 37°C for 48 h under aerobic conditions for mesophilic microorganism and at 7°C for 10 days for total aerobic psychrophilic microorganisms. Colony-forming units were counted (cfu / ml) and the results expressed as their log₁₀ values (FDA, 1992). Yeast counts were determined on malt extract agar (Oxoid) supplemented with tetracycline at final concentration of 10mg/liter, plates were incubated at 25°C for 5 days (Sarais *et al.*, 1996). Spore formers were determined by heating the sample dilution (10⁻¹) in water-bath for 10 min at 80-85°C as described by Meer *et al.* (1991), then plated on plate count agar supplemented with 0.1% soluble starch, incubated at 37°C for 18 h for mesophilic spore former and at 10°C for 7 days for psychrophilic sporeformer.

Sensory evaluation of ice-cream

Samples of prepared ice-cream (Vanilla, chocolate, strawberry and mango) supplement by barley or wheat extracts or milk with 2% *S. cerevisiae* (viable) were evaluated by fifteen members of laboratory staff. Quantitative descriptive analysis (QDA) was used to determine differences in the sensory characteristics of the ice-cream with barley, wheat extract or milk. The panelists evaluated the texture, appearance, color, taste, odor and overall acceptability on unstructured 10 line scales verbally anchored at each end. The results from the linear scale were subsequently converted to numerical

values (from 0 to 10 units) by a computer. The panelists were also asked to evaluate the overall acceptability of the ice cream with barley, wheat and ice cream with milk on the basis of texture, appearance, color, taste, odor and overall acceptability. An unstructured graphical scale was anchored on both ends: not accept (0)-fully accept (10) (Meligaard *et al.*, 1991).

Statistical analysis

Results of sensory evaluation of ice-cream with barley, wheat and milk were subjected to statistical analysis of variance and least significant differences (LSD) as described by Rao and Blane (1985).

3. Results and Discussion

Binding ability of yeasts to aflatoxins in PBS buffer

Binding ability of yeasts to aflatoxins in PBS buffer medium at 8°C and 25°C at different times were illustrated in Figs 1-3. Fig. 1 showed the AFS binding by viable cells of *S. cerevisiae* when incubated at 8°C for 12 h was 74.70%. While non-viable yeast *S. cerevisiae* had low binding effect. Our results were not agreement with Shetty *et al.* (2007) who found that aflatoxin binding by *S. cerevisiae* was not affected by the cells grown at temperatures ranging from 20 to 37°C but was significant and reduced at 15°C, and added that bending seems to be a physical phenomenon with cells treated at 52, 55 and 60°C for 5 and 10 min or auto calving the cells at 120°C for 20 min (non-viable) which recorded 77.7% binding. On the other hand, total AFS binding by *S. boulardii* at 8°C in YPG medium, results showed that non-viable cells had no effect or binding AFS, but, viable cells binding 18% of AFS after incubated for 6h (Fig. 2). Regarding to the data in Fig. 3 shows that viable cells of *S. cerevisiae* could bind AFS at 25°C.

Appears specific nature of binding, after 4h binding 73.18% AFS but after 8h release the AFS or clean the cells from AFS binding. Fig. 3 also shows that non-viable cells of *S. cerevisiae* binding 30.91% AFS after 8h. Finally, binding was not affected by the cells of *S. boulardii* (viable or nonviable) which grown at 25°C in YPG medium. These results due to the fact that, *S. boulardii* from a taxonomic point of view should not be recognized as a separate species, *S. boulardii* will in the following be referred to as *S. cerevisiae*. It is worth to notice that contrary to e.g., probiotic strains of lactic acid bacteria, apparently these seems not to be different strains *S. cerevisiae*. Based on the similarity in different molecular analyses, Van der Aa Kiihle and Kiihle, (2003).

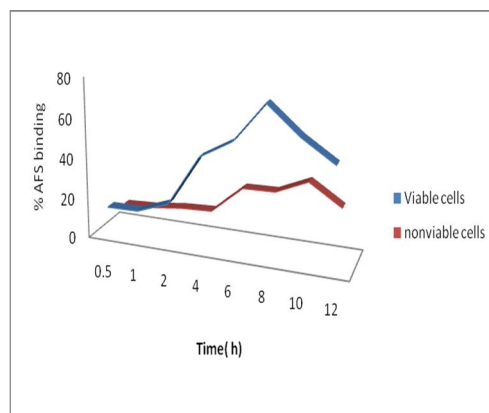

Fig (1). Total aflatoxins binding (%) by *S. cerevisiae* in YPG medium at 8°C

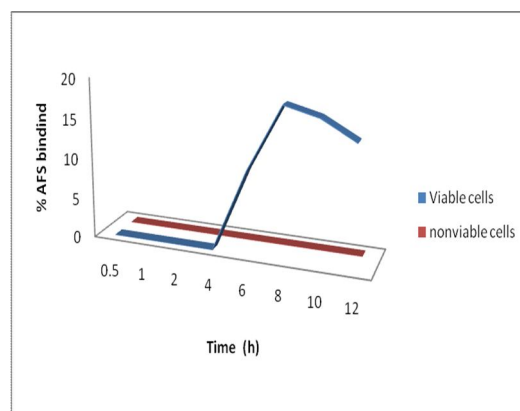
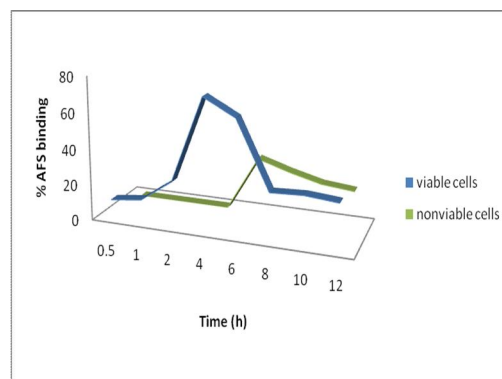

Fig (2). Total aflatoxins binding (%) by *S. boulardii* in YPG medium at 8°C



Fig(3). Total aflatoxins binding (%) by *S. cerevisiae* in YPG medium at 25°C

However, evidences from the poultry feeding experiments have shown that the yeast cell wall-aflatoxin complex can efficiently pass through the gut, resulting in protection from aflatoxin induced toxicities (Santin *et al.*, 2003). In these respect

Bueno et al (2007) studied the physical adsorption of aflatoxin B₁ (AFB₁) by lactic acid bacteria and *S. cerevisiae* from liquid medium the experimental results indicated the AFB binding to microorganisms was a rapid process and this binding involved the formation of a reversible complex the toxin and microorganism surface, considering that the binding (adsorption) and release desorption of AFB₁ to and from the site on the surface of the microorganism took place (AFB₁+S \longleftrightarrow S-AFB₁).

These observations were in agreement with **Guo et al. (2005)** who suggest that DNA in yeast *Saccharomyces cerevisiae* was damage tolerance pathways and are important in triggering AFB₁ associated recombination and mutation. So, recombinational or mutagenic pathways are selected in unclear. In addition, (**Shetty et al., 2007**) *S. cerevisiae* cells were capable of binding high amounts of aflatoxin B₁ at high concentration (20 µg/ml). The binding was still not saturated showing the high efficiency of strains. This indicates that *S. cerevisiae* have a great-potential as aflatoxin binders in food and the nature of cell wall components involved in mycotoxin binding is still not clear and carbohydrate rich mannoproteins or glucans may be the likely candidates involved in the binding.

Binding ability of *S. cerevisiae* to AFS in cereals extract

Obtained results revealed that the best yeast was *S. cerevisiae* to bind AFS at 8°C for 8h in YPG medium then data obtained by HPLC showed that *S. cerevisiae* growth in barley extract bound 80% of added total AFS, with 60% in wheat extract. These observation were in agreement with (**Charalampopoulos et al., 2002**) who suggest this could be attributed to the simultaneous presence of considerable amounts of monosaccharide (glucose and fructose) and disaccharides (maltose and sucrose) in the barley medium. Also **Taillandier et al. (1996)** and **Elli et al. (1999)** found usually exhibiting poor growth in synthetic media without the addition of large amounts of supplements, such as yeast extract and peptone.

Binding ability of *S. cerevisiae* to AFS in cereal extracts ice-cream

As shown in Figures 4 and 5 *S. cerevisiae* binding AFS in chocolate and vanilla ice-cream with barley extract which may be due to the present of fat and protein in chocolate at high concentration than other types of ice-cream.

Determined 2.23 mg/ml AFM₁ of ice-cream in Nigeria by **Atanda et al. (2007)**. He also, added the concentration of AFB₁ in feed which is transformed to AFM₁ in milk should be reduced by good

manufacturing and good storage practices. Furthermore, there is need for stringent quality control during processing and distribution of these products.

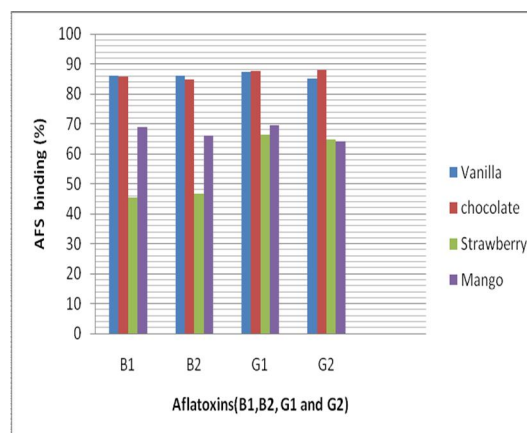

Fig (4). Binding ability of *S.cerevisiae* to AFS in barley extract ice- cream

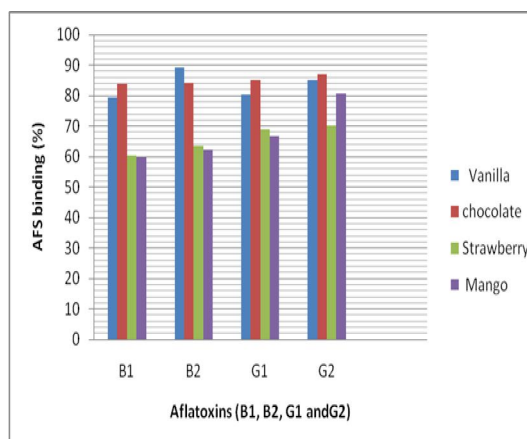

Fig (5). Binding ability of *S.cerevisiae* to AFS in wheat extract ice-cream

Microbiological examination

Fresh and stored samples of ice-cream supplemented with barley, wheat extracts as well as milk and inoculated with *S.cerevisiae* were analyzed for total bacterial count, psychrophilic bacterial, mesophilic and psychrophilic sporeformers and yeast counts (Figs. 6-9)

The obtained results in Figures 6, 7, and 8, showed similar trend of the results of total viable mesophilic aerobic bacterial and psychrophilic bacterial count. Also, the yeast count showed that these was not pronounced different counts among the all ice-cream samples. While, both mesophilic and psychrophilic sporeformers bacterial were not detected in any of ice-cream samples.

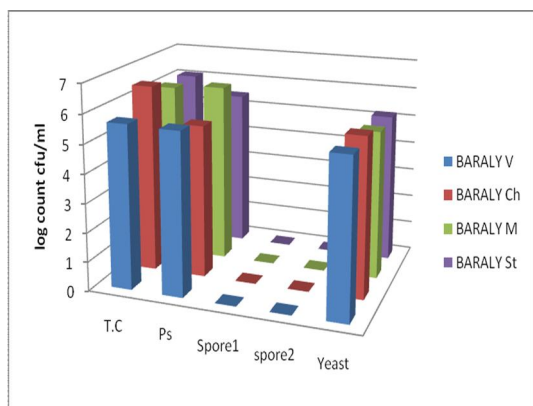

Fig (6). Microbiological examination of fresh barley ice-cream

T.C=Total bacterial count

Ps=Total psychrophilic bacterial count

Spore1= mesophilic sporeformers bacterial count

Spore2= psychrophilic sporeformers bacterial count

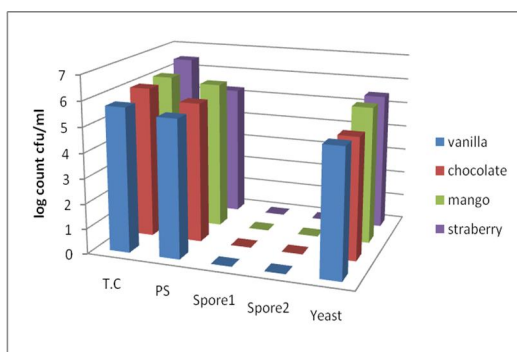

Fig (7). Microbiological examination of fresh wheat ice-cream

T.C=Total bacterial count

Ps=Total psychrophilic bacterial count

Spore1=mesophilic sporeformers bacterial count

Spore2= psychrophilic sporeformers bacterial count

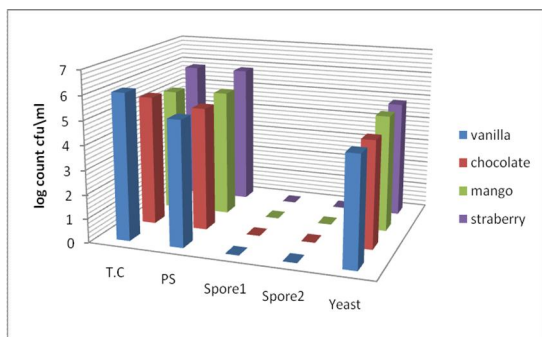

Fig (8). Microbiological examination of fresh milk ice-cream

T.C=Total bacterial count

Ps=Total psychrophilic bacterial count

Spore1=mesophilic sporeformers bacterial count

Spore2= psychrophilic sporeformers bacterial count

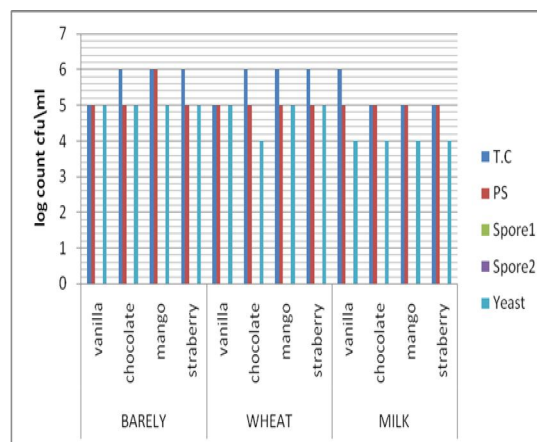

Fig(9). Microbiological examination of barley, wheat extract and milk ice-cream after three months of storage

T.C=Total bacterial count

Ps=Total psychrophilic bacterial count

Spore1=mesophilic sporeformers bacterial count

Spore2= psychrophilic sporeformers bacterial count

Results as shown in Fig (9) revealed that the microbiological examination of barley, wheat extract and milk ice-cream after three months of storage in freezer (-18 °C) were had no changes.

Sensory evaluation of ice-cream:

The results in Table (1) indicated that chocolate ice-cream with barley or strawberry showed higher quality attributes especially texture, color, taste, appearance and overall acceptability, compared with the ice cream with wheat or milk. In addition, the ice cream with wheat received the lower color, taste and overall acceptability than the ice -Cream with barley and milk. The ice cream with barley was highly accepted for appearance, texture, taste and odor, respectively.

Conclusion

It could be concluded that viable *Saccharomyces cerevisiae* cells possess aflatoxins binding ability which can be incorporated into some cereal based dairy products this gives a new hope for safety cereal-based ice-cream where high aflatoxins level is potential health risk.

Corresponding author

Eman M. Hegazy

Food Toxicology and contaminants Department
National Research Centre, Dokki, Cairo, Egypt

Table (1) Sensory evaluation of ice-cream supplemented with barley or wheat extracts, milk and viable *S. cerevisiae*.

Ice-cream	Textures (10)	Color (10)	Odor (10)	Taste (10)	Appearance (10)	Overall Acceptability (10)
Ice-cream supplemented with barley extract and <i>S. cerevisiae</i>						
Vanilla	7.3±1.83 ^{ab}	7.4±0.84 ^a	7.3±0.61 ^{ab}	6.1±0.82 ^{ab}	6.9±0.02 ^{ab}	6.2±1.55 ^b
Chocolate	8.3±1.42 ^a	7.8±2.04 ^a	8.5±0.30 ^a	8.1±0.06 ^a	7.7±0.21 ^a	8.2±1.32 ^a
Strawberry	8.1±1.63 ^a	7.4±2.22 ^a	8.3±0.45 ^a	7.6±0.09 ^a	7.8 ^a ±0.17	8.0±1.34 ^a
Mango	7.5±1.27 ^{ab}	7.2±1.84 ^a	7.2±0.53 ^{ab}	5.7±0.56 ^{abc}	6.6±0.38 ^{ab}	7.1±1.45 ^{ab}
Ice-cream supplemented with wheat extract and <i>S. cerevisiae</i>						
Vanilla	6.6±1.51 ^{abc}	7.6±1.71 ^a	6.9±0.72 ^{ab}	6.25±0.36 ^{ab}	6.6±0.02 ^{ab}	7.1±2.18 ^{ab}
Chocolate	6.9±2.02 ^{abc}	6.9±2.02 ^a	7.3±0.33 ^{ab}	6.5±0.11 ^{ab}	6.4±0.21 ^{ab}	7.0±2.26 ^{ab}
Strawberry	7.8±1.03 ^a	7.4±1.71 ^a	7.9±0.68 ^a	7.8±0.16 ^a	6.2±0.38 ^{ab}	7.6±1.96 ^{ab}
Mango	5.5±1.35 ^c	7.2±1.61 ^a	6.3±0.53 ^b	5.5±0.26 ^{abc}	6.8±0.17 ^{ab}	7.0±1.63 ^{ab}
Ice-cream with milk and <i>S. cerevisiae</i>						
Vanilla	7.6±1.96 ^a	7.2±1.03 ^a	7.0±0.61 ^{ab}	7.5±0.06 ^a	6.3±0.17 ^{ab}	7.4±1.35 ^{ab}
Chocolate	6.9±2.02 ^{abc}	7.1±1.69 ^a	6.5±0.30 ^b	5.5±0.26 ^{abc}	7.2±0.66 ^a	7.2±1.40 ^{ab}
Strawberry	7.2±1.27 ^{ab}	7.8±1.40 ^a	7.5±0.45 ^{ab}	5.7±0.56 ^{abc}	7.6±0.24 ^a	7.5±1.62 ^{ab}
Mango	7.15±1.63 ^{ab}	7.7±1.75 ^a	7.2±0.53 ^{ab}	6.1±0.82 ^{ab}	7.4±0.81 ^a	7.4±0.92 ^{ab}
LSD (0.05%)	1.59	NS	1.56	0.72	0.49	1.36

A, b: Mean in each row followed by the differ letter are significantly different $p \leq 0.05$

NS = Non significant

References:

- A.O.A.C. (2007). Association of Official Analytical Chemists, Official Methods of Analysis .20th Ed., published by the Association of Official Analytical Chemists International, Arlington, Virginia 22201. 3301, USA.
- Atanda, O.; Oguntubo, A.; Adejumo, O.; Ikeorah, J. and Akpan, I. (2007). Aflatoxin M₁ contamination of milk and ice-cream in Abeokuta and Odede local governments of Ogun State, Nigeria. *Chemosphere*, 68:1455-1458.
- Bejaoui, H.; Mathieu, F.; Taillandier, P. and Lebrihi, A. (2004). Ochratoxin A removal in synthetic and natural grape juices by selected oenological *saccharomyces* strains. *Journal of Applied Microbiological*, 97:1038-1044.
- Bueno, O.J.; Casale, C.H.; Pizzolitto, R.P.; Salvono, M.A. and Oliver, G. (2007). Physical adsorption of aflatoxin B₁ by lactic acid bacteria and *Saccharomyces cerevisiae*: a theoretical model. *J. Food Prot.* 70:2148-2154.
- Charalampopoulos, D.; Wang, R.; Pandiella, S.S. and Weble, C. (2002). Application of cereals and cereal components in functional foods: a review. *International Journal of Food Microbiological* 79: 131-141.
- Cleveland, T.E.; Dowd, P.F. and Desjardins, A.E. (2003). United States Department of Agriculture Agricultural Research Service, Research on pre-harvest prevention of mycotoxins and mycotoxigenic fungi in US crops. *Pest Manag. Sci.* 59: 629-642.
- De Vuyst, L. (2000). Technology aspects related to the application of functional starter cultures. *Food Technology and Biotechnology* 38: 105-112.
- Elli, M.; Zink, R.; Reniero, R. and Morelli, L. (1999). Growth requirements of *Lactobacillus johnsonii* in skim and UHT milk. *International Dairy, J.* 9:507-513.
- FDA (1992). Food and Drug Administration. Bacteriological analytical manual, 7th (Ed. Pub. By AOAC Intern., 2200 Wilson Boulevard., Suite 400, Arlington, VA 22201, USA.
- Guo, Y.; Breeden, L.L., Zarbl, H.; Preston, B.D. and Eaton, D.L. (2005). Expression of a human cytochrome P450 in yeast permits analysis of pathways for response to and repair of aflatoxin-induced DNA damage. *Mol Cell Biol.* 25: 5823-5833.
- Jespersen, L. (2003). Occurrence and taxonomic characteristics of strains of *Saccharomyces cerevisiae* predominant in African indigenous fermented foods and beverages. *FEMS yeast Res.* 3: 191-200.
- Meer, R.R.; Baker, J.; Bodyfett, F.W. and Griffiths, M.W. (1991). Psychrotrophic *Bacillus spp.* In fluid milk products: a review. *J. Food Protection*, 54:969-979.
- Meligaard, M.; Giville, G.V. and Carr, B.T. (1991). Sensory Evaluation Techniques. Sec. ed. CRC Press, Inc. Boca Raton, FL.

- Rao, M. and Blane, K. (1985). PC-STAT, statistical programs for microcomputers, Ver. IA. Food Science Department, University of Georgia, Athens, GA, USA.
- Richard-Molard, D. (1999). Mycotoxin occurrence, identification of fusarium species and role of processing. IRTAC conference, December 1-2, Paris France (Internal document: IRTAC, 16 Rue Nicolas Fortin, 75013 Paris).
- Santin, E.; Paulilo, A.C.; Maiorka, A.; Nakaghi, L.S.O.; Macan, M.; de Silva, A.V.F. and Alessi, C.A. (2003). Evaluation of the efficiency of *Saccharomyces cerevisiae* cell wall to ameliorate the toxic effects of aflatoxin in broiles. International Journal of Poultry Sciences 2: 241-344.
- Sarais, I.; Piussi, D.; Agwli, V. and Stecchini, M.L. (1996). The behavior of yeast population in stracchino cheese packaged under various conditions. J.Food Prol., 59:541-544.
- Sazawal, S; Hiremath, G.; Dhingra, U.; Malik, P.; Deb, S. and Black, R. (2006). Efficacy of probiotics in prevention of acute diarrhea: a meta-analysis of masked, ranomised, placebo-controlled trials. Lancet Infect. Dis. 6 374382.
- Shetty, P.H.; Hald, B. and Jespersen, L. (2007). Surface binding of aflatoxin B₁ by *Saccharomyces cerevisiae* strains with potential decontaminating abilities in indigenous fermented foods. International Journal of Food Microbiological, 113:41-46.
- Steyn, P.S. (1995). Mycotoxins, general view, chemistry and structure. Toxicol. Lett. 82: 843-851.
- Taillandier, P.; Gilis, F.; Portugal, F.R. Laforce, P. and Strehaiano, P. (1996). Influence of medium composition, PH and temperature on the growth and viability of *Lactobacillus acidophilus*. Biotech. Letters. 18: 775-780.
- Van der Aa Kiihle, A. and Jespersen, L. (2003). The taxonomic position of *Saccharomyces boulardii* as evaluated by sequence analysis of the D1/D2 domain of 265s rDNA, the ITS1-5.8s rDNA-ITS2 region and the mitochondrial cytochrome. C oxidase II gene. Syst. Appl. Microbial. 26: 564-571.

10/2/2011

Response of MC3T3-E1 Cell Line to the RF Exposure at 2.4GHz

¹Hsien-Chiao Teng, ²Shen Cherng

¹Department of Electrical Engineering, ROC Military Academy, Fengshan, Kaohsiung, Taiwan 830, Republic of China

²Department of Computer Science and Information Engineering, Chengshiu University, Niasong, Kaohsiung, Taiwan 833, Republic of China

cherngmsu@gmail.com

Abstract: The response analysis of MC3T3-E1 cell line to the radio frequency (RF) at 2.4GHz can be recognized by the observation of gap junctional intracellular communication (GJIC) modulation. Meanwhile, fuzzifier of the local affected near magnetic field fluctuations at specific time range in a special fuzzy inference engine that we developed to contrast with the experimental results of GJIC assay is found to be reasonably agreed. The measurement of local near magnetic field fluctuation can therefore be related to the GJIC so that to express the biological effect of the response of MC3T3-E1 cell line to the RF exposure at 2.4GHz.

[Hsien-Chiao Teng, Shen Cherng. **Response of MC3T3-E1 Cell Line to the RF Exposure at 2.4GHz.** Life Science Journal. 2011;8(4):82-85] (ISSN:1097-8135). <http://www.lifesciencesite.com>.

Key words: Gap Junctional Intracellular Communication (GJIC); Fuzzy Inference Engine, Cell Line

1. Introduction

The osteoblastic cell line MC3T3-E1 is established from a C57BL/6 mouse calvaria and selected on the basis of high alkaline phosphatase (ALP) activity in the resting state. Cells basically can differentiate into osteoblasts and osteocytes and have been demonstrated to form calcified bone tissue in vitro [1]. There have been of considerable discussion concerning the response of the cell line responding to the RF exposure [2,3]. No clinical evidence has shown any human health effect and no mechanism can clearly explain every observed biological effect [3]. This report only describes our study of the Osteoblast cellular response to the reaction of external RF exposure at 2.4GHz.

Gap junctional intracellular communication (GJIC) within the cells can induce the physical signals from varying surface current [4,5] on the cells. In a cell, six connexin 43 subunits oligomerize in the Golgi apparatus into a connexon, called hemi channel and be transported to plasma membrane of the cell. Before pairing process, hemi channels are closed to avoid leakage of cellular contents and entry of extra-cellular materials. During the pairing of connexons and aggregation into plaques at the plasma membrane, connexin 43 is phosphorylated at least twice and connexons are attracted to those located on the adjacent cells. Two connexons join in an end-to-end manner to form a complete channel. The channel aggregate into large gap junction plaques open to connect two cells for cell-to-cell communication and is called gap junctional intracellular communication (GJIC), which can be modulated by environmental factors, such as low power RF signals.

From theoretical point of view, four different

types of interference in environment may obstruct the cellular responded signals being detected. Those types of interference include degrading of the signals, increasing signal bandwidth, coupling of signal to the noise and signal overlapping. Basically, most of the cellular responding signals to the RF exposure should be deterministic signal which is the one whose values in the future can be predicted if enough information about its past is known. However, the stochastic cellular signal can also be one of the possibilities created by the cell lines in vitro under the exposure of RF. Other possibilities include cellular fractal signal that have the property being referred as scale-invariance and chaotic signal to be as deterministic signal with sensitive dependence on some conditions that cannot be predicted exactly in the future [6].

Since the function of the GJIC, cultured cells coupled together in vitro except the stem cells and cancer cells, we can observe the GJIC modulation from the diffusion of the fluorescence (dye). In this article, we will present a novel method to recognize the non-stationary near magnetic field fluctuation caused by the cellular response of the reaction to the RF exposure. The near magnetic field fluctuations created by the induced GJIC surface current of the osteoblast cell system can be analyzed by fuzzy inference engine to connect the GJIC modulation to identify if the cellular response is existed. The varied diffuse range of Lucifer yellow fluorescence expresses the cellular response under the exposure of RF at 2.4GHz may be affiliated with many pathological endpoints [7].

2. Materials and Methods

Data Acquisition

A sensitive probe of Gauss-meter, attached to the cells in the culture dish was used to measure the cell induced near magnetic field fluctuations. The Gauss-meter was manufactured by F.W. Bell Company (series of 9550) in Florida. The design and set up is shown in Figure 1. The measured near field fluctuation was transformed to electrical voltages shown to the oscilloscope. The oscilloscope was manufactured by Agilent Company (54621A). By using HP Benchlink, we were able to collect the data from the oscilloscope and transform to Microsoft Excel as text files. By placing only medium in culture dish without cell cultured, medium induced fluctuation was also measured. In contrast, control group was the local geomagnetic fluctuation measured. Matlab and Fortran computer languages were used for data analysis.

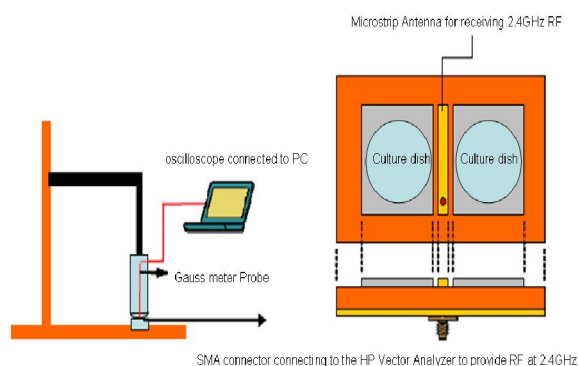

Figure 1. Set up the measurements of near magnetic field fluctuation

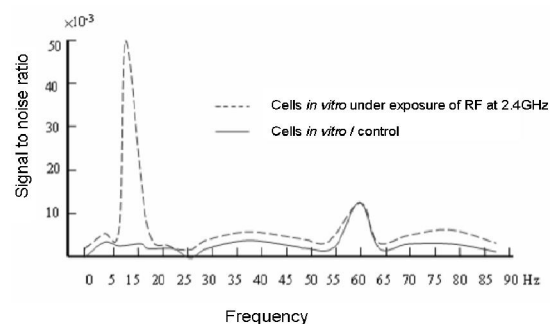

Figure 2. The signal ratio of the responding signal that may caused by MC3T3-E1 cells exposed upon RF at 2.4GHz

SNR Analysis

By using RS232, transferred the probe

measured data from gauss-meter to the oscilloscope, the output oscilloscopic voltage was restored to Microsoft Excel as text files at the recording rate of 2000 times in a second. We can calculate the autocorrelation and perform Fourier transform to compute the corresponding Power Density Spectrum (PDS) to determine the power of signal, power of noise, and complete the corresponding SNR in data through the formula, $SNR = \frac{\text{Signal Power}}{\text{Noise Power}}$ (signal to noise ratio) at different frequencies. Upon different order polynomials for curve fitting in contrast to linear, we are able to determine the relationship between the corresponding intrinsic frequency vs. the noise of the signal in data. If the intrinsic ELF signal was not at the frequency of the test signal in the data file, SNR should be zero or negative when SNR is zero. Performing the same procedures, as controls, we computed the SNR at a specific frequency and depicted in Figure 2. It can be accurate to the order of 10^{-6} .

Fuzzy Analysis

Based upon the measurements of near magnetic field fluctuation, we adjusted the distribution of the fluctuations as eight different discrete values. Using If-Then type fuzzy rules converts the fuzzy input to the fuzzy output. Fuzzifier the input (measurement), we make its output values to be only three possibilities. The first possibility is that the cell is responded to the microwave. The second one is that cell did not respond to the microwave. The third one is that the cells response can not be determined either being responded or not. Fuzzy membership functions and the rules are defined. We used of Matlab toolbox as the base to establish an inference engine with three output by using of different membership functions (trapmf) to create 9 rules to performance the antecedents and consequences.

Cell Culture

The osteoblast cell line in vitro was obtained from D.T. Yamaguchi, Research Service and Geriatrics Research, Education, and Clinical Center, VAMC, West Los Angeles, California, USA It was maintained in D-medium (Formula 78-5470EF, GIBCO, Grand Island, NY, USA), supplemented with 10% fetal bovine serum (GIBCO) and 50 $\mu\text{g}/\text{ml}$ gentamicin (Quality Biological, Inc., Gaithersburg MD, USA). The cells were incubated at 37°C in a humidified atmosphere containing 5% CO_2 and 95% air and were fed or trypsinized every two to three days.

Bioassay of GJIC

The scrape load/dye transfer (SL/DT) technique

was used to measure the GJIC within cells. After exposure to ELF at intrinsic frequency, the cells were rinsed with phosphate buffered saline (PBS), and a PBS solution containing 4% concentration Lucifer yellow fluorescence dye is injected into the cells by a scrape using a scalpel blade. Afterwards the cells were incubated for 3 min and extra cellular dye was rinsed off and fixed with 5% formalin. We then measured the area of the dye migrated from the scrape line using digital images taken by an epifluorescent microscope and quantitated with Nucleotech image analysis software [5] for the GJIC images. Since GJIC is affiliated with many pathological endpoints, we use GJIC as a scale factor to evaluate the ELF reaction for cell system. Scrape loading dye transfer of Lucifer yellow is used to measure gap junction intracellular communication (GJIC) modulation under the exposure of RF at 2.4GHz [8]. The intrinsic resonance detected in SNR spectrum of the mouse osteoblast cells system is very likely to be a chaotic signal, which is not fully predictable.

3. Results

Figure 3 and Figure 4 depicted the comparisons of the output distribution of the possibilities through fuzzy inference engine and the GJIC. The GJIC of cells was quantified with the measurement of the average distance of dye migration.

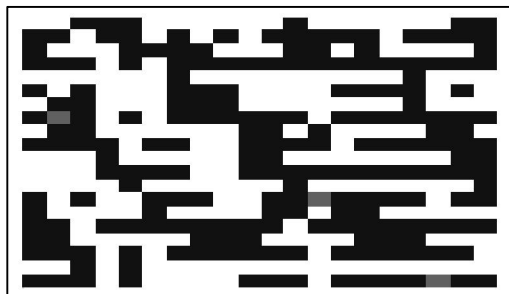

(a)

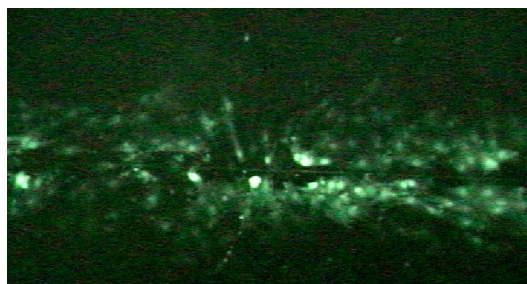

(b)

Figure 3. (a) output distribution of the possibilities through fuzzy inference engine (b) GJIC dye diffusion for the cells *in vitro* exposed RF at 2.4GHz



(a)

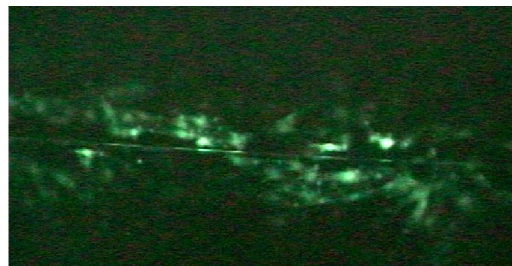

(b)

Figure 4. (a) output distribution of the possibilities through fuzzy inference engine (b) GJIC dye diffusion for the cells *in vitro* without RF exposure

In Figure 3 (a), three grey levels are shown, deep-black, light gray and white. In our Fuzzy Inference Engine Design, white level means nothing happen of the cell exposed to the RF at 2.4GHz and deep-black means that it is not for sure if the cell is responded to the RF exposure. The light-gray means the cell is responded to the RF at 2.4GHz. In Figure 4 (a), the experimental result has shown that there is no light-grey can be found in control and the RF exposure increased the numbers of deep-black in Figure 3(a). Meanwhile, we can see clearly the different diffusion of the dye for GJICs from Figure 3(b) and Figure 4(b) that was observed as the evidence for the cell reaction of the RF at 2.4GHz

4. Discussion

Experimental result relates the near magnetic field fluctuation to the GJIC within cells. A strong signal to noise ratio at 14Hz is depicted in Figure 2. It may present that the 14Hz is the responding frequency of the cell to the exposure of RF at 2.4GHz [9]. Graphically, it has shown a frequency band at 14 Hz in the time interval between 0.05 seconds to 0.5 seconds. However, since 14Hz is in the lower frequency band, the time range may need to be relocated. Fortunately, GJIC assay can support the result of the existence of the intrinsic frequency.

5. Conclusion

The main feature of our research is that the cellular response may relate to the change of GJIC.

Additionally, the near magnetic fluctuation expression for cell induced GJIC can be identified at the same time by going through fuzzy inference engine and observing GJIC modulation at 20% in variance.

Biological Effect of MC3T3-E1 in vitro by A Novel 2.4GHz Radiofrequency Electromagnetic Field Exposure System. Life Science Journal 6(4): 42-50, 2009.

Acknowledgement

This study is under the grant of NSC-100-2221-E-230-010 Taiwan, National Science Council.

11/22/2011

Correspondence to:

Shen Cherng, PE, MD, PhD
Department of Computer Science and Information Engineering
Chengshiu University, Niasong, Kaohsiung, Taiwan
833 ROC
Email: cherngs@csc.edu.tw
Telephone: 011886-7731-0606 ext 3719

References

- [1] Nobuyuki Udagawa, Naoyuki Takahashi, Takuhiko Akatsu, Takahisa Sasaki, Akira Yamaguchi, Hiroaki Kodama, T. John Martin And Tatsuo Suda: The Bone Marrow-Derived Stromal Cell Lines MC3T3-G2/PA6 and ST2 Support Osteoclast-Like Cell Differentiation in Cocultures with Mouse Spleen Cells, *Endocrinology* 125 (4): 1805, 1989.
- [2] Larjavaara S, Schüz J, Swerdlow A, Feychting M, Johansen C, Lagorio S, et al. Location of gliomas in relation to mobile phone use: a case-case and case-specular analysis. *Am. J. Epidemiol.* 174:2-11, 2011.
- [3] Editors: Paolo Vecchia, Rüdiger Matthes, Gunde Ziegelberger, James Lin, Richard Saunders, Anthony Swerdlow (2009) Exposure to high frequency electromagnetic fields, biological effects and health consequences (100 kHz-300 GHz) ICNIRP 16/2009
- [4] Hart F. Cell culture dosimetry for low frequency magnetic fields. *Bioelectromagnetics* 17:48-57, 1996.
- [5] Trosko JE, Chang CC. Role of stem cells and gap junctional intercellular communication in human carcinogenesis. *Radiation Research* 155:175-80, 2001;
- [6] Bruce EN. Biomedical signal processing and signal modeling. NEW YORK: JOHN WILEY & SONS 2001.
- [7] Upham BL, Deocampo ND, Wurl B, Trosko JE. Inhibition of gap junctional intracellular communication by perfluorinated fatty acids is dependent on the chain length of the fluorinated tail. *Int J Cancer* 78:491-5, 1998;
- [8] Cherng, S., Teng, HC. (2009): Study of

Antihyperglycemic and Antihyperlipidemic Effects of Hesperidin and Naringin in High Fat Diet/Streptozotocin Type 2 Diabetic Rats

Osama Mohamed Ahmed; Ayman Moawad Mahmoud*; Adel Abdel-Moneim
and Mohamed B. Ashour

Physiology Unit, Zoology Department, Faculty of Science, Beni-Suef University, Beni-Suef, Egypt.

*aymano911@yahoo.com

Abstract: The purpose of this study was to investigate the effect of hesperidin and naringin on blood glucose, glycosylated hemoglobin and serum insulin levels in high fat fed/streptozotocin-induced type 2 diabetic rats. Also this study evaluated effects of the tested compounds on lipid profile, serum adiponectin and resistin levels, serum cardiac function parameters and liver and muscle glycogen contents. An oral dose of 50 mg/kg b.wt. hesperidin or naringin was given continually for 30 days after diabetes induction. In the diabetic control group, levels of glucose, glycosylated hemoglobin, AST, LDH and CK-MB were significantly increased, while serum insulin level and hepatic and muscle glycogen were decreased. Both hesperidin and naringin supplementation significantly reversed these parameters. In addition, both compounds were found to alleviate lipid profile and serum adiponectin and resistin levels. These results showed that hesperidin and naringin have potential antihyperglycemic and antidiabetic activities in high fat fed/STZ-induced type 2 diabetic rats.

[Osama Mohamed Ahmed; Ayman Moawad Mahmoud; Adel Abdel-Moneim and Mohamed B. Ashour **Antihyperglycemic and Antihyperlipidemic Effects of Hesperidin and Naringin in High Fat Diet/Streptozotocin Type 2 Diabetic Rats**] Life Science Journal. 2011; 8(4):91-101] (ISSN: 1097-8135). <http://www.lifesciencesite.com>.

Key words: Hesperidin, naringin, insulin resistance, adiponectin, resistin.

1. Introduction

Diabetes mellitus, a pervasive and multifactorial metabolic syndrome, is characterized by imperfection in insulin secretion and insulin receptor or postreceptor events with derangement in carbohydrate, protein and lipid metabolism and results in chronic hyperglycemia, a clinical hallmark of diabetes (1). Hyperglycemia and hyperlipidemia, as the most common features of diabetes mellitus, contribute to the development of microvascular and macrovascular complications of diabetes, which cause the morbidity and mortality of diabetes (2). In addition, hyperglycemia in diabetic patients is associated with alteration in glucose and lipid metabolism and modification in liver enzyme levels (3). Diabetes mellitus is recognized as a major risk factor for cardiovascular diseases (CVD) such as atherosclerosis, heart attack, stroke etc. About 75% of deaths among men with diabetes and 57% among women with diabetes are attributable to CVD (4).

Adiponectin is a peptide hormone predominantly synthesized and secreted from adipose tissue that modulates a number of metabolic processes, including glucose regulation, fatty acid catabolism, and vascular biology (5,6). In contrast to other adipokines, adiponectin is underexpressed in obese patients with insulin resistance or type 2 diabetes mellitus (T2DM) (7,8), and in patients with coronary heart disease (8). In human subjects, circulating levels of adiponectin are positively

correlated with insulin sensitivity (9). Low plasma levels of adiponectin (hypoadiponectinemia) have been observed in several forms of diabetes with insulin resistance, including T2DM, gestational diabetes, and diabetes associated with lipodystrophy (9). Resistin belongs to a family of cysteine-rich secretory proteins called resistin-like molecules (10,11). In rodents, resistin is derived almost exclusively from adipose tissue, and serum resistin is elevated in animal models of obesity and insulin resistance (12,13). Plasma resistin levels were highly positively correlated with TG and apoA-I/apoB ratio, whereas they were inversely correlated with high density lipoprotein (HDL) and apoA-I levels (14). Moreover, the insulin-resistant effects of resistin are thought to account for the activation of glucose 6-phosphatase, which subsequently prevents glycogen synthesis and increases the rate of glucose production (15). These findings suggest that resistin contributes to the development of insulin resistance and atherosclerosis, and thereby is linked to clinical vascular events (16,17).

Nowadays the agents used as the main means for diabetes treatment are synthetic drugs and insulin. However, these drugs usually come with considerable side effects, such as hypoglycemia, drug-resistance, dropsy, and weight gain (18). In contrast, hundreds of traditional folk medicines have demonstrated potential for the treatment of diabetes with less tolerability and side effects. Thus, there is an

increasing need to search for more natural antidiabetic agents from the traditional medicine. Currently, there is much interest in the usefulness of citrus fruits because of their intake appears to be associated with reduced risk of certain chronic diseases and increased survival as reported by **Chen et al.** (19). Thus, the present study was designed to evaluate the efficacy of the citrus flavonoids, hesperidin and naringin, on the impaired glucose tolerance, insulin resistance and some biochemical parameters of high-fat diet/streptozotocin induced-diabetic albino rats and to suggest their probable hypoglycemic and hypolipidemic mechanisms of action.

2. Material and Methods:

Chemicals

Hesperidin, naringin and streptozotocin, were purchased from Sigma Chemicals Co., St. Louis, MO, USA, stored at 2-4 °C and protected from sunlight. All other chemicals were of analytical grade and were obtained from standard commercial supplies.

Experimental animals

White male albino rats (*Rattus norvegicus*) weighting about 190±10 g were used as experimental animals in the present investigation. The animals were housed in standard polypropylene cages and maintained under controlled room temperature (22±2 °C) and humidity (55±5%) with 12 h light and 12 h dark cycle and were fed a standard diet of known composition, and water *ad libitum*. The animals used in the present study were maintained in accordance with the principles and guidelines of the Canadian Council on Animal Care as outlined in "Guide for the Care and Use of Laboratory Animals" (20).

Development of HFD-fed low dose STZ-treated type 2 diabetic rats

The rats were allocated into two dietary regimens by feeding either normal or high fat diet (HFD) *ad libitum*, for the initial period of 2 weeks (21). The composition and preparation of HFD were described elsewhere (22). After the 2 weeks of dietary manipulation, the group of rats fed by HFD were injected intraperitoneally (i.p.) with low dose of STZ (35 mg/kg b.wt.), while the respective control rats were given vehicle citrate buffer (pH 4.5) in a dose volume of 1 ml/kg, i.p. Seven days after STZ injection, rats were screened for blood glucose levels. Overnight fasted (10-12 hours) animals were given glucose (3 g/kg b.wt.) by gastric intubation. After 2 hours of oral administration, blood samples were taken from lateral tail vein, left to coagulate and centrifuged then serum glucose concentration was

measured. Rats having serum glucose ≥ 300 mg/dl, after 2 hours of glucose intake, were considered diabetic and selected for further pharmacological studies. The rats were allowed to continue to feed on their respective diets until the end of the study.

Experimental design

The experimental animals were divided into four groups, each group comprising six rats as detailed follows. Group 1 served as control rats; Group 2 served as diabetic control rats; Group 3 served as diabetic rats administered with hesperidin (50 mg/kg b.wt.) in aqueous suspension orally for 30 days, and Group 4 served as diabetic rats administered with naringin (50 mg/kg b.wt.) in aqueous suspension orally for 30 days. The dosage was adjusted every week according to any change in body weight to maintain similar dose per kg body weight of rat over the entire period of study for each group. By the end of the experiment, animals were sacrificed and blood samples, muscle and liver were obtained.

Biochemical study

On the day before sacrifice, oral glucose tolerance test (OGTT) was performed in normal, diabetic control and diabetic rats treated with hesperidin and naringin. Blood samples were obtained from lateral tail vein of rats deprived of food overnight (10-12 hours). Successive blood samples were then taken at 0, 30, 60, 90 and 120 minutes following the administration of glucose solution (3 g/kg b.w.) through gastric intubation. Blood samples were left to coagulate, centrifuged, and clear non-hemolyzed serum was obtained for determination of glucose concentration according to the method of Trinder (23), using commercial diagnostic kit (Randox laboratories, UK). Serum insulin level was assayed by Sandwich ELISA using kits purchased from Linco Research, USA. Blood glycated Hb was determined according to the method of Little *et al.* (24) using Helena GLYCO-Tek affinity column method (Helena Laboratories, USA). Liver and muscle glycogen contents were assayed according to the method of Seifter *et al.* (25). Serum adiponectin was assayed by Sandwich ELISA using kits of purchased from Linco Research (USA) and serum resistin was assayed using ELISA kits purchased from Biovendor (USA).

Because abnormalities in insulin action are poorly detected by a single determination of glucose or insulin levels (26,27), the insulin resistance was evaluated by homeostasis model assessment estimate of insulin resistance (28) as follows:

$$\text{HOMA-IR} = \text{Fasting insulin level } (\mu\text{U/ml}) \times \text{Fasting blood glucose } (\text{mmol/l}) / 22.5.$$

Serum cholesterol (29), triglycerides (30), HDL-cholesterol (29), free fatty acids (31), and liver hydroxymethylglutaryl-CoA reductase activity (32) were estimated. Serum LDL-cholesterol level was calculated from Friedewald (33) formula (LDL-cholesterol = total cholesterol – triglycerides/5 – HDL-cholesterol). Serum vLDL-cholesterol concentration was calculated according to Nobert (34) formula (vLDL-cholesterol = triglycerides/5). Serum aspartate aminotransferase (AST) (35), lactate dehydrogenase (LDH) (36), and Creatine kinase (CK-MB) (37) activities were also estimated. Cardiovascular indices were calculated according to Ross formula (38) as the following: Cardiovascular index 1 = total cholesterol/HDL-cholesterol and Cardiovascular index 2= LDL-cholesterol/HDL-cholesterol.

Statistical analysis

The data were analyzed using the one-way analysis of variance (ANOVA) (39) (PC-STAT, University of Georgia, 1985) followed by LSD test to compare various groups with each others. Results were expressed as mean \pm SE and values of $P > 0.05$ were considered non-significantly different, while those of $P < 0.05$ and $P < 0.01$ were considered significant and highly significant, respectively.

Results

The OGTT of diabetic rats showed a highly significant elevation at fasting state and at 30, 60, 90 and 120 min after oral glucose loading as compared to normal animals. The treatment of diabetic animals with hesperidin and naringin induced a potential improvement of elevated values at all points of OGTT curve (Fig. 1).

Table 1 shows the effect of hesperidin and naringin on the levels of fasting serum insulin and blood glycosylated hemoglobin (HbA1c%) in the control and experimental groups of rats. Diabetic group of rats have highly significantly ($p < 0.01$; LSD) elevated HbA1c% as compared with normal control group of rats. Oral administration of hesperidin as well as naringin to diabetic rats significantly ($p < 0.01$; LSD) improved the altered level. Serum insulin level exhibited an opposite pattern; it was significantly ($p < 0.01$; LSD) decreased in diabetic rats as compared to normal ones and was significantly increased as a result of treatment with both hesperidin and naringin. Liver and muscle glycogen contents of HFD/STZ diabetic control rats showed a highly significant decrease (LSD; $P < 0.01$) as compared to normal control. Both treatment agents showed a detectable amelioration of liver and muscle glycogen contents of diabetic rats (Table 1).

HOMA-IR of normal, diabetic and diabetic treated with hesperidin and naringin is depicted in figure 2. Diabetic rats showed a significant ($p < 0.01$; LSD) elevation of HOMA-IR that was decreased significantly upon administration of either hesperidin or naringin. However, while both hesperidin and naringin have more or less similar effects, hesperidin seemed to be more effective on serum insulin, blood HbA1c% and HOMA-IR.

Data on the effect of hesperidin and naringin on lipid profile of diabetic rats are presented in Table 2. Diabetic rats exhibited a highly significant increase ($P < 0.01$; LSD) in serum cholesterol, triglycerides, LDL- and vLDL-cholesterol and FFAs as compared with the non-diabetic group. Moreover, HDL-cholesterol was affected in an opposite manner, as it was decreased ($P < 0.01$; LSD) in diabetic rats and significantly increased ($P < 0.01$; LSD) in response to both treatment agents. The administration of both hesperidin and naringin led to marked amelioration of all parameters of the altered lipid profile. Liver HMG-CoA reductase activity, expressed as a ratio of HMG-CoA to mevalonate, was significantly (LSD; $P < 0.01$) increased in diabetic rats as compared with the normal control rats. Administration of the two tested agents produced a highly significant (LSD; $P < 0.01$) decrease in the enzyme activity as compared with the diabetic group as illustrated in figure 3.

Table 3 depicts the effect of hesperidin and naringin administration on some cardiac function biomarkers in serum of diabetic rats. Serum CK-MB, AST and LDH activities were deleteriously increased (LSD; $P < 0.01$) in the diabetic control rats. Moreover, treatment of diabetic animals with both hesperidin and naringin induced a potential alleviation (LSD; $P < 0.01$) of these altered parameters; hesperidin seemed to be more effective than naringin in improving serum AST and LDH activities, while the latter showed more potent effect on CK-MB activity. Cardiovascular risk indices 1 and 2 exhibited the same behavioral pattern; they were highly significantly (LSD; $P < 0.01$) increased in HFD/STZ diabetic rats as compared to normal control group. Hesperidin as well as naringin produced remarkable amelioration on these altered parameters (Fig. 4).

Diabetic rats exhibited a highly significant (LSD; $P < 0.01$) decrease in fasting serum adiponectin level as compared with the normal control rats. The administration of both agents showed a marked improvement (LSD; $P < 0.01$) of serum adiponectin concentration (Fig. 5). Administration of HFD and STZ produced a highly significant elevation ($P < 0.01$; LSD) of serum resistin as compared with normal rats. The treatment of HFD/STZ diabetic rats with hesperidin and naringin induced a highly significant

amelioration ($P < 0.01$; LSD) of the elevated serum resistin (Fig. 6).

4. Discussion

Type 2 diabetes develops primarily due to insulin resistance and insulin producing pancreatic β -cell dysfunction, leading to insufficient insulin secretion (40-42). The rats fed HFD can result in insulin-resistance mainly through Randle or glucose-fatty acid cycle (43,44). In our study, HFD/STZ diabetic control rats exhibited significantly elevated fasting blood glucose and HOMA-IR, accompanied with diminished serum insulin levels. Hence, it is suggested that insulin resistance has been developed in these animals. Therefore, this rat model exhibits hyperglycemia and insulin resistance that would closely reflect the natural history and metabolic characteristics of humans, and it is further sensitive to pharmacological testing.

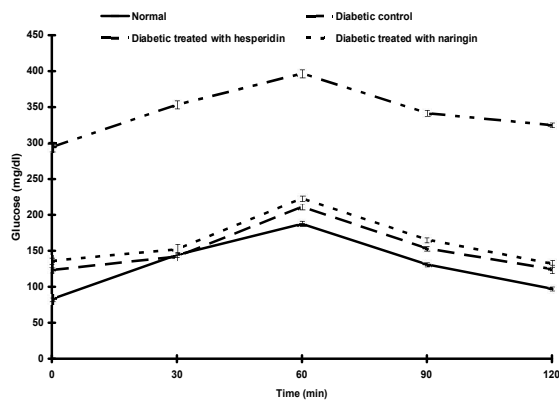

Fig. 1: OGTT of normal, diabetic control and diabetic rats treated with hesperidin and naringin.

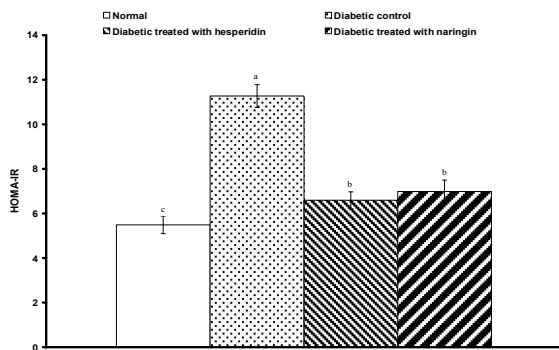

Fig. 2: HOMA-IR index of normal, diabetic control and diabetic rats treated with hesperidin and naringin.

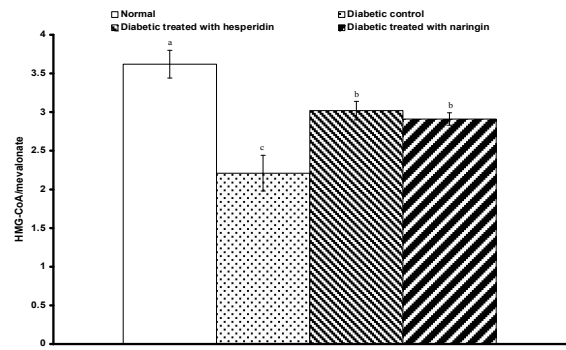

Fig. 3: Liver hydroxymethylglutaryl-CoA reductase activity of normal, diabetic control and diabetic rats treated with hesperidin and naringin.

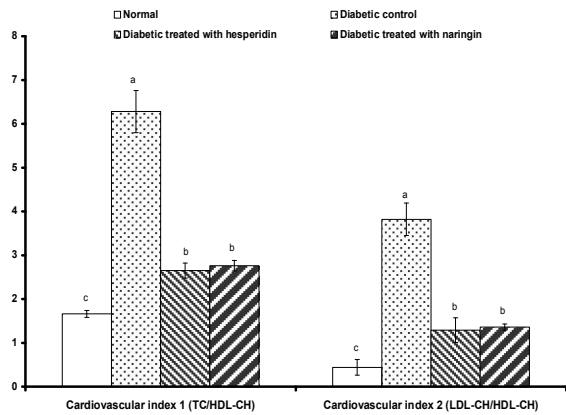

Fig. 4: Cardiovascular risk indices 1 and 2 of normal, diabetic control and diabetic rats treated with hesperidin and naringin.

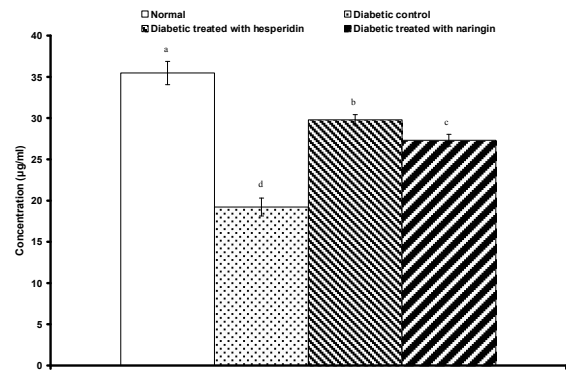

Fig. 5: Serum adiponectin of normal, diabetic control and diabetic rats treated with hesperidin and naringin.

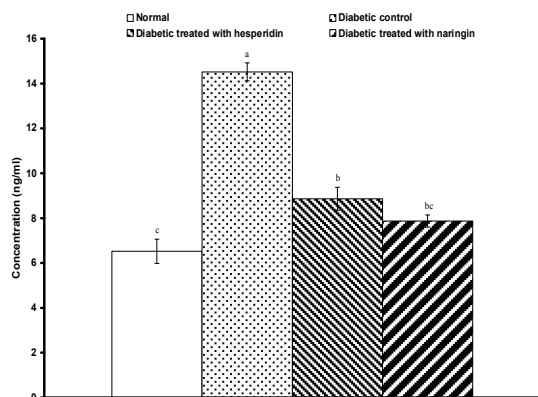

Fig. 6: Serum resistin of normal, diabetic control and diabetic rats treated with hesperidin and naringin.

Table 1: Serum insulin, blood glycosylated hemoglobin (HbA1c %), and liver and muscle glycogen content of normal, diabetic control and diabetic rats treated with hesperidin and naringin.

Group	Parameter	Insulin (μ U/ml)	HbA1c%	Liver glycogen (mg/g tissue)	Muscle glycogen (mg/g tissue)
Normal		26.84 \pm 1.40 ^a	4.71 \pm 0.18 ^d	22.81 \pm 1.86 ^a	4.98 \pm 0.22 ^a
Diabetic control		15.50 \pm 0.76 ^c	8.96 \pm 0.23 ^a	11.95 \pm 0.77 ^c	2.03 \pm 0.22 ^c
Diabetic treated with hesperidin		21.55 \pm 1.13 ^b	5.85 \pm 0.18 ^c	19.33 \pm 1.25 ^b	3.49 \pm 0.18 ^b
Diabetic treated with naringin		20.67 \pm 1.08 ^b	6.26 \pm 0.17 ^b	17.38 \pm 1.14 ^b	3.49 \pm 0.36 ^b
F- prob		P < 0.001	P < 0.001	P < 0.001	P < 0.001
LSD at 5%		2.32	0.40	2.74	0.53
LSD at 1%		3.17	0.54	3.73	0.72

- Data are expressed as Mean \pm SE. Number of animals in each group is six.

- Means which share the same superscript symbol (s) are not significantly different.

Table 2: Lipid profile of normal, diabetic control and diabetic rats treated with hesperidin and naringin.

Group	Parameter	Total Cholesterol (mg/dl)	Triglycerides (mg/dl)	HDL-cholesterol (mg/dl)	LDL-cholesterol (mg/dl)	vLDL-cholesterol (mg/dl)	Free fatty acids (mmol/L)
Normal		67.92 \pm 3.35 ^c	56.84 \pm 2.51 ^c	39.18 \pm 1.37 ^a	17.38 \pm 1.77 ^c	11.03 \pm 0.80 ^c	0.57 \pm 0.07 ^c
Diabetic control		199.90 \pm 5.05 ^a	193.17 \pm 3.28 ^a	26.87 \pm 1.71 ^c	101.19 \pm 5.43 ^a	38.50 \pm 1.79 ^a	1.68 \pm 0.06 ^a
Diabetic treated with hesperidin		93.10 \pm 2.38 ^b	82.68 \pm 2.58 ^b	33.19 \pm 1.65 ^b	42.77 \pm 1.71 ^b	15.97 \pm 1.22 ^b	0.92 \pm 0.10 ^b
Diabetic treated with naringin		98.34 \pm 3.77 ^b	85.71 \pm 2.96 ^b	33.77 \pm 1.53 ^b	46.16 \pm 3.14 ^b	16.24 \pm 1.72 ^b	1.04 \pm 0.12 ^b
F- prob		P < 0.001	P < 0.001	P < 0.001	P < 0.001	P < 0.001	P < 0.001
LSD at 5%		7.84	5.93	3.27	7.02	3.00	0.18
LSD at 1%		10.69	8.09	4.46	9.57	4.09	0.25

- Data are expressed as Mean \pm SE. Number of animals in each group is six.

- Means which share the same superscript symbol (s) are not significantly different.

Table 3: Heart function variables of normal, diabetic control and diabetic rats treated with hesperidin and naringin.

Group	Parameter	AST (U/L)	LDH (U/L)	CK-MB (U/L)
Normal		33.62 \pm 1.49 ^c	171.86 \pm 5.71 ^d	111.74 \pm 4.52 ^d
Diabetic control		95.03 \pm 5.24 ^a	276.74 \pm 7.96 ^a	262.24 \pm 5.24 ^a
Diabetic treated with hesperidin		45.07 \pm 1.60 ^b	196.05 \pm 3.84 ^c	180.65 \pm 5.08 ^b
Diabetic treated with naringin		46.79 \pm 2.20 ^b	210.66 \pm 6.43 ^b	168.63 \pm 4.45 ^c
F- prob		P < 0.001	P < 0.001	P < 0.001
LSD at 5%		6.35	13.52	10.25
LSD at 1%		8.66	18.44	13.98

- Data are expressed as Mean \pm SE. Number of animals in each group is six.

- Means which share the same superscript symbol (s) are not significantly different

In the diabetic animals, the present data indicate a marked increase in serum glucose levels as compared to normal rats. These results run parallel with the studies of Schalaan *et al.* (45) and Ahmed *et al.* (46). Administration of STZ caused rapid destruction of pancreatic β -cells in rats, which led to impaired glucose stimulated insulin release and insulin resistance, both of which are marked features of T2DM (47). Elevation of blood glucose may be attributed to reduced entry of glucose to peripheral tissues, muscle and adipose tissue (48), increased glycogen breakdown (49) and increased gluconeogenesis and hepatic glucose production (50). Furthermore, Powers (51) stated that insulin resistance in T2DM causes elevation in blood glucose due to the same reasons. From another point of view, the hyperglycemia observed in our study could be explained through glucose–fatty acid cycle (52), where the high FFAs reduce the glucose uptake and utilization, through the increased endogenous glucose production (53). The present data demonstrated that the treatment of diabetic rats with either hesperidin or naringin caused a potential amelioration of glucose tolerance. Decrease in the elevated serum glucose levels is in agreement with the results of Jung *et al.* (54) who recorded the hypoglycemic effect of hesperidin and naringin in C57BL/KsJ-db/db mice. Moreover, Pari and Suman (55) reported the hypoglycemic effect of naringin in STZ/nicotinamide diabetic rats and Akiyama *et al.* (56) showed the glucose lowering effect of hesperidin in type 1 diabetic rats.

The observed increase in the levels of glycosylated hemoglobin in diabetic control group rats is due to the presence of excessive amounts of blood glucose. During diabetes the excess of glucose present in blood reacts with hemoglobin to form glycosylated hemoglobin (57). Estimation of HbA1c has been found to be particularly useful in monitoring the effectiveness of therapy in diabetes (58). In our study, oral administration of hesperidin and naringin significantly decreased the levels of fasting blood glucose and HbA1c. These results indicated the beneficial effects of both hesperidin and naringin in preventing the pathogenesis of diabetic complications caused by impaired glucose metabolism.

In comparison with the normal control rats, the present study revealed a highly significant decrease in fasting insulin level of HFD/STZ diabetic rats. We hypothesize that the possible mechanism of hesperidin and naringin on hypoglycemic action may be through potentiating pancreatic secretion of insulin from β -cell of islets and/or due to enhanced transport of blood glucose to the peripheral tissue or by other mechanisms such as stimulation of glucose uptake by

peripheral tissue, inhibition of endogenous glucose production or activation of gluconeogenesis in liver and muscles. By their ability to scavenge free radicals hesperidin (59) and naringin (60) prevent STZ-induced oxidative stress and protects β -cells resulting in increased insulin secretion and decrease in the elevated blood glucose levels. In this context, research by Pari and Suman (55), have shown that, naringin decreased the elevated blood glucose concentration and increased the insulin release in STZ-induced diabetic rats. Also, Akiyama *et al.* (56) reported that, in STZ-induced diabetic rats, hesperidin decreased blood glucose and increased serum insulin levels.

Liver glycogen level may be considered as the best marker for assessing antihyperglycemic activity of any drug (61). The increased hepatic glucose output in diabetes may be derived from glycogenolysis and/or gluconeogenesis as reported by Raju *et al.* (50). In general, increased hepatic glucose production, plus decreased hepatic glycogen synthesis and glycolysis, are the major symptoms in type 2 diabetes that result in hyperglycemia (54). Our results revealed an enormous depletion in hepatic and muscle glycogen contents. These results are in accordance with those of Lavoie and Van de Werve (62) and Ahmed *et al.* (46) who found that STZ-induced diabetes reduced hepatic glycogen content and increased glucose-6-phosphatase activity in diabetic rats. These results are also in agreement with the work of Grover *et al.* (61) and Pari and Suman (55) who demonstrated that decreased enzymatic activity of hexokinase has also been reported in diabetic animals, resulting in depletion of liver glycogen. These changes are obviously due to insulin deficiency, which in turn results in the activation of glycogenolytic and gluconeogenic pathways (63). The elevation of liver glycogen content in the present investigation after treatment with hesperidin and naringin is due to ameliorations of these altered enzyme activities secondary to the increase of insulin levels in the blood.

It is reported that diabetes is associated with profound alterations in lipid and lipoprotein profile (64). Changes in concentrations of plasma lipids including cholesterol and lipoprotein are complications frequently observed in patients with diabetes mellitus and certainly contributes to the development of coronary heart disease (CHD) in these patients (65). In addition, Keenoy *et al.* (66) and Ravi *et al.* (67) revealed that the abnormalities in lipid metabolism generally lead to elevation in the levels of serum lipids and lipoproteins that in turn play an important role in the occurrence of premature and severe atherosclerosis, which affects patients

with diabetes. In the present study, the rise in blood glucose was accompanied with a marked increase in TC, LDL-C, TG and reduction in HDL-C in HFD/STZ diabetic rats. These results are in agreement with the findings of Tan *et al.* (68) and Zhang *et al.* (69) who reported increased serum TG, TC and LDL-C in HFD fed STZ-induced diabetic rats. On the other hand, HDL-C revealed a different behavioral pattern where it was detectably lowered in the diabetic rats. Serum HDL-C was found to be declined in HFD/STZ type 2 diabetic rats as reported by Tan *et al.* (68) and Schalaan *et al.* (45) and in STZ/NA type 2 diabetic rats as showed by Ahmed *et al.* (46). Treatment of HFD/STZ diabetic rats with hesperidin and naringin produced great improvement of the altered serum lipid variables. These results are in agreement with the work of Gorinstein *et al.* (70) who found that hesperidin and naringin supplementation significantly increased HDL and lowers TC, LDL, total lipids and TG plasma levels in rats fed a cholesterol-containing diet. The decrease of LDL levels may occur due to the reduction of vLDL and the increase of hepatic depuration of LDL precursors (71). Both hesperidin and naringin significantly ameliorated serum HDL-C in HFD/STZ diabetic rats. That is an advantage, since HDL-C is responsible for the transportation of cholesterol from peripheral tissues to the liver for metabolism. Both agents thus have the potential to prevent the formation of atherosclerosis and coronary heart disease which are the secondary diabetic complications of severe diabetes mellitus.

In the HFD/STZ diabetic group, the elevated serum FFA level obtained in this work is in agreement with that estimated in many previous studies (72,73). Several mechanisms of how elevated FFA levels decrease insulin sensitivity have been proposed, including the Randle hypothesis concerning inhibition of insulin-stimulated glucose transport. It also should be noted that FFAs regulate gene expression, especially those involved in lipid and carbohydrate metabolism (74). Chronically elevated FFAs may also impair insulin secretory function through toxic effects on pancreatic β -cells as predicted by the "lipotoxicity hypothesis" (75). Finally, increased flux of FFAs from adipose tissue due to lipolysis of visceral adipose depots to the non-adipose tissue (e.g., liver, skeletal muscle) may lead to excessive endogenous glucose production and progression to frank type 2 diabetes (76). Therefore, decreasing plasma FFA level is proposed as a strategy for prevention and treatment of insulin resistance as stated by Na *et al.* (77). Upon treatment of the diabetic animals with hesperidin and naringin there was a decreased level of serum FFA which may participate in the insulin sensitizing effects of both

tested compounds. Also, the ability of scavenging free radicals and antioxidant properties of both agents may also participates in the hypolipidemic activity of both treatments by inactivating hepatic HMG-CoA reductase, a key enzyme, in cholesterol synthesis according to Raz *et al.* (78) who stated that inhibitors of hepatic HMG-CoA reductase are well established drugs for the treatment of hypercholesterolemia and decrease the incidence of dyslipidemia in diabetic subjects.

Diabetic dyslipidemia has long been shown to have a strong relation with CHD (65) which is the most dangerous and life threatening complication of diabetes and the risk for CHD in diabetes increases two or more folds (79). Increased TG and TC levels and decreased HDL-C represent a displayed lipid profile known as atherogenic profile which leads to the development of CHD (80). As favorable effect on lipid profile was observed following treatment with both hesperidin and naringin, this indicated that both agents might help to prevent the progression of cardiovascular diseases. In addition, several atherogenic indices such as TC/HDL-C and LDL-C/HDL-C have been used to predict CHD risk (81). Reduction of these indices in hesperidin and naringin supplemented diabetic rats strongly supported the notion that dietary supplementation with either hesperidin or naringin may lead to reduction in the risk of developing heart diseases. Also, there is some evidence to suggest that flavonoids can be incorporated into lipoprotein within the liver or intestine and subsequently be transported within the lipoproteins particle. Therefore flavonoids may be ideally located for protecting LDL from oxidation (54). Moreover, flavonoid consumption was inversely associated with mortality from CHD. Relative risks for CHD mortality and first myocardial infarction were approximately 50% lower in the highest tertile of flavonoid intake (82).

Our study revealed a significant increase in serum resistin level in HFD/STZ diabetic group in comparison with that of controls, which runs parallel to serum glucose levels, insulin levels and HOMA-IR index. The findings of this study are in line with that of Kushiyama *et al.* (83), who found that transgenic mice with hepatic resistin overexpression exhibit significant hyperglycemia, hyperlipidemia, fatty liver, and pancreatic islet enlargement, when fed a HFD. These effects may be due to resistin-induced impairment of glucose homeostasis and insulin action, thus modulating one or more steps in the insulin signaling pathway and possibly playing a role in the pathogenesis of insulin resistance (84).

The mechanism whereby resistin decreases insulin sensitivity involves several impacts. First, resistin reduces adenosine 5'-monophosphate

activated protein kinase activity in skeletal muscle, adipose tissue, and liver. These alterations decrease tissue insulin sensitivity that results in glucose intolerance, elevated FFA levels, and hypertriglyceridemia (15). Secondly, the resistin-induced reduction in IRS-1 and IRS-2 elevates mRNA levels of gluconeogenic enzymes, such as glucose-6-phosphatase and phosphoenolpyruvate carboxykinase, thus suggesting a direct resistin induction of insulin resistance in the liver (85). Thirdly, resistin decreased glycogen synthase (GS) activity both in the presence or absence of insulin; this suggests that resistin directly down-regulates GS activity (86). Furthermore, it was reported that resistin promotes lipid accumulation in human macrophages by up-regulating CD36 cell surface expression, which is one of the scavenger receptors in macrophages involved in the uptake of modified LDL (87). Based on the current data, the resistin lowering effect of hesperidin and naringin may directly participate to their hypoglycemic and hypolipidemic effects.

In contrast to resistin, HFD/STZ diabetic rats exhibited diminished serum adiponectin level and treatment with either hesperidin or naringin significantly alleviated serum adiponectin. Serum levels of adiponectin are found to be in agreement with insulin sensitivity and the reduced levels of which are associated with the etiology of T2DM and obesity (88). Also, adiponectin has been reported to sensitize the body tissues toward actions of insulin. The proposed mechanism of action for adiponectin include [1] its insulin sensitizing effect which in turn regulates glucose metabolism through stimulation of AMPK (89) [2] enhanced oxidation of muscle fat and glucose transport mediated through AMPK activation and acetyl-CoA carboxylase inhibition (90) [3] inhibition of hepatic gluconeogenesis through decrease in the expression of phosphoenolpyruvate carboxylase and glucose-6-phosphatase (89), and [4] increased fatty acid combustion and energy consumption, partly through peroxisome proliferator activated receptor- α activation, leading to decreased TG content in skeletal muscles and liver (5). Moreover, it has been shown that mice lacking adiponectin expression have reduced insulin sensitivity or are more likely to suffer from insulin resistance (91). Though, the insulin sensitizing effects of the tested flavonoids are mediated partly via increasing serum adiponectin level.

Taken together, it can be concluded that the ameliorative effect of hesperidin and naringin on carbohydrate and lipid variables may be attributed to their insulin releasing capacity, lipid lowering effect, and ameliorating the altered adiponectin and resistin levels.

Corresponding author

Ayman Moawad Mahmoud
Physiology Unit, Zoology Department, Faculty of Science, Beni-Suef University, Beni-Suef, Egypt.
Tel.; +201144168280
E-mail: aymano911@yahoo.com

References

1. American Diabetes Association (2010). Diagnosis and classification of diabetes mellitus. *Diabetes Care*; 33: (Suppl. 1) S62–S69.
2. Taskinen MR (2002). Diabetic dyslipidemia. *Atheroscler Suppl.*; 3:47–51.
3. Jenson T, Stender, Deckert T (1998). Abnormalities in plasma concentration of lipoprotein and fibrogen in type 1 (insulin dependent) diabetic patients with increased urinary albumin excretion. *Diabetology*; 31:142-6.
4. Moller D (2004). New drug targets for type 2 diabetes and the metabolic syndrome: A review. *Nature*; 414:821-7.
5. Yamauchi T, Kamon J, Ito Y, Tsuchida A, Yokomizo T, Kita S. *et al.* (2003). Cloning of adiponectin receptors that mediate anti-diabetic metabolic effects. *Nature*; 423:762–769.
6. Verges B, Petit JM, Duvillard L, Dautin G. *et al.* (2006). Adiponectin is an important determinant of apoA-I catabolism. *Arterioscler Thromb Vasc Biol.*; 26:1364–1369.
7. Kern PA, Di Gregorio GB, Lu T, Rassouli N, Ranganathan G. (2003). Adiponectin expression from human adipose tissue: relation to obesity, insulin resistance, and tumor necrosis factor- α expression. *Diabetes*; 52:1779–1785.
8. Antuna-Puente B, Feve B, Fellahi S, Bastard JP. (2008). Adipokines: the missing link between insulin resistance and obesity. *Diabetes Metabol.*; 34:2-11.
9. Trujillo ME, Scherer PE (2005). Adiponectin: journey from an adipocyte secretory protein to biomarker of the metabolic syndrome. *J Intern Med.*; 257:167–175.
10. Stepan CM, Lazar MA. The current biology of resistin. *J Intern Med* 2004; 255(4):439-447.
11. Hoseen MI, Hassan MM, Abd-Alaleem DI (2010). Faragallah EM. Serum resistin levels and haemostatic changes in experimentally induced diabetic and high fat fed rats. *J Am Science*; 6(11):217-227.
12. Stepan CM, Bailey ST, Bhat S, Brown EJ, Banerjee RR, Wright CM. *et al.* (2001). The hormone resistin links obesity to diabetes. *Nature*; 409(6818):307-312.
13. Rajala MW (2004). Role of resistin in diet-induced hepatic insulin resistance. *J Clin Invest*; 114:232–239.
14. Norata GD, Ongari M, Garlaschelli K, Raselli S, Grigore L, Catapano AL (2007). Plasma resistin

- levels correlate with determinants of the metabolic syndrome. *Eur J Endocrinol.*; 156:279–284.
15. Rajala MW, Obici S, Scherer PE, Rossetti L (2003). Adipose-derived resistin and gut-derived resistin-like molecule-beta selectively impair insulin action on glucose production. *J Clin Invest.*; 111:225–230.
 16. Lim S, Koo BK, Cho SW, Kihara S, Funahashi T, Cho YM. *et al.* (2008). Association of adiponectin and resistin with cardiovascular events in Korean patients with type 2 diabetes: the Korean atherosclerosis study (KAS): a 42-month prospective study. *Atheroscl.*; 196(1):398-404.
 17. Weikert C, Westphal S, Berger K, Dierkes J, Mohlig M, Spranger J. *et al.* (2008). Plasma resistin levels and risk of myocardial infarction and ischemic stroke. *J Clin Endocrinol Metab.*; 93(7):2647-2653.
 18. Tahrani AA, Piya MK, Kennedy A, Barnett AH (2010). Glycaemic control in type 2 diabetes: targets and new therapies. *Pharmacol Therap.*; 125:328-361.
 19. Chen H, Ward MH, Graubard BI (2002). Dietary patterns and adenocarcinoma of the esophagus and distal stomach. *Am J Clin Nutr.*; 75:137-144.
 20. Canadian Council on Animal Care (1993). Guide to the care and use of experimental animals. Vol. 2, CCAC, Ottawa, Ontario, Canada.
 21. Srinivasan K, Viswanand B, Asrat L, Kaul CL, Ramarao P (2005). Combination of high-fat diet-fed and low dose of streptozotocin-treated rat: a model for type 2 diabetes and pharmacological screening. *Pharmacol Res.*; 52:313–320.
 22. Reed MJ, Meszaros K, Entes LJ, Claypool MD, Pinkett JG, Gadbois TM. *et al.* (2000). A new rat model of type 2 diabetes, the fat-fed, streptozotocin-treated rat. *Metabol.*; 49:1390–1394.
 23. Trinder P (1969). Determination of glucose in blood using glucose oxidase with an alternative oxygen acceptor. *Ann Clin Biochem.*; 6:24–27.
 24. Little RR, Wiedmeyer HM, England JD, Wilke AL, Rohlfing CL, Wians FH. *et al.* (1992). Interlaboratory standardization of measurements of glycohemoglobins. *Clin Chem.*; 38:2472-2478.
 25. Seifter S, Dayton S, Novic B, Muntwyler E (1950). The estimation of glycogen with anthrone reagent. *Arch Biochem.*; 25:191-200.
 26. Laakso M (1993). How good a marker is insulin level for insulin resistance? *Am J Epidemiol.*; 137:959–965.
 27. American Diabetic Association (1998). Consensus development conference on insulin resistance: 5–6 November 1997. *Diabetes Care*, 21, 310–314.
 28. Haffner SM, Greenberg AS, Weston WM, Chen H, Williams K, Freed MI. (2002) Effect of rosiglitazone treatment on nontraditional markers of cardiovascular disease in patients with type 2 diabetes mellitus. *Circulation*, 106:679–684.
 29. Allain CC, Poon LS, Chan CS, Richmond W, Fu PC. Enzymatic determination of total serum cholesterol. *Clin Chem* 1974; 20(4):470-475.
 30. Tietz NW. Clinical guide to laboratory tests, Second Edition W.B. Saunders Company, Philadelphia, USA, 1990.
 31. Harris RJ. Plasma nonesterified fatty acid and blood glucose levels in healthy and hypoxemic newborn infants. *Pediatrics* 1974; 84:578-584.
 32. Venugopala Rao A, Ramakrishan S. Indirect assessment of hydroxymethylglutaryl CoA reductase (NADPH) activity in liver tissue. *Clin Chem* 1975; 21(10):1523-1525.
 33. Friedewald WT. Estimation of concentration of low-density lipoprotein cholesterol in plasma without use of the preparative ultracentrifuge. *Clin Chem* 1972; 18(7):499-502.
 34. Nobert WT. Clinical guide to laboratory tests, 3rd edition. Philadelphia: W.B. Saunders Company, 1995.
 35. International Federation of Clinical Chemistry, Scientific Committee. *J Clin Chem Clin Biochem* 1980; 18:521-534.
 36. Teitz N. (Ed.) *Fundam. Of Clin. Chem.*, W. B. Saunders Co., Philadelphia, PA 1986.
 37. Kachmar JF, Moss DW. In *Fundamentals of Clinical Chemistry*, 2nd ed. NW Tietz, Editor. WB Saunders, Philadelphia; 1976, Pp. 682.
 38. Ross R. The pathogenesis of atherosclerosis. In: *Heart disease*. Braunwald E. editor (4th edition). W. B. Saunders, Philadelphia, 1992; Pp. 1106-1124.
 39. Roa M, Blane K, Zonneberg M. One way analysis of variance. Version IA (C). PC-STAT, Program coded by University of Georgia, USA, 1985.
 40. Chandramohan G, Ignacimuthu S, Pugalendi KV. (2008) A novel compound from *Casearia esculenta* (Roxb.) root and its effect on carbohydrate metabolism in streptozotocin-diabetic rats. *Eur J Pharmacol.*; 590:437–443.
 41. Saravanan G, Ponnuragan P. Ameliorative potential of S-allyl cysteine on oxidative stress in STZ induced diabetic rats. *Chemico-Biological Interactions* 2010; doi:10.1016/j.cbi.2010.10.001.
 42. Ramachandran S, Asokkumar K, Uma Maheswari M, Ravi TK. Sivashanmugam AT. Saravanan S. *et al.* Investigation of Antidiabetic, Antihyperlipidemic, and In Vivo Antioxidant Properties of *Sphaeranthus indicus* Linn. in Type 1 Diabetic Rats: An Identification of Possible Biomarkers. *Evidence-Based Complement Altern Med* 2011; doi:10.1155/2011/571721.
 43. Reaven GM. Insulin resistance, hyperinsulinemia, hypertriglyceridemia and hypertension: parallels between human disease and rodent models. *Diabetes Care* 1991; 14:195–202.
 44. Zhang F, Ye C, Li G, Ding W, Zhou W, Zhu H. *et al.* The rat model of type 2 diabetes mellitus and its glycometabolism characters. *Experiment Animals* 2003; 52:401–407.
 45. Schaalan M, El-Abhar HS, Barakat M, El-Denshary ES. Westernized-like-diet-fed rats: effect on glucose

- homeostasis, lipid profile, and adipocyte hormones and their modulation by rosiglitazone and glimepiride. *J Diab Complic* 2009; 23:199–208.
46. Ahmed OM, Abdel-Moneim A, Abulyazid I, Mahmoud AM. Antihyperglycemic, antihyperlipidemic and antioxidant effects and the probable mechanisms of action of *Ruta graveolens* and rutin in Nicotinamide/streptozotocin diabetic albino rats. *Diabetologia Croatica* 2010; 39:15-32.
 47. Farswan M, Mazumder PM, Parcha V. Modulatory effect of an isolated compound from *Syzygium cumini* seeds on biochemical parameters of diabetes in rats. *Int J Green Pharm* 2009; 3:128-33.
 48. Beck-Nielsen H. Insulin resistance: Organ manifestations and cellular mechanisms. *Ugeskr Laeger* 2002; 164 :2130-2135.
 49. Gold AH. The effect of diabetes and insulin on liver glycogen synthetase activation. *J Biol Chem* 1970; 245:903-905.
 50. Raju J, Gupta D, Rao AR, Yadava PK, Baquer NZ. *Trigonella foenum graecum* (fenugreek) seed powder improves glucose homeostasis in alloxan diabetic rat tissues by reserving the altered glycolytic, gluconeogenic and lipogenic enzymes. *Mol Cell Biochem* 2001; 224:45-51.
 51. Powers AC. Chapter 323. Diabetes mellitus. In D. L. Kasper, A. S. Fauci, D. L. Longo, E. Braunwald, S. L. Hauser, & J. L. Jameson, Harrison's principles of internal medicine (16th ed.) 2005. The McGraw-Hill Companies, Inc.
 52. Randle PJ, Garland PB, Hales CN, Newsholme EA. The glucose fatty-acid cycle. Its role in insulin sensitivity and the metabolic disturbances of diabetes mellitus. *Lancet* 1963; 1:785–789.
 53. Song H, Shojima N, Sakoda H, Ogihara T, Fujishiro M, Katagiri H. et al. Resistin is regulated by C/EBPs, PPARs, and signal-transducing molecules. *Biochem Biophys Res Commun* 2002; 29:291–298.
 54. Jung UJ, Lee MK, Jeong KS, Choi MS. The hypoglycemic effects of hesperidin and naringin are partly mediated by hepatic glucose-regulating enzymes in C57BL/KsJ-db/db mice. *J Nutr* 2004; 134:2499-2503.
 55. Pari L, Suman S. Antihyperglycemic and antilipidperoxidative effects of flavanoid naringin in streptozotocin-nicotinamide induced diabetic rats. *Int J Biol Med Res* 2010; 1:206-210.
 56. Akiyama S, Katsumata S, Suzuki K, Ishimi Y, Wu J, Uehara M. Dietary hesperidin exerts hypoglycemic and hypolipidemic effects in streptozotocin-induced marginal type 1 diabetic rats. *J Clin Biochem Nutr* 2010; 46:87-92.
 57. Sheela CG, Augusti KT. Antidiabetic effects of S-allyl cysteine sulphoxide isolated from garlic, *Allium sativum* Linn. *Ind J Exp Biol* 1992; 30:523-526.
 58. Goldstein DE. How much do you know about glycated hemoglobin testing. *Clin Diab* 1995; 13:60–63.
 59. Choi EJ. Antioxidative effects of hesperetin against 7,12-dimethylbenz(a)anthracene-induced oxidative stress in mice. *Life Sci* 2008; 82:1059–1064.
 60. Singh D, Chander V, Chopra K. Protective effect of naringin, a bioflavonoid on ferric nitrilotriacetate-induced oxidative renal damage in rat kidney. *Toxicology* 2004; 201:1–8.
 61. Grover JK, Vats V, Rathi SS. Antihyperglycemic effect of *Eugenia jambolana* and *Tinospora cordifolia* in experimental diabetes and their effects on key metabolic enzymes involved in carbohydrate metabolism. *J Ethnopharmacol* 2000; 73:461-470.
 62. Lavoie L, Van de Werve G. Hormone-stimulated glucose production from glycogen in hepatocytes from streptozotocin diabetic rats. *Metabolism* 1991; 40:1031-1036.
 63. Pari L, Murugan P. Effect of tetrahydrocurcumin on blood glucose, plasma insulin and hepatic key enzymes in streptozotocin induced diabetic rats. *J Basic Clin Physiol Pharmacol* 2005; 16:257–274.
 64. Pushparaj PN, Low HK, Manikandan J, Tan BKH, Tan CH. Anti-diabetic effects of Cichorium intybus in streptozotocin-induced diabetic rats. *J Ethnopharmacol* 2007; 111:430–434.
 65. Wold LE, Ceylan IAF, Ren J. Oxidative stress and stress signaling: menace of diabetic cardiomyopathy. *Acta Pharmacologica Sinica* 2005; 26:908-917.
 66. Keenoy BMY, Campenhout VA, Aerts P, Vertommen , Abrams P, Gaal LFV. et al. Time course of oxidative stress status in the postprandial and postabsorptive states in type 1 diabetes mellitus: relationship to glucose and lipid changes. *J Am College Nutr* 2005; 24:474-485.
 67. Ravi K, Rajasekaran S, Subramanian S. Antihyperlipidemia effect of *Eugenia Jambolana* seed kernel on streptozotocin-induced diabetes in rats. *Food Chem Toxicol* 2005; 43:1433-1439.
 68. Tan BKH, Tan CH, Pushparaj PN. Anti-diabetic activity of the semi-purified fractions of Averrhoa bilimbi in high fat diet fed-streptozotocin-induced diabetic rats. *Life Sci* 2005; 76:2827–2839.
 69. Zhang W, Zhao J, Wang J, Pang X, Zhuang X, Zhu X, Qu W. Hypoglycemic effect of aqueous extract of sea buckthorn (*Hippophae rhamnoides* L.) seed residues in streptozotocin-induced diabetic rats. *Phytother Res* 2010; 24:228–232.
 70. Gorinstein S, Vargas OJM, Jaramillo NO, Salas IA, Ayala ALM. et al. The total polyphenols and the antioxidant potentials of some selected cereals and pseudocereals. *Eur Food Res Technol* 2007; 225:321-328.
 71. Knekt P, Kumpulainen J, Jarvinen R. Flavonoid intake and risk of chronic diseases. *Am J Clin Nutr* 2002; 76:560-568.
 72. Baldeweg SE, Golay A, Natali A, Balkau B, Del Prato S, Coppack SW. Insulin resistance, lipid and

- fatty acid concentrations in 867 healthy Europeans. *Eur J Clin Invest* 2002; **30**:45–52.
73. Abdin AA, Baalash AA, Hamooda HE. Effects of rosiglitazone and aspirin on experimental model of induced type 2 diabetes in rats: focus on insulin resistance and inflammatory markers. *J Diab Complic* 2010; **24**:168–178.
74. Evans JL, Goldfine ID, Maddux BA, Grodsky GM. Are oxidative stress activated signaling pathways mediators of insulin resistance and β -cell dysfunction? *Diabetes* 2003; **52**:1-8.
75. Unger RH. Lipotoxicity in the pathogenesis of obesity-dependent NIDDM: genetic and clinical implications. *Diabetes* 1995; **44**: 863–870.
76. Lewis GF, Carpentier A, Adeli K, Giacca A. Disordered fat storage and mobilization in the pathogenesis of insulin resistance and type 2 diabetes. *Endocrine Reviews* 2002; **23**(2):201–229.
77. Na LX, Zhang YL, Li Y, Liu LY, Li R, Kong T, Sun CH. Curcumin improves insulin resistance in skeletal muscle of rats. *Nutr Metabol Cardiovasc Diseases* 2010, 1-8.
78. Raz I, Eldor R, Cernea S, Shafir E. Diabetes, insulin resistance and derangements in lipid metabolism. Cure through intervention in fat transport and storage. *Diabetes Metab. Res Rev* 2005; **21**:3–14.
79. Haffner M. Coronary heart disease in patients with diabetes. *N Engl J Med* 2000; **342**:1040.
80. Garber AJ. Attenuating CV risk factors in patient with diabetes: Clinical evidence to clinical practice. *Diabetes Obes Metab* 2002; **4**:S5.
81. Grover SA, Levington C, Paquet S. Identifying adults at low risk for significant hyperlipidemia: a validated clinical index. *J Clin Epidemiol* 1999; **52**:49.
82. Sugiura M, Ohshima M, Ogawa K, Yano M. Chronic administration of *Satsuma mandarin* fruit improves oxidative stress in streptozotocin-induced diabetic rat liver. *Biol Pharmac Bulletin* 2006; **29**:588-591.
83. Kushiyaama A, Shojima N, Ogihara T, Inukai K, Sakoda H, Fujishiro M. Resistin-like molecule beta activates MAPKs, suppresses insulin signaling in hepatocytes, and induces diabetes, hyperlipidemia, and fatty liver in transgenic mice on a high fat diet. *J Biol Chem* 2005; **280**:42016–42025.
84. Muse ED, Obici S, Bhanot S, Monia BP, McKay RA, Rajala MW. Role of resistin in diet-induced hepatic insulin resistance. *J Clin Invest* 2004; **114**:232–239.
85. Moon B, Kwan JJ, Duddy N, Sweeney G, Begum N. Resistin inhibits glucose uptake in L6 cells independently of changes in insulin signaling and GLUT4 translocation. *Am J Physiol Endocrinol Metab* 2003; **285**: E106-15.
86. Ferrer JC, Favre C, Gomis RR, Fernandez- Novell JM, Garcıa-Rocha M, de la Iglesia N. Control of glycogen deposition. *FEBS Lett* 2003; **546**:127-32.
87. Xu W, Yu L, Zhou W, Luo M. Resistin increases lipid accumulation and CD36 expression in human macrophages. *Biochem Biophys Res Commun* 2006; **351**:376–382.
88. Statnick MA, Beavers LS, Conner LJ, Corominola H, Johnson D, Hammond CD. *et al.* Decreased expression of apM1 in omental and subcutaneous adipose tissue of humans with type 2 diabetes. *Int J Exp Diabetes Res* 2002; **1**:81-8.
89. Yamauchi T, Kamon J, Minokoshi Y, Ito Y, Waki H, Uchida S. *et al.* Adiponectin stimulates glucose utilization and fatty-acid oxidation by activating AMP-activated protein kinase. *Nat Med* 2002; **8**:1288-95.
90. Tomas E, Tsao TS, Saha AK, Murrey HE, Zhang CC, Itani SI. *et al.* Enhanced muscle fat oxidation and glucose transport by ACRP30 globular domain: acetyl-CoA carboxylase inhibition and AMP-activated protein kinase activation. *Proc Natl Acad Sci USA* 2002; **99**:16309–16313.
91. Nawrocki AR, Rajala MW, Tomas E, Pajvani UB, Saha AK, Trumbauer ME. Mice lacking adiponectin show decreased hepatic insulin sensitivity and reduced responsiveness to peroxisome proliferator-activated receptor gamma agonists. *J Biol Chem* 2006; **281**:2654-2660.

9/28/2011

Singularities of Gauss Map of Pedal Hypersurface in R^{n+1}

M. A. Soliman¹, Nassar. H. Abdel-All¹, Soad. A. Hassan¹ and E. Dahi²

¹ Department of Mathematics, Faculty of Science, Assiut University, Assiut 71516, Egypt

² Department of Mathematics, Faculty of Science, Al-Azhar University, Assiut 71524, Egypt
saodali@gmail.com

Abstract: This paper mainly studies the singularities of Gauss Map of pedal hypersurface in R^{n+1} . It contains the geometry of pedal hypersurfaces in R^{n+1} and their Gauss maps. The singularity of Gauss map of the pedal hypersurface using the rank of jacobian matrix of Gauss map is given and classified. The sets of singularities and its graphs under the Gauss map are plotted.

[M. A. Soliman, Nassar. H. Abdel-All, Soad. A. Hassan and E. Dahi. **Singularities of Gauss Map of Pedal Hypersurface in R^{n+1}** . Life Science Journal 2011; 8(4):102-107]. (ISSN: 1097-8135).
<http://www.lifesciencesite.com>.

Keywords: extrinsic differential geometry, hypersurfaces, pedal, Gauss map, theory of singularities

1. Geometry of Pedal Hypersurfaces in Euclidean Space

In this section we review the classical theory of differential geometry on hypersurfaces in Euclidean space R^{n+1} [1],[2],[3].

Let $X : U \rightarrow R^{n+1}$ be an embedding and U is an open subset of R^n , and identify M and U through the embedding X , i.e., $M = X(U)$, in this case M is called hypersurface in R^{n+1} . The tangent space of M at $p = X(u)$, $u \in U$ is

$$T_p M = \langle X_1(u), X_2(u), \dots, X_n(u) \rangle, \quad X_i = \frac{\partial X}{\partial u_i} \quad (1)$$

and the unit normal vector field along $X : U \rightarrow R^{n+1}$ is given by:

$$N(u) = \frac{X_1(u) \times X_2(u) \times \dots \times X_n(u)}{\|X_1(u) \times X_2(u) \times \dots \times X_n(u)\|} \quad (2)$$

Where

$$X_1 \times X_2 \times \dots \times X_n = \begin{vmatrix} e_1 & e_2 & \dots & e_{n+1} \\ X_1^1 & X_1^2 & \dots & X_1^{n+1} \\ X_2^1 & X_2^2 & \dots & X_2^{n+1} \\ \vdots & \vdots & \ddots & \vdots \\ X_n^1 & X_n^2 & \dots & X_n^{n+1} \end{vmatrix}$$

where $\{e_1, \dots, e_{n+1}\}$ is the canonical basis of R^{n+1} and

$$X_i = X_i^j \in T_p M \subset R^{n+1}, \quad X_i^j = \frac{\partial X_i}{\partial u_j}, \quad X = (X_i)$$

A map $G : U \rightarrow S^n$ defined by $G(u) = N(u)$ is called the Gauss map of $M = X(U)$, the derivative of the Gauss map $dG(u) : T_p M \rightarrow T_p M$ can be interpreted as a linear transformation on the tangent

space $T_p M$. The linear transformation $S_p = -dG(u)$ is called the shape operator (or Weingarten map) of the hypersurface $M = X(U)$. The eigenvalues of S_p are called the principal curvatures, and the eigenvectors of S_p are called the principal directions on M . By definition, k_p is a principal curvature if and only if $\det(S_p - k_p I) = 0$. The Gauss-Kronecker curvature of $M = X(U)$ at $p = X(u)$ is defined to be $K(u) = \det S_p$.

In the extrinsic differential geometry, totally umbilical hypersurfaces are considered to be the model hypersurfaces in Euclidean space. Since the set $\{X_i | (i = 1, \dots, n)\}$ is linearly independent, the Riemannian metric (first fundamental form) on $M = X(U)$ is given by $ds^2 = \sum_{i=1}^n g_{ij} du_i du_j$, where $g_{ij} = \langle X_i(u), X_j(u) \rangle$ for any $u \in U$. The second fundamental coefficients l_{ij} are given by $l_{ij} = \langle -N_i(u), X_j(u) \rangle = \langle N(u), X_{ij}(u) \rangle$, for any $u \in U$. Recall the following Weingarten formula [4]:

$$N_i(u) = -l_i^j(u) X_j(u) \quad (3)$$

Where $l_i^j(u) = l_{ik}(u) g^{kj}(u)$, $g^{kj}(u) = (g_{kj}(u))^{-1}$ and $g_{ik}(u) g^{kj}(u) = \delta_i^j$.

By the Weingarten formula, the Gauss-Kronecker curvature is given by

$$K(u) = \frac{\det((l_{ij})(u))}{\det((g_{\alpha\beta})(u))} \quad (4)$$

For a hypersurface $X : U \rightarrow R^{n+1}$, the pedal hypersurface of $M = X(U)$ is \hat{M} and defined by :

$$\hat{X} : U \rightarrow R^{n+1}; \quad \hat{X}(u) = \langle X(u), N(u) \rangle N(u) = S(u)N(u)$$

where $S(u) = \langle X(u), N(u) \rangle \neq 0$ is the support function on M and $\hat{M} = \hat{X}(U)$ is identified with U

through the embedding \hat{X} [3]. The tangent space of \hat{M} at $\hat{p} = \hat{X}(u)$ is defined as:

$$\hat{T}_{\hat{p}}(\hat{M})$$

The unit normal vector field along $\hat{X} : U \rightarrow \mathbb{R}^{n+1}$ can be obtained and is given by:

$$\hat{N}(u) = (-1)^n \frac{2\hat{X}(u) - X(u)}{\|X(u)\|} \quad (6)$$

Since the set $\{\hat{X}_i\}$ is linearly independent, the Riemannian induced metric on $\hat{M} = \hat{X}(U)$ (first fundamental form) is given as:

$$ds^2 = \sum_{i=1}^n \hat{g}_{ij} du_i du_j = \sum_{i=1}^n (S_{u_i} S_{u_j} + S^2 \eta_{ij}) du_i du_j$$

where $\hat{g}_{ij} = \langle \hat{X}_i(u), \hat{X}_j(u) \rangle$ and $\eta_{ij} = \langle N_i(u), N_j(u) \rangle$ is the third fundamental metric for any $u \in U$. The discriminant \hat{g} on pedal hypersurface \hat{M} is given by the relation:

$$\hat{g} = \det(\hat{g}_{ij}) = K^2(u) g(u) \|X(u)\|^2 S^{2n-2} = K(u) l(u) \|X(u)\|^2 S^{2n-2} \quad (7)$$

where $g = \det(g_{ij})$, $l = \det(l_{ij})$ and $K(u)$ is the Gaussian curvature of the hypersurface M .

The second fundamental coefficients l_{ij} are given by:

$$\hat{l}_{ij} = \langle -\hat{N}_i(u), X_j(u) \rangle = \frac{(-1)^{n+1}}{\|X(u)\|} (2\hat{g}_{ij} + S l_{ij}), \quad \hat{N}_i = \frac{\partial \hat{X}}{\partial u_i}$$

for any $u \in U$. Thus Weingarten formula on \hat{M} is given as:

$$\hat{N}_i(u) = -\hat{l}_i^j(u) \hat{X}_{u_j}(u) = \frac{(-1)^{n+2}}{\|X(u)\|} (2\delta_{ij} + S(u) l_{ik}(u) \hat{g}^{kj}(u)) \quad (8)$$

Where

$$\hat{l}_i^j(u) = \hat{l}_{ik}(u) \hat{g}^{kj}(u) \quad \text{and} \quad \hat{g}^{kj}(u) = (\hat{g}_{ij}(u))^{-1}$$

From (8) it is easy to see that, the Gauss-Kronecker curvature \hat{K} is given by:

$$\hat{K}(u) = \frac{\det(\hat{l}_{ij})}{\det(\hat{g}_{\alpha\beta})} \quad (9)$$

Explicitly the Gauss-Kronecker \hat{K} curvature can be written as:

$$\hat{K}(u) = \frac{1}{\|X(u)\|^n} \prod_{i=1}^n (2\delta_{ij} + S(u) l_{ik}(u) \hat{g}^{kj}(u)) \quad (10)$$

and the mean curvature is given by:

$$\hat{H}(u) = \frac{(-1)^{n+1}}{nK(u) \|X(u)\|^3 S(u)^{2n-3}}$$

$$(2nK(u) \|X(u)\|^2 S(u)^{2n-3} + S_i^2 l^{ii} + nS(u)^2 H(u))$$

where $H(u)$ is the mean curvature of the hypersurface M at $u \in U$. The third fundamental coefficients are given by:

$$\hat{\eta}_{ij} = \frac{(4\hat{g}_{ij}(u) + g_{ij}(u))}{\|X(u)\|^2} + \frac{(\langle X(u), X_i(u) \rangle \langle X(u), X_j(u) \rangle)}{\|X(u)\|^4} \quad (11)$$

By the definition the point $q = \hat{X}(u) \in \hat{M}$ is a parabolic point if $\hat{K}(u) = 0$. Thus the hyperbolic set on \hat{M} is defined by (using eq. (10)):

$$\prod_{i=1}^n (2\delta_{ij} + S(u) l_{ik}(u) \hat{g}^{kj}(u)) = 0$$

$$= \text{span}\{S_i N\}_{i=1}^n \oplus \text{span}\{S N_i\}_{i=1}^n$$

or explicitly by:

$$(2\delta_{ij} + S(u) l_{ik}(u) \hat{g}^{kj}(u)) = 0, \quad i = 1, 2, \dots, n \quad (12)$$

Recall the following results for the hypersurface $\hat{M} = \hat{X}(U)$ in \mathbb{R}^{n+1} [4].

Proposition 1. Suppose that $\hat{M} = \hat{X}(U)$ is totally umbilical, (\hat{k}_p is constant \hat{k}). Thus we have:

- 1) If $\hat{k} \neq 0$, then \hat{M} is a part of a hypersphere.
- 2) If $\hat{k} = 0$, then \hat{M} is a part of a hyperplane.

Proposition 2. For the hypersurface $\hat{M} = \hat{X}(U)$ in \mathbb{R}^{n+1} . The following are equivalent:

- 1) \hat{M} is totally umbilic with $\hat{k} = 0$.
- 2) The Gauss map is a constant map.
- 3) \hat{M} is a part of a hyperplane.

$$\hat{N}_1(u) \times \hat{N}_2(u) \times \dots \times \hat{N}_n(u) = \underline{0}$$

2. Singularities of Gauss Map of pedal hypersurface

The Gauss map is singular at $q \in \hat{M}$ when $\hat{K} = 0$, i.e., on the parabolic set given by equation (12).

From the relation:

$$\hat{N}_1(u) \times \hat{N}_2(u) \times \dots \times \hat{N}_n(u) = \hat{K}(u) (\hat{X}_1(u) \times \hat{X}_2(u) \times \dots \times \hat{X}_n(u)) \quad (13)$$

From this definition it follows that the Gauss map is singular when

i.e., the Jacobian matrix of the normal vector field $\hat{N}(u)$ is singular [5],[6],[7].

Gauss map has a singular point $u = u_0$ when the rank of the Jacobian matrix of $\hat{N}(u_0)$ less than n (the \dim of U), i.e.,

$$\text{rank}(D\hat{N}(u_0)) = \text{rank}((\hat{N}_1(u_0) \times \hat{N}_2(u_0) \times \dots \times \hat{N}_n(u_0))) < n \quad (14)$$

To study the singular points of Gauss map we make a modification of Gauss map as follows: if the Gauss map has a singular point we make projection of $N(u)$ to the $(n+1)$ hyperplanes projections and find the set of singular points of it (discriminant set). Thus we have

$$\text{Singular set } (s) = \det \left(\frac{\partial(\hat{N}^1(u), \hat{N}^2(u), \dots, \hat{N}^k(u), \dots, \hat{N}^{n+1}(u))}{\partial(u_1, u_2, \dots, u_n)} \right) = 0 \quad (15)$$

where the position $\hat{N}^k(u)$ indicates that the component $\hat{N}^k(u)$ is missing. The singular set give us a new hypersurface with dimension n which can be written, using the Mong form, as the following:

$$u_n = Z(u_1, u_2, \dots, u_{n-1}) \quad (16)$$

The parametrization (16) define a hypersurface (singular set) contains or may not contains singular points inheritance from the main hypersurface M . For study the graph of singular set under the Gauss map, consider the form

$$\hat{N}(s) = \hat{N}(u_1, u_2, \dots, u_n) = \hat{N}(u_1, u_2, \dots, Z(u_1, u_2, \dots, u_{n-1})) \quad (17)$$

Definition 1. [8] A map $f: R^n \rightarrow R^m$ has a singularity of type S_k at the point u_0 if the rank of f at u_0 is $\min(m, n) - k$, the number k is called the deficiency of the singularity, if $k = 0$ then u_0 is regular point.

Definition 2. [9] The level set attached to the hypersurface M is defined as the following: let $u_n = Z(u_1, u_2, \dots, u_{n-1}) = c$, c is constant, if $c = 0$ that given the level set $V_0 = \{(u_1, u_2, \dots, u_{n-1}): u_n = 0\}$ and the other level sets are

$$V_c = \{(u_1, u_2, \dots, u_{n-1}): u_n = c\}, \quad c \neq 0$$

Another version of the definition of level sets is contours as given in the following

Definition 3. We say the point p on a surface M with a parametric representation is a contour point if and only if $N \cdot pc = 0$

Where N is the normal vector field on the surface M and c is the view point. The contour line or contour, for short, of a surface is the set of all its contour points.

The determination of the contour line of a surface in the general case involves a numerical method to find the zeros of a real-valued function of n real variables in a domain $(u^1, u^2, \dots, u^n) \in U$. An algorithm and its implementation can be found in [10].

3. Application

As an application, we consider a hypersurface $M \in R^4$, i.e., we try to study the singularities of Gauss map of pedal hypersurface \hat{M} to the hypersurface M given by:

$$M : x_4 = x_1^2 + x_2^2 - x_3^2 \quad (18)$$

This hypersurface can be given by the regular parametrization

$$M : X(u, v, w) = \{u, v, w, f(u, v, w)\}, \quad (19)$$

$$f = u^2 + v^2 - w^2, \quad (u, v, w) \in U \subset R^3$$

The normal vector field on the hypersurface (19) is given as:

$$N(u, v, w) = \frac{1}{\sqrt{g}} \{-2u, -2v, 2w, 1\} \quad (20)$$

Where $g = 1 + 4u^2 + 4v^2 + 4w^2 \neq 0$

The support function S on the hypersurface M is given by:

$$S(u, v, w) = \frac{-f}{\sqrt{g}} \quad (21)$$

Thus the pedal hypersurface \hat{M} attached to the given hypersurface M is defined by (from (20),(21)):

$$\hat{M} : \hat{X}(u, v, w) = \frac{f}{g} \{2u, 2v, -2w, 1\} \quad (22)$$

The normal vector field \hat{N} on a hypersurface \hat{M} can be obtained (from (22)) as in the form:

$$\hat{N}(u, v, w) = \frac{-8f^2}{g^4} \{u(1+8w^2), v(1+8w^2), w(1+8u^2+8v^2), f(3+4u^2+4v^2+4w^2)\} \quad (23)$$

The Jacobian matrix (derivative) of $\hat{N}(u, v, w)$ can be written in the following form:

$$D\hat{N}(u, v, w) = \begin{pmatrix} \hat{N}_u^{(1)} & \hat{N}_v^{(1)} & \hat{N}_w^{(1)} \\ \hat{N}_u^{(2)} & \hat{N}_v^{(2)} & \hat{N}_w^{(2)} \\ \hat{N}_u^{(3)} & \hat{N}_v^{(3)} & \hat{N}_w^{(3)} \\ \hat{N}_u^{(4)} & \hat{N}_v^{(4)} & \hat{N}_w^{(4)} \end{pmatrix} \quad (24)$$

The factors in the matrix of equation (24) are calculated.

The rank of $D\hat{N}(u, v, w)$ at $(0, 0, 0)$ is equal to zero, so $\hat{N}(u, v, w)$ is singular at $(0, 0, 0)$. Thus we have the following:

Lemma 1. The Gauss map of \hat{M} has a singularity of type S_3 at the origin point.

To study the singularities of Gauss map of pedal hypersurface, we use the orthogonal projections on the hyperplanes $x_i = 0$; $i = 1, 2, 3, 4$. Thus we have four surfaces are denoted by σ_i , respectively, which are given explicitly by as (Fig(1),(2)) :

- (1) $\sigma_4 : x_4 = 0, x_1^2 + x_2^2 - x_3^2 = 0$ (cone).
- (2) $\sigma_3 : x_3 = 0, x_4 - x_1^2 - x_2^2 = 0$ (paraboloid of revolution).
- (3) $\sigma_2 : x_2 = 0, x_4 - x_1^2 + x_3^2 = 0$ (hyperbolic paraboloid).
- (4) $\sigma_1 : x_1 = 0, x_4 - x_2^2 + x_3^2 = 0$ (hyperbolic paraboloid).

Thus, we have 4 parabolic sets $S_I, S_{II}, S_{III}, S_{IV}$ corresponding to the hyperplanes X_i respectively.

Using the modified normal vector field $\hat{N}_{mod}(u, v, w)$ for each parabolic set as in the following:

I- For the surface σ_4 , we have a modified normal vector field, as in the form:

$$S_I : \hat{N}_{mod}(u, v, w) = \frac{-8f^2}{g^4} \{u(1+8w^2), v(1+8w^2), w(1+8u^2+8v^2)\} \quad (25)$$

The singular (discriminant or parabolic set) set in this case is given from:

$$S_I = \det(D\hat{N}_{mod}(u, v, w)) = -\frac{512}{g^{18}} (f)^6 (1+8w^2) (5+28v^2+28w^2+4(7u^2-24u^4-48u^2v^2-24v^4+(u^2+v^2)(3+2u^2+2v^2))w^2+8(-3+8u^2+8v^2)w^4) = 0 \quad (26)$$

Since $1+8w^2 \neq 0 (w \in \mathbb{R})$, thus the singular set S_I consists of 2 types of singularity as in the following (fig. 3):

$$S_{I_1} : f = 0, \\ S_{I_2} : (5+28v^2+28w^2+4(7u^2-24u^4-48u^2v^2-24v^4+32(u^2+v^2)(3+2u^2+2v^2))w^2+8(-3+8u^2+8v^2)w^4) = 0 \quad (27)$$

Then the parabolic surfaces M_{I_1} corresponding to S_{I_1} , is given by the parametrization:

$$M_{I_1} : (u, v, \sqrt{u^2+v^2}) \text{ and } \hat{N}_{mod}(M_{I_1}) = (0, 0, 0) \quad (28)$$

For the 2nd type S_{I_2} we have four roots, $w_i (i=1, 2, 3, 4)$ as functions in u and v , so we have four pranches $S_{I_{2i}}$, $i=1, 2, 3, 4$ and their corresponding parabolic surfaces $M_{I_{2i}}$ are given as:

$$M_{I_{2i}} : (u, v, w_i(u, v))$$

The surfaces S_{I_2} under the modified normal vector field $\hat{N}_{mod}(u, v, w)$ and their contours are shown by the fig. ((4),(5)).

II- For the surface σ_3 , we have a modified normal vector field, as in the form:

$$S_{II} : \hat{N}_{mod}(u, v, w) = \frac{-8f^2}{g^4} \{u(1+8w^2), v(1+8w^2), f(3+4u^2+4v^2+4w^2)\} \quad (29)$$

The singular (discriminant or parabolic set) set in this case is given from:

$$S_{II} = \det(D\hat{N}(u, v, w)) = -\frac{1024w}{g^{18}} f^6 (1+8w^2) (-9-12v^2-76w^2+4(-3u^2+56u^4+112u^2v^2+56v^4+32(u^2+v^2)(-1+6u^2+6v^2))w^2+8(-1+24u^2+24v^2)w^4) = 0 \quad (30)$$

Since $1+8w^2 \neq 0 (w \in \mathbb{R})$, thus the singular set S_{II} consists of 3 types of singularity as in the following (fig. 6):

$$S_{II_0} : w = 0, \quad S_{II_1} : f = 0, \\ S_{II_2} : (-9-12v^2-76w^2+4(-3u^2+56u^4+112u^2v^2+56v^4+32(u^2+v^2)(-1+6u^2+6v^2))w^2+8(-1+24u^2+24v^2)w^4) = 0 \quad (31)$$

Then the parabolic surfaces M_{II_1} corresponding to S_{II_1} , is given by the parametrization:

$$M_{II_1} : (u, v, \sqrt{u^2+v^2}) \text{ and } \hat{N}_{mod}(M_{II_1}) = (0, 0, 0) \quad (32)$$

For the 3rd type S_{II_2} we have four roots, $w_i (i=1, 2, 3, 4)$ as functions in u and v , so we have four pranches $S_{II_{2i}}$, $i=1, 2, 3, 4$ and their corresponding parabolic surfaces $M_{II_{2i}}$ are given as:

$$M_{II_{2i}} : (u, v, w_i(u, v))$$

The surfaces S_{II_0} and $S_{II_{2i}}$ under the modified normal vector field $\hat{N}_{mod}(u, v, w)$ and their contours are shown by the fig. (7), (8),(9).

III- For the surface σ_2 , we have a modified normal vector field, as in the form:

$$S_{III} : \hat{N}_{mod}(u, v, w) = \frac{-8f^2}{g^4} \{u(1+8w^2), w(1+8u^2+8v^2), f(3+4u^2+4v^2+4w^2)\} \quad (33)$$

Similarly as in the case I, II, $1+8w^2 \neq 0 (w \in \mathbb{R})$, thus the singular set S_{III} consists of 3 types of singularity as in the following (fig. 10)

$$S_{III_0} : v = 0, \quad S_{III_1} : f = 0, \\ S_{III_2} : (-9-76v^2-4(8u^4+8v^4+u^2(19+16v^2))-12w^2+128(u^2+v^2)(-1+6u^2+6v^2))w^2+32(7+24u^2+24v^2)w^4) = 0 \quad (34)$$

Then the parabolic surfaces M_{III_1} corresponding to S_{III_1} , is given by the parametrization:

$$M_{III_1} : (u, v, \sqrt{u^2+v^2}) \text{ and } \hat{N}_{mod}(M_{III_1}) = (0, 0, 0) \quad (35)$$

For the 3rd type S_{III_2} we have four roots, $v_i (i=1, 2, 3, 4)$ as functions in u and w , so we have four pranches $S_{III_{2i}}$, $i=1, 2, 3, 4$ and their corresponding parabolic surfaces $M_{III_{2i}}$ are given as:

$$M_{III_{2i}} : (u, v, v_i(u, w))$$

The surfaces S_{III_0} and $S_{III_{2i}}$ under the modified normal vector field $\hat{N}_{mod}(u, v, w)$ and their contours are shown by the fig. (11), (12),(13).

IV- For the surface σ_1 , we have a modified normal vector field, as in the form:

$$S_{IV} : \hat{N}_{mod}(u, v, w) = \frac{-8f^2}{g^4} \{v(1+8u^2), w(1+8u^2+8v^2), f(3+4u^2+4v^2+4w^2)\} \quad (36)$$

Similarly the singular set of this case is given from:

$$S_{IV} = \det(D\hat{N}(u, v, w)) = uf^6 (-9 - 76v^2 - 4(8u^4 + 8v^4 + u^2(19 + 16v^2)) - 12w^2 + 128 (u^2 + v^2(-1 + 6u^2 + 6v^2)w^2 + 32(7 + 24u^2 + 24v^2)w^4) = 0 \quad (37)$$

Thus the singular set S_{IV} consists of 3 types S_{IV_0} , S_{IV_1} , S_{IV_2} corresponding to (fig. 10):

$$u = 0, \quad f = 0, (-9 - 76v^2 - 4(8u^4 + 8v^4 + u^2(19 + 16v^2)) - 12w^2 + 128 (u^2 + v^2(-1 + 6u^2 + 6v^2)w^2 + 32(7 + 24u^2 + 24v^2)w^4) = 0 \quad (38)$$

Respectively.

Then the parabolic surfaces corresponding to S_{IV_1} is coincident with:

$$M_{IV_1} : (u, v, \sqrt{u^2 + v^2}) \text{ and } \hat{N}_{mod}(M_{IV_1}) = (0, 0, 0) \quad (39)$$

For the 3rd type S_{IV_2} we have four roots, $u_i(i=1, 2, 3, 4)$ as functions in v and w , so we have four pranches $S_{IV_{2i}}$, $i=1, 2, 3, 4$ and their corresponding parabolic surfaces $M_{IV_{2i}}$ are given as:

$$M_{IV_{2i}} : (u, v, v_i(u, w))$$

The surfaces S_{IV_0} and $S_{IV_{2i}}$ under the modified normal vector field $\hat{N}_{mod}(u, v, w)$ and their contours are shown by the fig. (11), (12),(13).

4. Conclusion

From (28), (32), (35) and (39), one can see that there exist a common intersection between the singular sets and the four projections where $M_{I_1} \equiv M_{II_1} \equiv M_{III_1} \equiv M_{IV_1}$ and $M_{I_2} \equiv M_{II_2} \equiv M_{III_2} \equiv M_{IV_2}$. The analytical solutions for the singularities of the Gauss maps and their contours on the pedal hypersurface are geometrically interpreted as show in fig. ((4), (5), (7), (8), (9), (11),(12), (13))(left). Also, the contour problem and the problem to find lines of intersection of surfaces and planes has been solved in the general case as shown in fig. ((4), (5), (7), (8), (9), (11), (12), (13))(right).

Figures



Figure 1: σ_4 (left), σ_3 (right)



Figure 2: σ_2 or σ_1

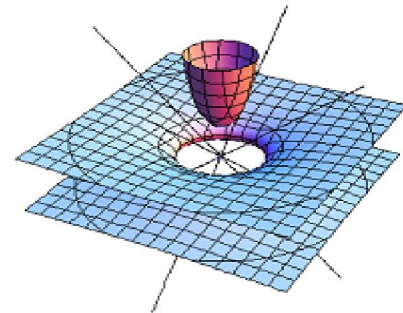

Figure 3: The singular set S_I

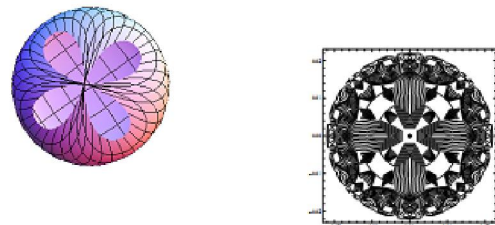

Figure 4: The image of singular $S_{I_{21}} \equiv S_{I_{22}}$ and its contours

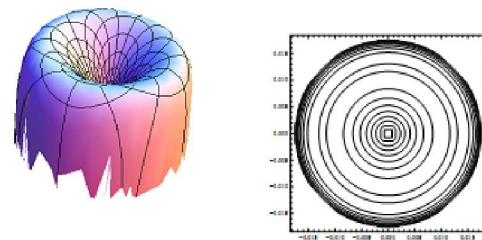

Figure 5: The image of singular $S_{I_{23}} \equiv S_{I_{24}}$ and its contours

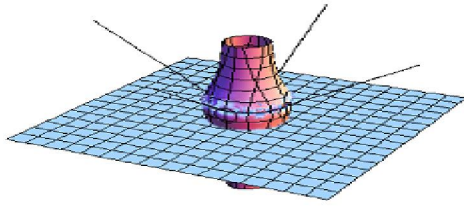

Figure 6: The singular set S_{II}

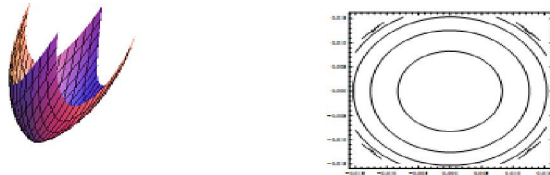

Figure 7: The image of singular S_{III_0} and its contours

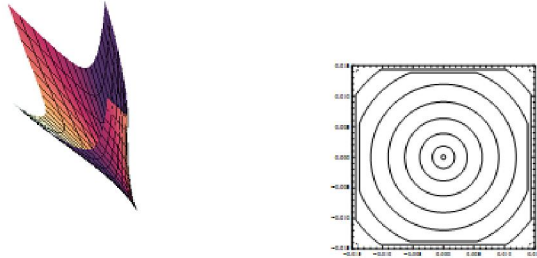

Figure 8: The image of singular $S_{III_{21}} \equiv S_{III_{22}}$ and its contours

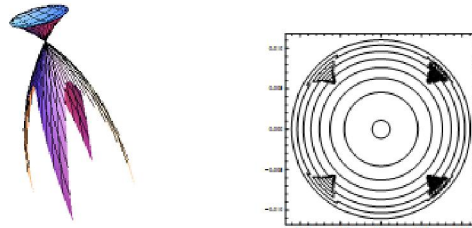

Figure 9: The image of singular $S_{III_{23}} \equiv S_{III_{24}}$ and its contours

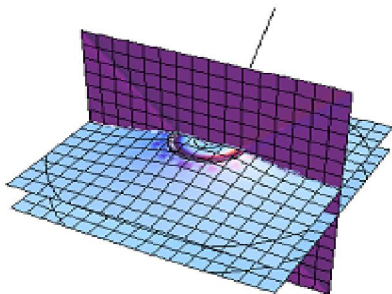

Figure 10: The singular set $S_{III} \equiv S_{IV}$

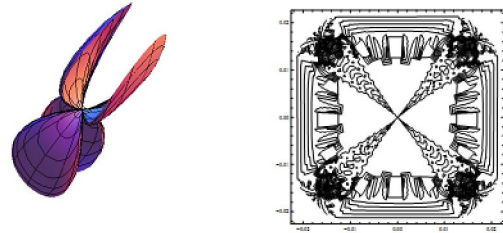

Figure 11: The image of singular set $S_{III_0} \equiv S_{IV_0}$ and its contours

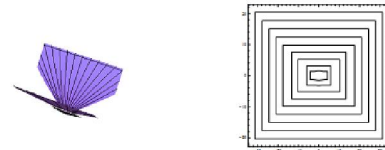

Figure 12: The image of singular set $S_{III_{21}} \equiv S_{III_{22}} \equiv S_{IV_{21}} \equiv S_{IV_{22}}$ and its contours

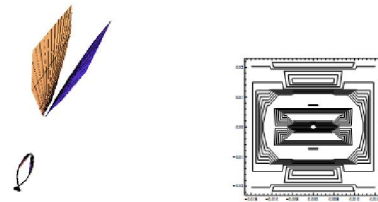

Figure 13: The image of singular set $S_{III_{23}} \equiv S_{III_{24}} \equiv S_{IV_{23}} \equiv S_{IV_{24}}$ and its contours

References

1. Do Carmo, M.P., Differential Geometry of Curves and Surfaces, Prentice-Hall, (1976).
2. Do Carmo, M.P., Riemannian Geometry, Birkhuser Basel, (1992).
3. Gry, A, Modern differential Geometry of Curves and Surfaces, studies in advanced
4. IZUMIYA, S: Differential Geometry from the viewp oint of Lagrangian or Legen-drian singularity theory; Septemb er 29, (2005).
5. Banchoff, T, "Cusps of Gauss mappings" Publisher: Longman Science Technology, May, (1986).
6. Arnol'd, V. I, The Theory of Singularities and Its Applications; Cambridge Univ. Press, Cambridge , (1991).
7. Yung-Chen Lu: Singularity Theory and an Introduction to Catastrophe Theory; Springer- Verlag, New York, Inc (1976).
8. Golubitsky, M, Guillemin, V, Stable mappings and thier singularities; Springer-Verlag, New York, Inc, (1973).
9. Arnol'd, V. I, Gusein-Zade, S. M and Varchenko, A. N, Singularities of Differentiable Maps vol. I I. Birkhauser (1988).
10. Failing, M, Malkowsky, E, Ein effizienter Nullstellenalgorithmus zur computer-grafischen Darstellung sp ezieller Kurven und Flächen, Mitt. Math. Sem. Giessen, 229, (1996), 11-25.

10/3/2011

Effects of arbuscular mycorrhizal fungi against apple Powdery Mildew disease

Zohreh Yousefi¹, Hossein Riahi¹, Hossein Khabbaz-Jolfaei² and Sima Zanganeh³

¹Faculty of Biological Sciences, Shahid Beheshti University, Tehran, Iran.

²Department of Biological Control, Iranian Research Institute of Plant Protection, Tehran, Iran.

³Department of Botany, Plant Pests & Diseases Research Institute, Shahid Beheshti University, Tehran, Iran.
m.yousefi65@yahoo.com

Abstract: The study was conducted to examine effects of mixture of arbuscular mycorrhizal fungi (AMF) and two most prevalent fungicides on Powdery Mildew disease of apple seedlings (Maling merton, MM₁₁₁). Twenty seedlings were subjected to completely randomized design (CRD) in the following treatments (5 replicates): control (non-AMF mixture, non-fungicide, T1), non-AMF mixture + fungicide Flint in 6th week (T2), non-AMF mixture + fungicide Strobry in 6th week (T3) and AMF mixture (T4), which were monitored for a period of 9 week. Seedlings were exposed to powdery mildew on 6th week and only T3 and T4 plants sprayed one time by fungicides after developing mildew colonies on the leaves. Mildew colonies counted on the all positions of apple seedling leaves (-4 to 4) after a 25-d-treating period that was started from week 6. Results indicated that the most mildew colonies were related to control plants, while lowest colonies numbers were observed in plants treated by Flint (T2), and followed by those inoculated by AMF without using any fungicide (T4). It was concluded that soil inoculation by mixture of AMF had effects similar to Flint and better than Strobry fungicide on decreasing powdery mildew colonies in apple seedling and thus, the combined use of both AMF and fungicides can be considered as a protective strategy against powdery mildew of apple. [Yousefi, Z., Riahi, H., Khabbaz-Jolfaei H., Zanganeh S. **Effects of arbuscular mycorrhizal fungi against apple Powdery Mildew disease.** Life Science Journal. 2011;8(4):108-112] (ISSN:1097-8135). <http://www.lifesciencesite.com>.

Keywords: Arbuscular mycorrhizal fungi, fungicide, Powdery Mildew, apple seedling

1. Introduction

Biological control of plant pathogens is currently accepted as a key practice in sustainable agriculture because it is based on the management of a natural resource. Common benefits for the plant are improved plant nutrition and/or increased capability to cope with adverse conditions. In the case of arbuscular mycorrhizal (AM) associations, the symbioses alter plant physiology, leading to a better mineral nutrition and to increased resistance/tolerance to biotic and abiotic stresses and or pathogens. Enhanced resistance/tolerance to soil-borne pathogens has been widely reported in mycorrhizal plants (Whipps, 2004).

Powdery mildew (PM), caused by *Podosphaera leucotricha* (Ell. & Ev.) Salm., caused by *P. leucotricha* is an important disease of apple in Iran, Islamic Republic of. Disease severity and need for control measures are related to host susceptibility and to the intended market for the cultivar (Yoder and Hickey, 1983). In Iran the very susceptible apple cultivars, such as Maling merton (MM₁₁₁) and Golden Delicious, are treated regularly with fungicides for control of fruit russet. The fungicides most commonly used for powdery mildew. The reduction of primary inoculum and the protection of leaves, fruit and buds from secondary infections are two areas of concern for effective disease control measures. Timely application of fungicides is widely

used to prevent new infections and to reduce the number of spores produced on new lesions.

The most promising new fungicides for control powdery mildew are the broad-spectrum, sterol-inhibiting compounds (Ogawa and English 1991). Strobry and Flint are often called strobry fungicides and are effective for controlling Black Spot (scab), mildew, and black rot. They provide adequate control of rust diseases when applied ahead of rains, but they have very little post-infection activity against rust diseases. For apple scab and mildew, they can provide roughly 48 hr. of post-infection activity, but they are not effective for arresting apple scab after lesions are visible on foliage.

All strobry-containing fungicides carry labels stating that combined usage for any product in this group is limited to four applications per year. Thus, one can apply a maximum of four sprays per year that contain Strobry, Flint, or Pristine; otherwise controlling disease is not guarantee. For example, if Flint is applied three times to control mildew, then Strobry can be used only one time during summer. Based on using mentioned fungicides (methods and sprays rates) for control powdery mildew, it is detected that the additional time is required for a good controlling plants against types of pathogens that markedly reduce fruit quality, while there is several biological solutions for improving resistance of plants via boosting mineral nutrition against

different pathogens or the aboveground attackers (Poza and Azcón-Aguilar, 2007). Colonization of the original soil by AMF can boost resistance/tolerance of plant such as apple seedling against powdery mildew in an uninterrupted manner without spending additional costs to fungicides, repetitious sprays times as well as labor costs.

Although Flint and Strobry was registered for the control of powdery mildew on apples and grapes in Iran, it is unclear whether soil inoculated by AMF are comparable to these DMI fungicides, which are used to control powdery mildew on apples in Iran. Hence, this study compares the activities of arbuscular mycorrhizal fungi in compared to DMI fungicides on mildew of apple plants under controlled conditions in the greenhouse.

2. Material and methods

The study was conducted during the 2011/04 season in Iran on Maling merton (MM₁₁₁) apple seedlings which cultivated in soil with and without AMF, infected to powdery mildew (*Podosphaera leucotricha*) and treated by fungicides.

The fungicides used in these experiments [Flint and strobry, Kersoxim-methyl and Trifloxy strobilin (% 50) WG, are a pre-mix products containing the strobilurin trifloxystrobin; registered in pome and stone fruits] were commercial formulations provided by the manufacturers.

MM₁₁₁ apple seedlings were planted through tissue culture to free from any contamination by microorganisms in Institute of tissue culture, Pishtaz Bldg., Karaj/Safadasht, Iran then all seedlings replaced in 10-cm dia. pots in a soil mixture containing equal volumes of loam, sand and vermiculite, perlite and coco-pit. Selected seedlings for trial were transferred to larger pots (35-cm dia.) containing 50% sterile sand and 50% AMF-inoculated soil. Prior to starting the experiment inoculation concentration of AMF were cleaned from soil of all new pots with the exception of those selected as mycorrhizal treatment (5 pots).

Apple seedlings on MM₁₁₁ rootstocks had approximately 17±2 cm length with 3-month age. Twenty seedlings were subjected to completely randomized design (CRD) in the following treatments (5 replicates): control (non-AMF mixture, non-fungicide, T1), non-AMF mixture + fungicide Flint in 6th week (T2), non-AMF mixture + fungicide Strobry in 6th week (T3) and AMF mixture (T4), which were monitored throughout 9 week. Seedlings were exposed to powdery mildew on 6th wk. and only T3 and T4 plants sprayed one time by fungicides after developing mildew colonies on the leaves. Mildew colonies counted on the all positions of apple

seedling leaves (-4 to 4) after a 25-d-treating period that started from week 6.

The active ingredient (a.i.) dosages of fungicides applied for the DMI materials were those recommended by the manufacturer. The experimental pots were placed in the greenhouse (22°C day, 18°C night, 77- 84% RH) for germination and subsequent growth for approximately 9 weeks so that plants protected against pesticides for disease or insect up to 6th week.

The inoculum source was infected apple shoots from an eight year old Jonagold tree in Research Station orchard in the Iranian Research Institute of Plant Protection. The fungus was identified as *Podosphaera leucotricha* on the basis of symptom development and a comparison of the morphological characters of the conidia and fruiting bodies with those described for *P. leucotricha* by Ogawa and English (1991). The infected shoots were placed in a 1°C cold storage room for approximately 4 hrs while the fungicide suspensions were being prepared. Maling merton (MM₁₁₁) seedlings were sprayed to runoff using a hand operated mister. The leaves were allowed to dry for 30-min before inoculation with *P. leucotricha* conidia. Each treatment consisted of 5 seedlings (replicates). A conidial suspension was prepared by brushing conidia from diseased shoots into sterile water containing 20 pl/mL of Triton X 100 according to used method of Dekker (1982). The concentration was adjusted to 8.0 x 10¹¹ conidia/mL with a haemocytometer. Within 15-min of preparation the suspension was sprayed on the leaves. The seedlings were inoculated using the method Dekker (1982) developed to evaluate powdery mildew on MM₁₁₁ leaves.

Mildew development was estimated by counting colonies on leaves day 25 after infection to mildew pathogen. Each small white spot at least 3-mm in diameter was counted as a colony. Mildew colonies were counted on both surfaces of nine leaves at positions -4 to +4, where leaf 0 was the youngest leaf behind the shoot apex at the time of inoculation and -4 was the next unrolled leaf and youngest leaf at the shoot tip when the colonies were counted (Jeger et al. 1986). One plant was removed from each treatment because it had on average fifteen times more colonies than the mean, and therefore had been apparently infected with powdery mildew before the start of the experimental period of resistance.

2.1. Statistical analyses

All data from the trial were analyzed by ANOVA using the GLM procedure of SAS software (SAS Institute, 1998), which was appropriated for a randomized complete block design. When significances were detected (P < 0.05), values were

compared post-hoc using the Duncan test. The results are expressed as averages and their Standard Error (SE).

3. Results

Results of colonies numbers on leaves in different positions are shown in Table 1. The controlling disease by Flint was significantly boosted in plants of group 2 (Table 1), and values followed by plants cultivated in AMF-fertilized-soil after infected to *Podosphaera leucotricha* ($P < 0.01$) (Figure 1). Results indicated that the most mildew colonies were

related to control plants, while lowest colonies numbers were observed in plants treated by Flint (T2), and followed by those inoculated by AMF without using any fungicide (T4).

No significant differences in mildew colonies numbers were observed between treatments in the leaves of positions 4, 3 and 2, while mildew colonies of the leaves of positions 1 to -4 were significantly ($P < 0.01$) decreased by Flint, followed by mixture of AMF. Mildew colonies in the leaves of plants treated by Strobry not significantly decreased in position -4.

Table 1. Comparing averages of colonies numbers of leaves in positions (-4 to +4)

Treatment Traits	Treatment 1	Treatment 1	Treatment 1	Treatment 1	Standard errors	Significant level
Leave -4	1.20 ^{ab}	0.00 ^b	2.00 ^a	0.60 ^{ab}	0.316	**
Leave -3	3.80 ^a	0.00 ^b	2.20 ^a	0.20 ^b	0.282	**
Leave -2	3.60 ^a	0.00 ^b	2.40 ^{ab}	0.80 ^a	0.339	**
Leave -1	2.40 ^a	0.00 ^b	2.10 ^a	0.80 ^a	0.367	**
Leave 0	3.60 ^a	0.20 ^a	0.60 ^{ab}	0.20 ^b	0.353	**
Leave +1	2.00 ^a	0.00 ^b	0.40 ^{ab}	0.80 ^a	0.316	**
Leave +2	0.60 ^b	0.00 ^b	0.00 ^b	0.00 ^b	0.200	ns
Leave +3	0.80 ^a	0.00 ^b	0.40 ^{ab}	0.00 ^b	0.223	ns
Leave +4	0.80 ^{ab}	0.00 ^b	0.40 ^a	0.00 ^b	0.223	ns

^{a,b} Values in the same row and variable with no common superscript differ significantly; Values are means of 5 observations per treatment and their standard errors. Treatment 1 (T1) = control (non-AMF mixture, non-fungicide); T2 = non-AMF mixture + fungicide Flint in 6th week; T3 = non-AMF mixture + fungicide Strobry in 6th week; T4 = AMF mixture; NS= $p > 0.05$; * = $p < 0.05$; ** = $p < 0.01$.

4. Discussion

Comparing average of colonies numbers in leaves of apple seedlings between treatments revealed a significant different ($P < 0.01$); so that, average of highest colonies numbers was related to T1 and T3 (control and Strobry-treated groups, respectively) and lowest value was related to plants treated by Flint in 6th week (T2) and those planted in AMF-inoculated-soil (T4). Data from current study confirmed that groups fertilized by mycorrhizal inoculum had lower colonies similar to those treated by Flint. Therefore, this result revealed that the soil contain arbuscular mycorrhizal fungi has a continual effect on prevent further contamination of the older leaves.

Results from the current study are agreement with researchers (by fungicides: Wilcox et al., 1992; Sholberg and Haag, 1994; and by AMF-inoculated-soil: Azcón-Aguilar and Barea, 1996; Pozo et al., 2008).

Daft and Nicolson (2011) by study of influence of inoculum concentration of mycorrhiza on growth and infection in tomato found that enrichment of soil using inoculum concentration of arbuscular mycorrhizal fungi were significantly affected and improved plant growth and crop production. To date the most studies were done related to effects of soil inoculation by AMF on final level of root diseases and rot (Fortuna et al., 1996; Xu and Madden, 2002; Fortin et al., 2002; Turk et al., 2006; Redecker and Raab, 2006; Wehner et al., 2009; Mitre et al., 2010) while there is little reference and relatively centralized researches which examined the secondary effect of mycorrhizal fungi-inoculated-soils in plants on containment of pollution of leaves like powdery mildew (Azcón-Aguilar and Barea, 1996; Whipps, 2004; Pozo et al., 2008). Nowadays the chemical fungicide were widely used by farmers and producers of agricultural products against powdery mildew disease; hence, most researches is focused on the strongest and most safely fungicides for effective

disease control and often non-chemical methods such as biological control using AMF are of secondary importance (Valiuškaitė et al., 2009).

Fortuna et al. (1996) reported that soil contain arbuscular mycorrhizal fungi (AMF) via an beneficial interactions between plant and AMF improved plant nutrition and/or increased capability to cope with adverse conditions (Wehner et al., 2009).

5. Conclusion

Results indicated that soil inoculation via AMF (T2) for apple seedlings (MM₁₁₁) was effective on decreasing percentage of infection similar to those treated by fungicide Flint. It was concluded that plants cultivated in soil inoculated to AMF throughout 6 weeks had higher resistance against *Podosphaera leucotricha* fungi as an agent of powdery mildew disease in apple seedling and it can be considered as a protective strategy in fruiting plants for reduce the negative effects of infectious fungi. From the presented study it is suggested that the combined use of both arbuscular mycorrhizal fungi and fungicides is an effective strategy to management of diseases.

Corresponding Author:

Engineer Zohre Yousefi
Faculty of Biological Sciences,
Shahid Beheshti University, Tehran, Iran.
E-mail: myousefi65@gmail.com

Acknowledgements

The manuscript was summarized from the project of master thesis in Faculty of Biological Sciences, Shahid Beheshti University, Tehran. Authors are grateful to Dep. Biological Control, Iranian Research Institute of Plant Protection, Tehran, Iran for practical support including provide experimental greenhouse and technical support for performing this research and also grateful to Hossein Khabbaz-Jolfaei, assistant professor of above-mentioned center for his technical assistance during the experimental period and all steps of professional education and instruction. We would like to thank Prof. Dr. Hossein Riahi for directing to us with his experiences in research and also for financial support to carry out this work and reports.

References

- Whipps JM. Prospects and limitations for mycorrhizas in biocontrol of root pathogens. *Can J Bot*, 2004; 82: 1198 – 1227
- Pozo MJ, Azcón-Aguilar C. Unravelling mycorrhiza induced resistance. *Curr Opin Plant Biol*, 2007; 10: 393 – 398
- Yoder KS, Hickey KD. Control of apple powdery mildew in the Mid-Atlantic region. *Plant Dis*. 1983; 67: 245-248.
- Ogawa JM, English H. Powdery mildew of pome fruit. Pages 50-53 in: *Diseases of Temperate Zone Tree Fruit and Nut Crops*. University of California, Division of Agriculture and Natural Resources, Publication 3345, Oakland, CA. 1991.
- Dekker J. Method of fungicide resistance in powdery mildew of cucumber - FAO Method No. 27. Food and Agriculture Organization of the United Nations. FAO Plant Bulletin, 1982; 3059-61.
- Jeger MJ, Butt DJ, Swait AAJ. Components of resistance of apple to powdery mildew (*Podosphaera leucotricha*). *Plant Pathology*, 1986; 35:477-490.
- SAS Institute Inc. SAS User's Guide: Statistics. SAS Institute Inc., Cary, NC. 1998.
- Wilcox WF, Wasson DI, Kovach J. Development and evaluation of an integrated, reduced-spray program using sterol demethylation inhibitor fungicides for control of primary apple scab. *Plant Dis*. 1992; 76:669-677.
- Sholberg, P.L. and Haag P. (1994). Control of apple powdery mildew (*Podosphaera leucotricha*) in British Columbia by demethylation-inhibiting fungicides. *Canadian Plant Disease Survey* 74:1.
- Azcón-Aguilar C, Barea JM. Arbuscular mycorrhizas and biological control of soil-borne plant pathogens – an overview of the mechanisms involved. *Mycorrhiza* 1996; 6: 457–464.
- Pozo, MJ, Verhage A, García-Andrade J, García JM, Azcón-Aguilar C. Priming Plant Defence Against Pathogens by Arbuscular Mycorrhizal Fungi. Book ID 157289_ChapID 9_Proof# 1. 2008.
- Daft MJ, Nicolson TH. (). Effect of Endogone Mycorrhiza on Plant Growth. III. Influence of Inoculum Concentration on Growth and Infection in Tomato. *New Phytologist*, 2011; 68: (4) pp. 953-961.
- Fortuna P, Citeresi AS, MORINI S, Vitagliano C, Giovannetti M. Influence of arbuscular mycorrhizae and phosphate fertilization on shoot apical growth of micropropagated apple and plum rootstocks. *Tree Physiology*, 1996; 16: 757-763.
- Xu, X.M. and Madden, L.V. Incidence and Density Relationships of Powdery Mildew on Apple. *Epidemiology*, 2002; 92(9): 1005-1014.
- Fortin JA, Becard G, Declerck S, Dalpe Y, St-Arnaud M, Coughland A, Piche Y. Arbuscular

- mycorrhizaa and root-organ cultures. *Canadian Journal of Botany*, 2002; 80: 1-20.
16. Turk MA, Assaf TA, Hameed KM. Al-Tawaha, AM. Significance of Mycorrhizae. *World Journal of Agricultural Sciences*, 2006; 2 (1): 16-20.
 17. Redecker D, Raab P. Phylogeny of the Glomeromycota (arbuscular mycorrhizal fungi): recent developments and new gene markers. *Mycologia*, 2006; 98(6): 885–895.
 18. Wehner J, Antunes PM, Powell JR, Mazukatow J, Rillig MC. Plant pathogen protection by arbuscular mycorrhizas: A role for fungal diversity?. *Pedobiologia*, 2009; 53: 197-201.
 19. Mitre, V, Mitre I, Sestras AF., Sestras RE. New Products against Apple Scab and Powdery Mildew Attack in Organic Apple Production. *Notulae Botanicae Horti Agrobotanici Cluj-Napoca*. 2010; 38 (3): 234-238.
 20. Valiuškaitė, A, Raudonis L, Lanauskas J, Sasnauskas A, Survilienė E. Disease incidence on different cultivars of apple tree for organic growing. *Agronomy Research*, 2009; 7(Special issue I), 536–541.

3/5/2011

Histological Hazards of Chlorpyrifos Usage on Gills and Kidneys of *Tilapia nilotica* and the Role of Vitamin E Supplement in Egypt

Aliaa M. Issa¹, Azza M. Gawish^{*1}, Gehad M. Esmail²

¹Zoology Department, Faculty of Science, Cairo University, Cairo, Egypt

²Central Lab. for Aquaculture Research. Abbasa, Ismailia, Egypt

*azzaGawish@gmail.com

Abstract: Fishes had exhibited a time-honored place in the economical nutrition. Chlorpyrifos is a broad-spectrum organophosphate for agriculture. This study aimed to examine pathological changes on gills and kidneys in Nile tilapia and evaluate the protective role of vitamin E supplementation. Fish were exposed to 0, 2.64 and 5.28 µg/l lorsban and/or vitamin E. Fishes were divided into six groups (control, 2.64 µg/l lorsban, 5.28 µg/l lorsban, vitamin E, vitamin E + 2.64 µg/l lorsban, vitamin E + 5.28 µg/l lorsban treated). Fish behavior was observed. Samples were taken in fixed times for behavioural morphometrical and histopathological studies. The fishes exhibited slowly down swimming, color fading and retardation in opercular movement. The vitamin E + 2.64 µg/l lorsban and vitamin E + 5.28 µg/l lorsban treated fish showed abnormalities in their behavior. Gills and kidney of the 2.64 µg/l lorsban treated group showed several pathological changes throughout the experimental periods. The gills of the vitamin E + 5.28 µg/l lorsban fish treated group showed also pathological changes. We may conclude that the effect of lorsban on the fish is well noticed on their behavioral and histopathological aspects of the gills and kidney tissues and vitamin E may be partially able to ameliorate these effects.

[Aliaa M. Issa, Azza M. Gawish, Gehad M. Esmail **Histological Hazards of Chlorpyrifos Usage on Gills and Kidneys of *Tilapia nilotica* and the Role of Vitamin E Supplement in Egypt**] Life Science Journal. 2011; 8(4):113-123] (ISSN: 1097-8135). <http://www.lifesciencesite.com>.

Key words: *Tilapia nilotica* – Lorsban – Antioxidants – Vitamin

1. Introduction

Pesticides are biologically active chemicals of great value to agriculture (Khogali *et al.*, 2005). Lorsban[®] is a trade name for agricultural-use products of chlorpyrifos (EPA, 2006) a broad-spectrum organophosphate used heavily throughout the world for agriculture and domestic purposes (Ali *et al.*, 2009).

Nile tilapia, *Oreochromis niloticus* Linnaeus (*O. niloticus* L.), is an African fish species (Figueredo and Giani, 2005) of high economic importance which is a benthic omnivorous cichlid commonly found in fish ponds and streams of tropical countries and has much interesting to evolutionary biologists (Martins *et al.*, 2004). Peebua *et al.* (2007) recorded that, the 96-h LC₅₀ values of chlorpyrifos to freshwater fish rainbow trout and fathead minnows were 15 µg/l and 0.58 µg/l, respectively. The toxicity of chlorpyrifos varies from species to species.

Several authors studied the effect of lorsban on different fish species behavior. (Dembele *et al.*, 2000, Adeyemo *et al.*, 2004, Chindah *et al.*, 2004 and Rao, *et al.*, 2005). Histopathological biomarkers in the gills may be valuable as indicators of the general health of the fish and mirror effects of exposure to a variety of anthropogenic pollutants (Wijeyaratne and Pathiratne, 2006). The most common form of gill pathology in juvenile guppies (*Poecilia reticulata*) and (*Oreochromis mossambicus*)

treated with chlorpyrifos were short and irregular appearance of gill lamellae, increase vacuolation of gill tissue, mucous mould of secondary lamellae and complete destruction of many lamellae. The pathological effects on the gills of freshwater fish showed necrosis, abnormalities to gill lamellae, extensive fusions of secondary lamellae and a thick coat of mucus on the gill filaments upon the exposure to chlorpyrifos (De Silva and Samayawardhena 2002, Rao *et al.*, 2003). In addition, hyperemia of the gill filaments, edema, separation of primary gill lamellae, hemorrhage in the blood vessels, clubbing, fusion of adjacent filaments and hyperplasia in secondary gill lamellae in freshwater fish (*Oreochromis mossambicus*) exposed to chlorpyrifos. Hyperplasia with lamellar fusion, telangiectasia, edema with epithelial lifting and desquamation in the gills of Nile tilapia (*Oreochromis niloticus*) and (*Piaractus mesopotamicus*) observed edema in the secondary lamellae, lamellar fusion, and mild and moderate cell hypertrophy and a marked swelling of blood sinuses in the secondary lamellae (telangiectasia), some foci of sub-epithelial edema, lamellar fusion and foci of blood congestion exposed to organophosphate insecticide trichlorfon and glyphosate (Jiraungkoorskul *et al.*, 2003, Guimaraes *et al.*, 2007, Kunjamma *et al.*, 2008 and Mataqueiro *et al.*, 2009).

Kidney plays a vital role in the maintenance of an organism's internal environment, being the key to the regulation of extracellular fluid volume and composition as well as acid–base balance. It is also a target of toxic chemicals, which can disrupt its functions, and cause temporary or permanent derangement of homeostasis. Several authors recorded histopathological changes in the kidney of freshwater fish, *Puntius conchonius* and *Channa punctatus* exposed to organophosphate insecticides diazinon, monocrotophos, dimethoate and elsan, respectively (**Banerjee and Bhattacharya, 1994 and Miller, 2002**). The most histopathological changes in the kidneys of freshwater catfish (*Heteropneustes fossilis*) zebrafish (*Danio rerio*) exposed to organophosphate insecticide chlorpyrifos were shrunken glomeruli, dilated lumina of the renal tubules and vacuolated blood cells in the glomerular tuft declared strong reaction or even destruction, vacuolization, disintegration of epithelia resulting from necrosis and caryolysis in the kidney (**Mataqueiro et al., 2009 and Scheil et al., 2009**).

The purpose of the present work is to determine the half-lethal concentration (96-h LC₅₀) of organophosphate insecticide lorsban to subadults Nile tilapia fish (*O. niloticus* L.) in order to evaluate the effect of its sublethal toxicity on some organs (gills and kidneys) in Nile tilapia as well as the protective role of vitamin E against the different effects of lorsban pesticide.

2. Material and Methods

1-Experimental Fish:

Clinically healthy, subadults Nile tilapia (*O. niloticus* L.) of average body weight (18.09±0.3g) and total body length (10.5±0.06cm) were a kind gift of the Arabian Fish Breeding Company in Abbasa, Sharkia Governorate. Fish were transferred alive to the Central Laboratory for Aquaculture Research (CLAR) according to **Selvi et al. (2005)**. Fish (30 fish per aquarium) were kept in the maintenance glass aquaria (200 liter capacity) for two weeks to acclimatize to the laboratory environment before transferring them to the test glass aquaria.

2- Test Aquaria:

Test glass aquaria (60 liter capacity) were used for holding fish (10 fish per aquarium) throughout the experimental period. Fish were left (**Monteiro et al., 2006**) to discard the metabolic wastes (**Roy and Bhattacharya, 2006**). A continuous aeration was maintained in each aquarium using electric air pumping compressor. Fish were fed twice daily (at 8:00 a.m. and 5:00 p.m.) with pellets of basal control diet (Fish Nutrition Department, Central Laboratory for Aquaculture Research), at a daily feeding rate 3%

of body weight per day. All the aquaria were kept under the same conditions of temperature (27 ±1°C), pH (7.2±0.1), photo period (14 hours light/10 hours' dark) and dissolved oxygen (DO₂: 7.5±0.1mg/l).

3-Diets:

The basal control diet (diet C) was formulated according to **Kim et al. (2003)** from practical ingredients to satisfy all known nutrient requirements of Nile tilapia with adequate levels of vitamin E, { α -tocopheryl acetate in diet (α -TA)} (**NRC, 1993**).

4- Insecticide:

An emulsified concentrate of organophosphate insecticide lorsban (0,0-diethyl O-3,5,6-trichloro-2pyridyl phosphorothioate) with commercial name Chlorzane EC[®] (a.i. chlorpyrifos, 480g/l), a kind gift of the Egyptian Ministry of Agriculture and Land Reclamation was used in the present study (source: TMKafr El-Ziate for pesticide and chemicals Co., Egypt).

5-Vitamin E:

Vitamin E, as α -tocopheryl acetate (α -TA) was purchased from Chemical Industries Development (CID) Company, Al-Haram, Giza, Egypt.

II- Methods

1-Insecticide exposure:

Different concentrations of lorsban insecticide used in the determination of 96-hrLC₅₀ and in the sublethal study were freshly prepared by diluting the commercial emulsified concentrate of lorsban with aged tap water. The solutions were further diluted to obtain the desired experimental concentrations in the test glass aquaria (**Chandrasekara and Pathiratne, 2007**). Every 24 hours, the test water was renewed to maintain water quality (**Monteiro et al., 2006**) and freshly prepared lorsban solutions were added to be maintained at a constant level (**Durmaz et al., 2006**).

2-Morphometric data:

The condition factor (CF) was calculated according to **Teh et al. (2005)**, while hepatosomatic index (HSI) and renal somatic index (RSI) were calculated based on the total body weight (TW), total length (L), total liver (LW) and kidney weights (RW) (**Zha et al., 2007**) as the following equations:

Condition factor (CF)=[TW (g) /L (cm)³]X 100.

Renal somatic index (RSI)=[RW (g)/TW g] X 100.

Where all weights are in grams (g) and lengths are in centimeters (cm)

Histopathological examinations:

Tissues specimens from three fish per treatment were removed and small pieces of several organs (gills and kidneys) were immediately fixed in neutral

buffered formalin 10%, dehydrated in ascending grades of ethanol, embedded in soft paraffin, sectioned at 5µm thickness and stained with hematoxylin and eosin (H&E) Tissue sections were prepared according to **Bancroft and Gamble (2002)**. Condition factor and renosomatic indices were calculated.

Experimental Design:

The determined 96-h LC₅₀ of lorsban insecticide to subadults *O. niloticus* L. was determined and to be 26.4 µg/l. In the sublethal toxicity test, fish were exposed to 2.64 (1/10 LC₅₀) and 5.28µg/l (1/5 LC₅₀) lorsban and/or vitamin E (0 and 450mg/kg dry diet), divided into six groups (control, 2.64 µg/l lorsban, 5.28µg/l lorsban, vitamin E, vitamin E + 2.64µg/l lorsban vitamin E + 5.28µg/l lorsban treated). Fish behavior was observed. Samples were collected at the end of the 1st, 2nd, 3rd and 4th week at fixed time for behavioural and histopathological studies.

3. Results

Subadults Nile tilapia (*Oreochromis niloticus* L.) were divided into six groups, control, 2.64µg/l (1/10 LC₅₀) lorsban, 5.28µg/l (1/5 LC₅₀) lorsban, vitaminE, vitamin E + 2.64µg/l lorsban and vitamin E + 5.28µg/l lorsban. Fish were sacrificed at the end of the 1st, 2nd, 3rd and 4th week.

1- Behavioral Observations:

Control group of subadults Nile tilapia (*Oreochromis niloticus* L.) showed normal behaviour throughout the sublethal toxicity periods; they exhibited normal swimming activity, normal escape reflex, quick response and normal opercular movement and good appetite.

The subadults Nile tilapia (*O. niloticus* L.) exposed to sublethal concentrations (2.64 and 5.28µg/l) of lorsban ($\frac{1}{10}$ LC₅₀ and $\frac{1}{5}$ LC₅₀, respectively) exhibited an immediate very fast behavioral changes even at the low concentration. A slow down swimming behavior, than the control group, then staying motionless close to the water surface with loss of escape reflex were observed. Fish showed a colour fading, and retardation in opercular movement. They also lost their feeding appetite. An increase in skin mucus secretion and its accumulation on the gills were also showed. Vitamin E treated fish were behaviourally normal and had good appetite as the control group. Those treated with vitamin E lorsban showed abnormalities in their behavior similar to that mentioned from lorsban treated fish.

2-Morphometrical results

a-Condition factor (CF):

Condition factor is an index of growth rate (**Chuiko et al., 2007**). The condition factor (mg/cm³) of Nile tilapia (*Oreochromis niloticus* L.) of all treated groups were none significantly changed after the end of the 1st, 2nd and 4th week as compared to the control group. Condition factor recorded at the end of the 3rd week was significantly decreased to in the 5.28µg/l lorsban and vitamin E + 5.28µg/l lorsban treated groups, respectively compared to in the control group (Fig. 21).

The results by the three-way ANOVA revealed that, the lorsban concentrations and time significantly affected the CF. Vitamin E none significantly affected the CF, while the interaction between vitamin E and time significantly (P<0.001) affected the CF.

b-Renosomatic index (RSI):

The renosomatic index (%) of Nile tilapia *Oreochromis niloticus* L. recorded at the end of 1st week was significantly (P<0.05) decreased to (0.236±0.035%) in 5.28µg/l lorsban treated group compared to (0.274± 0.028%) of the control group. At the end of 3rd week, a significant decrease to (0.208±0.015%) in the 5.28µg/l lorsban treated group compared to (0.311±0.025%) of the control group was also recorded (Table, 2 and Fig. 20).

The results of the three-way ANOVA revealed that, the concentrations of lorsban significantly (P<0.001) affected the RSI. The interactions between lorsban concentrations and time, and between vitamin E and time significantly (P<0.01) affected the RSI. The interaction between lorsban concentrations, vitamin E and time significantly (P<0.05) affected.

3-Histopathological studies:

The histopathological alterations of the 2.64µg/l lorsban, 5.28µg/l lorsban, vitaminE, vitamin E+2.64µg/l lorsban and vitamin E+5.28µg/l lorsban Nile tilapia (*Oreochromis niloticus* L.) treated with were demonstrated in the gills and kidneys.

A-Gills:

Gills of control group of Nile tilapia showed a normal structure that persisted through the four weeks of the experimental period (Fig.1).

Gills of the 2.64µg/l lorsban treated group showed several pathological changes throughout the experimental periods. Hemorrhage at the primary lamellae, intraepithelial oedema and lifting up the epithelial cells of secondary lamellae were showed after one week of treatment (Fig.2). At the end of the third week of treatment, epithelial hypertrophy and adhesion of lamellar tips (synechia) hemorrhage at primary lamellae (Fig.3).

Gills of the 5.28µg/l lorsban treated group showed also histopathological changes throughout the

treatment periods. Epithelial hyperplasia of secondary lamellae and sloughing of secondary lamellae epithelial cells were observed at the end of one week of treatment (Fig. 4). Necrosis and destruction of secondary lamellae architecture appeared after three weeks of treatment; the gill arch appeared hemorrhagic with hyalinization of the adductor muscles, deformation of cartilage core and clavate gill shape were observed after three weeks of treatment (Fig. 5). Complete destruction of the gill architecture; marked necrosis of the epithelial cells of the gill lamellae with obliteration of the apical ends of the gills were noticed at the end of the fourth week (Fig.6).

Gills of the vitamin E treated fish showed normal structure thorough the four weeks of the experimental period (Fig.7).

Gills of the vitamin E+2.64 μ g/l lorsban treated group showed several pathological changes throughout the experimental periods. Intraepithelial oedma, congestion of the entire secondary lamellae, epithelial hyperplasia (Fig.8) were observed at the end of the first week of treatment. In addition, pronounced epithelial hyperplasia and hyperplasia of epithelial cells of secondary lamellae with fused area (Fig. 9) was noticed at the third week of the treatment.

The gills of the vitamin E + 5.28 μ g/l lorsban fish treated group showed also pathological changes throughout the experimental periods. Intraepithelial oedema, hyperplasia of epithelial cells of secondary lamellae and lamellar aneurysm were observed after one week of treatment (Fig.10). In addition, hemorrhage at primary lamellae, sloughing of secondary lamellae epithelial cells, necrosis of primary and secondary lamellae (Fig.11) were recorded at the end of the third week of treatment.

B-Kidney:

The kidney of the control group of subadults Nile tilapia (*O. niloticus* L.) showed normal renal tubules (Fig. 12) and glomeruli inside Bowman's

capsules distributed in the renal interstitial hematopoietic tissue.

Kidney of 2.64 μ g/l lorsban treated group showed several pathological changes throughout the experimental periods. Cloudy swelling of epithelial tubule and fragmentation of glomeruli were observed at the end of first week of treatment (Fig.13). In addition to the previous changes, shrinkage of glomeruli and renal tubule with degenerated epithelial and occlusion lumen was recorded after three weeks of treatment (Fig.14). Renal tubule with degenerated epithelia and dilated lumen, brownish pigments and complete destruction of tubules became pronounced at the end of the experiment (Fig. 15).

The kidney of the 5.28 μ g/l lorsban treated group showed shrunken and fragmented glomeruli within thickened Bowmen's capsule membrane; occlusion of luminal renal tubule with eosinophilic granules and complete destruction of tubules architecture were noticed after three weeks of treatment. (Fig.16). After four weeks of treatment showing marked collapse of glomerulus (small arrow), shrunken (star) and fragmented glomeruli (arrow) within thickened Bowmen's capsule membrane (arrow head) and increase of Bowmen's capsule space (Fig. 17).

The kidney of the vitamin the E + 2.64 μ g/l lorsban treated group showed several pathological throughout the experimental periods. Shrunken glomeruli, with appearance of yellow brownish pigments, proliferation of hematopoietic cells and focal necrosis were observed at the end of the experiment (Fig. 18).

Kidney of the vitamin E + 5.28 μ g/l lorsban treated group showed also pathological throughout the experimental periods. A vacuolar degeneration of glomeruli, thickened Bowmen's capsule membrane and renal tubule with degenerated cells and narrowed lumen, with fiber formation around sloughed necrotic renal tubule epithelial cells was recorded after two weeks of treatment (Fig. 19).

Table (1): Condition factor (CF) (g/cm³) of Nile tilapia (*Oreochromis niloticus* L.) daily exposed to the sublethal concentrations of lorsban (0, 2.64 and 5.28 μ g/l) and/or vitamin E (0, 450mg/Kg dry weight diet) for four weeks.

Treatments	Time intervals			
	1 st week	2 nd week	3 rd week	4 th week
Control	1.533±0.14	1.541±0.038	1.555±0.049	1.564±0.032
2.64 μ g/l lorsban	1.831±0.058	1.41±0.037	1.434±0.036	1.378±0.067
5.28 μ g/l lorsban	1.869±0.044	1.49± 0.057	1.368±0.045*	1.462±0.054
Vit. E	1.541±0.087	1.549±0.094	1.625±0.068	1.668±0.055
2.64 μ g/l lorsban + Vit. E	1.595±0.07	1.542±0.052	1.525±0.035	1.555±0.11
5.28 μ g/l lorsban + Vit. E	1.534±0.053	1.452± 0.07	1.387±0.024*	1.41±0.032

Table (2): Renosomatic index (RSI) (%) of Nile tilapia (*Oreochromis niloticus* L.) daily exposed to the sublethal concentrations of lorsban (0, 2.64 and 5.28 μ g/l) and/or vitamin E (0, 450mg/Kg dry weight diet) for four weeks.

Treatments	Time intervals			
	1 st week	2 nd week	3 rd week	4 th week
Control	0.274 \pm 0.028	0.295 \pm 0.017	0.311 \pm 0.025	0.292 \pm 0.014
2.64 μ g/l lorsban	0.266 \pm 0.018	0.274 \pm 0.021	0.279 \pm 0.038	0.264 \pm 0.034
5.28 μ g/l lorsban	0.236 \pm 0.035*	0.239 \pm 0.014	0.208 \pm 0.015*	0.331 \pm 0.028
Vit. E	0.29 \pm 0.034	0.302 \pm 0.019	0.304 \pm 0.018	0.313 \pm 0.025
2.64 μ g/l lorsban + Vit.E	0.274 \pm 0.021	0.302 \pm 0.018	0.252 \pm 0.023	0.248 \pm 0.015
5.28 μ g/l lorsban + Vit.E	0.260 \pm 0.054	0.2394 \pm 0.018	0.234 \pm 0.026	0.227 \pm 0.012

Data are represented as means \pm standard errors of 5 specimens.

*Significant ($P < 0.05$) change compared to the control group of each time interval. Vit. E = Vitamin E

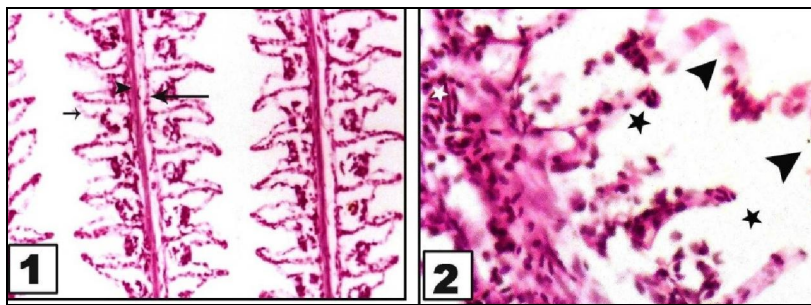

Fig. 1: Photomorphograph of the gill section of control Nile tilapia (*Oreochromis niloticus* L.) showing the primary lamellae (arrow), secondary lamellae (arrow head) and cartilage core (star). H&E. 200 X.

Fig. 2: Photomorphograph of the gill section of Nile tilapia (*Oreochromis niloticus* L.) treated with 2.64 μ g/l lorsban for one week showing hemorrhage at primary lamellae (white star), intraepithelial oedema (black star), hypertrophy (arrow) and lifting up (arrow head) of epithelial cells of secondary lamellae. H&E. X 400.

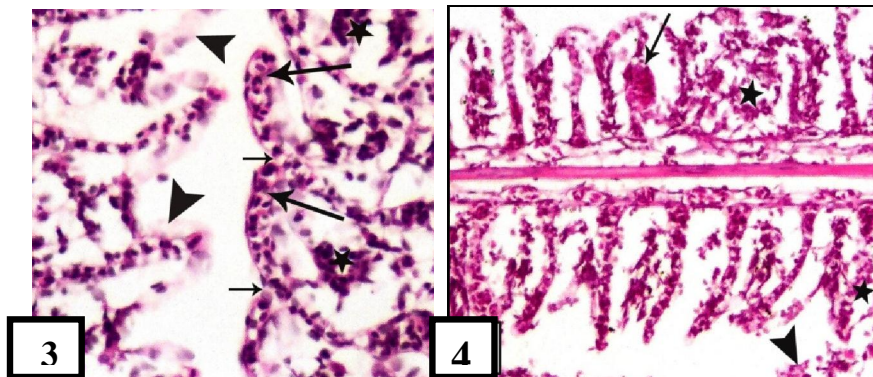

Fig. 3: Photomorphograph of the gill section of Nile tilapia (*Oreochromis niloticus* L.) treated with 2.64 μ g/l lorsban for three weeks showing hypertrophy (arrow head) and hyperplasia (star) of epithelial secondary lamellae, adhesion of lamellar tips synechiae (small arrow) and congestion in the entire secondary lamellae (arrow) H&E. X 200.

Fig. 4: Photomorphograph of the gill section of Nile tilapia (*Oreochromis niloticus* L.) treated with 5.28 μ g/l lorsban for one week showing epithelial hyperplasia (star) and sloughing of secondary lamellae epithelial cells (arrow head) and lamellar aneurysm (arrow). H & E. X 200.

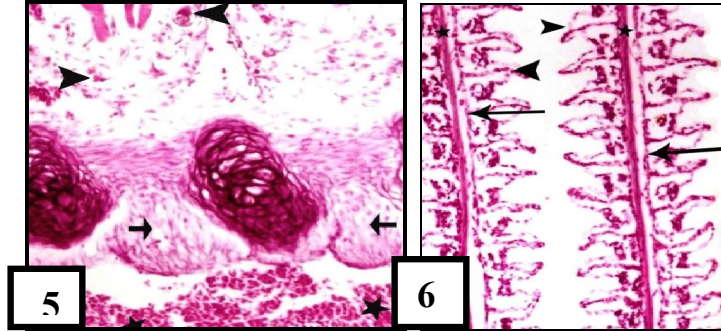

Fig. 5: Photomorphograph of the gill section of Nile tilapia (*Oreochromis niloticus L.*) treated with 5.28µg/l lorsban for three weeks showing hemorrhage (star), oedema at the gill arch (small arrow) with leucocytic infiltration (arrow head) and hyalinization of the adductor muscles (arrow), H & E. X 200.

Fig. 6: Photomorphograph of the gill section of Nile tilapia (*Oreochromis niloticus L.*) treated with 5.28µg/l lorsban for four weeks showing deformation of the cartilage core (star), epithelial hyperplasia (double arrows), necrosis of the epithelial cells of primary (small arrow) and secondary (arrow) lamellae and complete destruction of the gill; obliteration of normal lamellae architecture affecting the apical distal ends of the gill (arrow head). H & E. X 200.

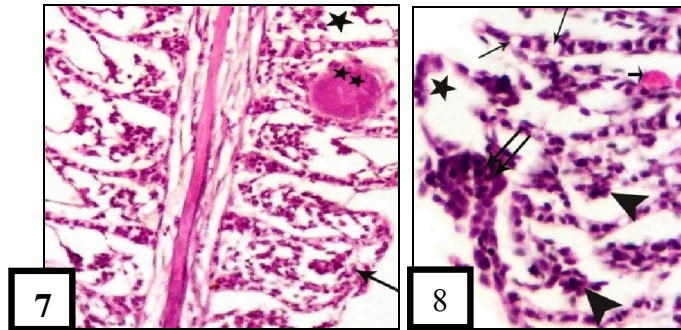

Fig. 7: Photomorphograph of the gill section of Nile tilapia (*Oreochromis niloticus L.*) treated with vitamin E for one week showing the primary lamellae (arrow), secondary lamellae (arrow head) and cartilage core (star). H&E. 200 X.

Fig. 8: Photomorphograph of the gill section of Nile tilapia (*Oreochromis niloticus L.*), treated with vitamin E + 2.64µg/l lorsban for one week showing intraepithelial oedma (star), congestion of entire secondary lamellae (arrow head), epithelial hyperplasia (arrow). H & E. X 400.

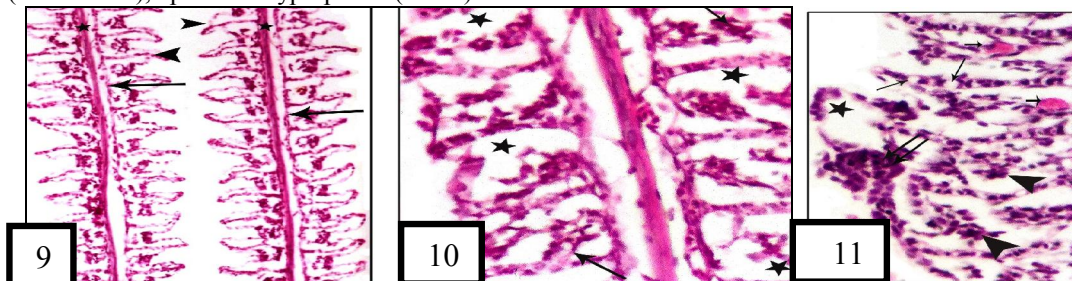

Fig. 9: Photomorphograph of the gill section of Nile tilapia (*Oreochromis niloticus L.*), treated with vitamin E + 2.64µg/l lorsban for three weeks showing intraepithelial oedema (star), vacuolar degeneration of pillar cells (arrow), marked epithelial hyperplasia (arrow head) with leucocytic infiltration (small arrow) and lamellar synechiae (double arrow). H& E. X 400.

Fig. 10: Photomorphograph of the gill section of Nile tilapia (*Oreochromis niloticus L.*), treated with vitamin E + 5.28µg/l lorsban for one week showing intraepithelial oedema (star), hyperplasia of epithelial cells of secondary lamellae (arrow) and aneurysm (double stars). H& E. X 200.

Fig. 11: Photomorphograph of the gill section of Nile tilapia (*Oreochromis niloticus L.*), treated with vitamin E + 5.28µg/l lorsban for three weeks showing intraepithelial oedema (star), lifting of secondary lamellae epithelial cells (arrow head) and quite frequent epithelial hyperplasia (arrow) forming fused area. H & E. X 200.

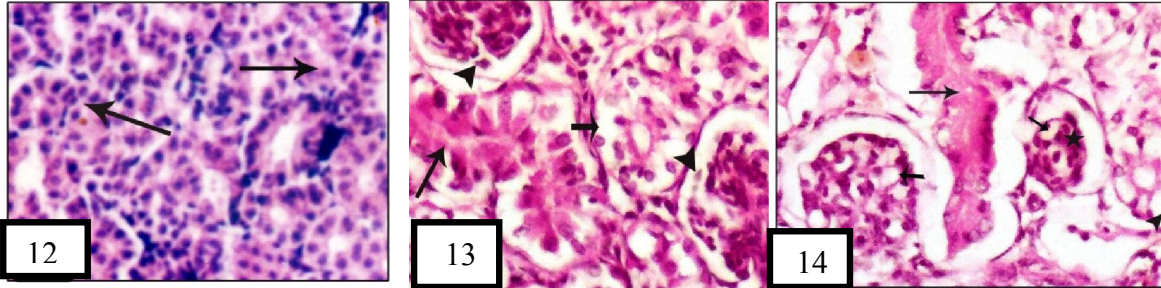

Fig. 12: Photomorphograph of the kidney section of control Nile tilapia (*Oreochromis niloticus* L.) showing normal architecture; renal tubule (arrow). H & E. X 200.

Fig. 13: Photomorphograph of the kidney section of Nile tilapia *Oreochromis niloticus* treated with 2.64 μ g/l lorsban for one week showing cloudy swelling of epithelial cells of renal tubule (small arrow), renal tubule with dilated lumen (star) and occlusion lumen (star) and fragmentation of glomeruli (arrow head). H & E. X 400.

Fig. 14: Photomorphograph of the kidney section of Nile tilapia (*Oreochromis niloticus* L.) treated with 2.64 μ g/l lorsban for three weeks showing shrinkage (star) and vacuolar degeneration of glomeruli (small arrow), cloudy swelling of epithelial cell of renal tubule with narrowing lumen (arrow head), renal tubule with degenerated epithelia and occlusion lumen (arrow). H & E. X 400.

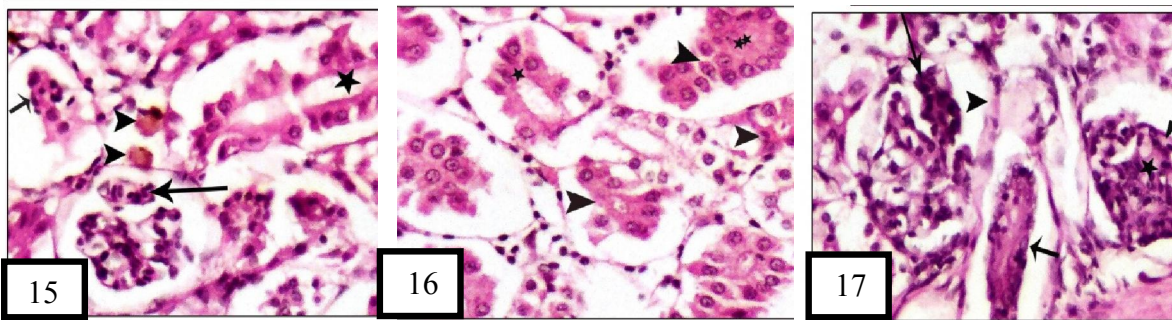

Fig. 15: Photomorphograph of the kidney section of Nile tilapia (*Oreochromis niloticus* L.) treated with 2.64 μ g/l lorsban for four weeks showing renal tubule with degenerated epithelial cells and dilated lumen (star), complete destruction of tubule architecture (small arrow), fragmentation of glomerulus (arrow) and brownish pigments (arrow head). H & E. X 400.

Fig. 16: Photomorphograph of the kidney section of Nile tilapia (*Oreochromis niloticus* L.) treated with 5.28 μ g/l lorsban for three weeks showing degenerated tubules obstructed with eosinophilic granules (arrow head), with complete occlusion lumen (double stars) and with dilated lumen (star). H & E. X 400.

Fig. 17: Photomorphograph of the kidney section of Nile tilapia (*Oreochromis niloticus* L.) treated with 5.28 μ g/l lorsban for four weeks showing marked collapse of glomerulus (small arrow), shrunken (star) and fragmented glomeruli (arrow) within thickened Bowmen's capsule membrane (arrow head) and increase of Bowmen's capsule space (double heads arrow). H & E. X 400.

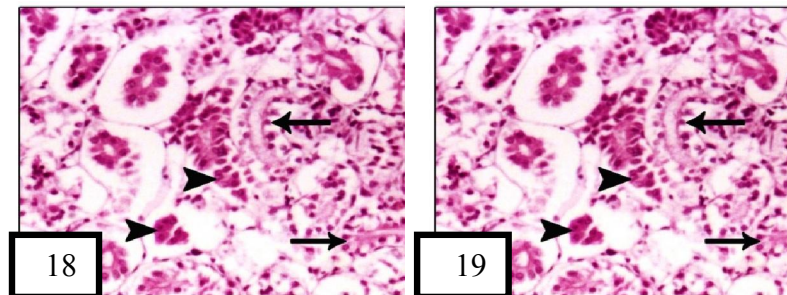

Fig. 18: Photomorphograph of the kidney section of Nile tilapia (*Oreochromis niloticus* L.) treated with vitamin E + 2.64 μ g/l lorsban for four weeks showing yellow brownish pigments (arrow head), degenerated renal tubule with complete occlusion lumen (small arrow), proliferation of hematopoietic cells (arrow) and focal necrosis (star). H & E. X 400.

Fig. 19: Photomorphograph of the kidney section of Nile tilapia (*Oreochromis niloticus* L.) treated with vitamin E + 5.28 μ g/l lorsban for two weeks showing marked degeneration of epithelial tubule (arrow) and destruction of renal tubule (arrow head). H & E. X 200.

4. Discussion

Chlorpyrifos forms the active ingredient in Dursban™ and Lorsban™ insecticides (Kienle *et al.*, 2009). Acute toxicity tests with lorsban on different fish species, at different life stages and under different environmental conditions were studied (Karen *et al.*, 1998 and 2001).

Behaviour integrates responses to internal (physiological) and external (environmental, social) factors represent a sensitive method to detect the effects of contaminants (Dell'Omo, 2002). In the present study, Nile tilapia (*O. niloticus* L.) treated with lorsban exhibited behavioral changes; such as slow down, swimming and a less general activity than the control group, as well as staying motionless close to the water surface and losses of escape reflex. Fish color fading, retardation in opercula movement were also noticed. Moreover, loss of the fish (feeding) appetite, increase skin mucus secretion and accumulation on the gills were observed.

Vitamin E was not able to prevent these behavioural changes in lorsban treated fish. Increased frequency of fish surfacing may be due to the deficiency in respiratory exchange, as a result of severe disruption of gill membranes and deposition of mucus on gills (Velmurugan *et al.*, 2007). This was histopathologically confirmed in the present study by the noticed marked gill lesions. The mucus deposition on the gills and damage caused to gill lamellae by the toxicant would reduce gaseous exchange across them (Al-Ghanim *et al.*, 2008). The decline in the opercular movement observed in the present study is in agreement with Chindah *et al.* (2004), who exposed another tilapia species (*Tilapia guineensis*) to chlorpyrifos. This could be explained by an adaptive response of the fish to minimize the intake of toxicant by reducing the frequency of opercular beating (Pandey *et al.*, 2008).

The observed increase of mucus secretion and accumulation on skin and gills recorded by (Rao *et al.*, 2005). Histopathologically this was by the proliferation of mucus cells and epithelial hyperplasia of gills. This could be explained by the probability of coating the body so as to reduce contact with the toxic environment and get relief from the pollutant irritation (Al-Ghanim *et al.*, 2008).

The loss of fish appetite was observed in the present study. This may be due to a decrease in the amount of food consumed in (*Abramis brama*) fish and attributed that to the cholinergic system in fish brain and the inhibition of acetylcholine esterase enzyme the feeding behavior in fish (Pathiratne, 1999).

Histopathological results of the present study indicated that, gills of Nile tilapia (*O. niloticus* L.)

were the primary target tissue affected by lorsban and vitamin E not able to prevent these effects. Many lesions in the gills were recorded in the present study as hemorrhage at the primary lamellae, intraepithelial edema with lifting up and sloughing of epithelial cells of the secondary lamellae. Hypertrophy and hyperplasia of the epithelial cells of the secondary lamellae, vacuolar degeneration of pillar cells and lamellar aneurysms were also noticed. At the end of the experiment, necrosis with leucocytic infiltration and deformities of cartilage were obtained.

The different concentrations of lorsban used in the present study as well as the different exposure periods showed different degrees of pathological changes. Similar results were recorded in the freshwater fish (*Puntius gonionotus*), *Oreochromis niloticus*), (*Gambusia affinis*) and (*Corydoras paleatus*) exposed to pesticides paraquat, and dimethoate (Elezaby *et al.*, 2001, Cengiz and Ünlü, 2003, Fanta *et al.*, 2003 and Jiraungkoorskul *et al.*, 2003) respectively.

In Sri Lanka, gills of (*Rasbora caverii*) collected from canals near rice fields, covering pesticide application periods during rice cultivation season showed also similar changes (De Silva and Samayawardhena, 2002; Wijeyaratne and Pathiratne, 2006) and juvenile guppies (*Poecilia reticulata* Peters) and (*Oreochromis mossambicus*) exposed to sublethal concentration of chlorpyrifos (Rao *et al.*, 2003 and Kunjamma *et al.*, 2008).

The histopathological results observed in present study as gill epithelial necrosis was considered a direct response of lorsban, while excessive mucus secretion, the epithelium lifting up, lamellar fusion and clavate lamella were defense responses (Richmonds, and Dutta, 1989). Epithelium lifting increases the distance through which the toxicant has to travel to reach the blood stream and lamellar fusion could be protective as it diminishes the amount of vulnerable gill surface area (Ortiz *et al.*, 2003). These epithelial lifting reactions could result in dysfunctional or even non-functional gills, and eventually asphyxiate the fish. This epithelial lifting could be due to edema following the exposure to the used chemical of the lamellar tissue pollutant (Morrison *et al.*, 2001).

Roberts (2001) recorded that, if the irritant stimulus is more severe, it will have three different responses depending on the toxicant; these are lamellar edema; lamellar hyperplasia; and lamellar fusion. In the present study, the epithelial hyperplasia could be a consequence of the epithelial detachment (Machado and Fanta, 2003) and lamellar fusion could be a result of both hyperplasia of epithelial cells and the adhesion of the lamellar tips, seen as synechiae (Morrison *et al.*, 2001).

Lesions associated with the disturbance of blood flow in the gills (lamellar aneurysm) were prevalent in the present study and could be due to the effect of lorsban. According to **Campagna et al. (2007)** hyperplasia, total fusion of the secondary lamellae, dilation of capillaries of secondary lamellae and lifting up the gill epithelium in the respiratory area observed in the present study, were considered to be of the first degree of gill lesions while lamellar aneurysms. It was that extensive lamellar aneurysm (telagiectasis) takes considerably longer time to resolve than the hyperplastic lesions of the gill (**Roberts, 2001**).

The appearance of leucocytic infiltration in the gills of the present study was also noticed by **Neskovic et al. (1996)** in carp fish *Cyprinus carpio* treated with glyphosate. They explained that, the leucocytic infiltration in the gills supports the inflammatory reaction indicated by hyperplasia in the freshwater environment. Thus, fish have to fight constantly against the osmotic influx of water that occurs across the gills during respiration.

The kidney plays the major role in this fight, producing large quantities of diluted urine. Although the kidney does not possess high levels of xenobiotic metabolizing enzymes as does the liver, many of the enzymatic reactions occurring in the liver have been shown to occur in the kidney (**Mohssen, 2001**). It receives the bulk of the post branchial blood flow; kidney tissue is of importance in the detoxification and elimination of aquatic contaminants in fish (**Durmaz et al., 2006**).

The kidney appears to be particularly sensitive to a variety of toxins due to the high renal blood flow, the ability to concentrate substances, and the biotransformation of the parent compound to a toxic metabolite (**Mohssen, 2001**).

The present work revealed that, Nile tilapia fish (*O. niloticus*) treated with lorsban showed several histological alterations in the kidney, such as vacuolar degeneration of glomerular tuft, shrinkage of some glomeruli and dilatation of others, increase Bowman's capsule space. Moreover, cloudy swelling of some epithelial tubules, degeneration of others, and dilatation of tubules lumens and obstruction of others were also observed. At the end of the experiment, focal necrosis with leucocytic infiltration was noticed. These results are in agreement with the changes in the kidney of zebrafish (*Danio rerio*), exposed to sublethal concentration of chlorpyrifos (**Scheil et al., 2009**) and on freshwater fish (*Piaractus mesopotamicus*) exposed to organophosphate insecticide (**Mataqueiro et al., 2009**). The shrinkage in renal corpuscles clearly indicates that treated fish adopt some other routes of nitrogen excretion while the dilation of the renal corpuscles may be due to an increase in the filtration rate and consequently in urine

volume, which may be a mechanism used by fish to overcome the toxic effect of the pesticide (**Roy and Bhattacharya, 2006**).

The decreases in the tubular lumen may be due to the cloudy swelling of the epithelial cells of the renal tubules, which could be a reversible change. Also, the dilation in the tubules lumen may be due to the marked decrease in the length of the epithelial cells as a result of epithelial tubules degeneration while in the present study, the recognized homogenous eosinophilic deposits within tubular lumen could be attributed to the protein leakage into the filtrate due to the glomerular disease (**Roberts, 2001**).

Lorsban used in the present research caused some histopathological changes in the kidney tissues and the used vitamin E was not able to prevent these changes. Organophosphate insecticide chlorpyrifos caused kidney damage, and a combination of vitamins E and C reduced partially this damage. On a relative basis, lorsban appears to be capable of producing a wider spectrum of significant histopathologic impairments in fish with even sub lethal concentrations and should be categorized as an important pollutant of the aquatic environment (**Oncu et al., 2002**).

The morphometric study included condition factor and renosomatic indices. The condition factor (mg/cm^3) of Nile tilapia (*O. niloticus* L.) of all treated groups showed very minor change; significant decrease in the condition factor of $5.28\mu\text{g}/\text{l}$ lorsban at the end of the 3rd week compared to the control group and vitamin E couldn't prevent this decrease. The significant lower condition factor was recorded by **Teh et al. (2005)** in (*Pogonichthys macrolepidotus*) exposed to sublethal concentrations of diazinon. The few changes in condition factor through the present experimental periods could be attributed to that, this factor could not be enough a sensitive biomarker to measure the environmental stress in natural environments (**Wijeyaratne and Pathiratne, 2006**).

The recorded non significant effect of vitamin E on the condition factor throughout the experimental periods was also recorded in the freshwater fish rainbow trout (*Oncorhynchus mykiss*) (**Chaiyapechara et al., 2003**). This indicates that, the addition of α -tocopherol to the diet did not significantly alter the palatability of the diet, its nutrient content, and the caloric values (**Al-Juary et al., 2006**).

Tissue somatic indices, such as the renosomatic index are general measurement of the overall condition of fish or growth status of a specific tissue (**West, 1990**). The minor changes was recorded in the present study in the renosomatic index of fish treated with lorsban. A significant decrease in the

renosomal index of fish treated with the high sublethal concentration of lorsban was recorded at the end of the 1st and 3rd weeks. While non significant changes were observed in the vitamin E and the vitamin E + lorsban treated groups throughout the experimental periods. Absolute kidney weight and relative kidney weight were decreased in methyl parathion treated groups after 4 and 7 weeks of treatment, while did not show any significant changes in vitamin E and C treated groups during experimental periods compared to the control group (Kalender, 2007). We can concluded from the present study that the toxic effect of lorsban on fish, is clear on their behavioral and histopathological aspects of gills and kidney tissues while vitamin E has a fair amelioration effects on these parameters.

Corresponding author

Azza M. Gawish

Zoology Department, Faculty of Science, Cairo

University, Cairo, Egypt

azzaGawish@ymail.com

References

- Adeyemo OK, Akintoye OA, and Oghi ML, 2004. Acute toxicity of chlorpyrifos (dursban®) to *Clarias gariepinus* juveniles. *Tropical Veterinarian Trop.*, 22 (1): 7-11.
- Al-Ghanim K, Al-Balawi H, Al-Akel A, Al-Misned F, Ahmad Z and Annazri H., 2008. Ethological response and haematological and biochemical profiles of carp (*Cyprinus carpio*) exposed to trichlorfon. *J. Food Agric. Environ.*, 6 : 4 7 3 – 4 7 9.
- Ali D, Nagpurea N, Kumar S, Kumar R, Kushwahaa B and Lakraa W., 2009. Assessment of genotoxic and mutagenic effects of chlorpyrifos in freshwater fish *Channa punctatus* (Bloch) using micronucleus assay and alkaline single-cell gel electrophoresis. *Food Chem. Toxicol.*, 47: 650-656.
- Al-Juary AA, Al-Awwad KH and Al-Torahi FA. , 2006. The effect of α -tocopherol on cholesterol and lipoproteins levels in rats. *Pakistan J. of Nut.* , 5 (4): 337-340.
- Bancroft J and Gamble M. , 2002. "Theory and Practic of Histology Techniques." 5th (ed.), Churchill Livingstone, London..
- Campagna A, Eler M, Fracácio R, Rodrigues B and Verani N. , 2007. The toxic potential of aldrin and heptachlor on *Danio rerio* juveniles (Cypriniformes, Cyprinidae). *Ecotoxicology*, 16: 289–298.
- Cengiz E and Ünlü E. , 2003. Histopathology of gills in mosquito fish, *Gambusia affinis* after long-term exposure to sub-lethal concentrations of malathion. *J. Environ. Sci. Health B*, 38 (5): 581-589.
- Chandrasekara L and Pathiratne A. , 2007. Body size-related differences in the inhibition of brain acetylcholinesterase activity in juvenile Nile tilapia (*Oreochromis niloticus*) by chlorpyrifos and carbosulfan. *Ecotoxicol. Environ. Saf.* , 67 (1):109-119.
- Chindah A, Sikoki F and Vincent-Akpu, 2004. Changes in haematological characteristics of a bony fish, *Tilapia guineensis* (Bleeker, 1862), exposed to common pesticides in the Niger Delta Wetland, Nigeria. *Ghana J. Agric. Sci.*; 37: 59-67.
- Claiborne JB, Edwards SL, Morrison-Shetlar AI. , 2002. Acid-base regulation in fishes: cellular and molecular mechanisms. *J. Exp. Zool.*; 293: 302-319.
- Dell'Omo G 2002. "Behavioural Ecotoxicology". Wiley, Chichester.
- Dembele K, Haubruge E and Gaspar C. ,2000. Concentration effects of selected insecticides on brain acetylcholinesterase in the common carp (*Cyprinus carpio* L.), *Ecotoxicol. Environ. Saf.*; 45: 49–54.
- De Silva PM and Samayawardhena LA. , 2002. Low concentrations of lorsban in water result in far reaching behavioral and histological effects in early stages in guppy. *Ecotoxicol. Environ. Saf.*, 53: 248-254.
- Durmaz H, Sevgiler Y, and Üner N. , 2006. Tissue-specific antioxidative and neurotoxic responses to diazinon in *Oreochromis niloticus*. *Pestic. Biochem. and Physiol.*; 84: 215–226.
- Elezaby M, El-Serafy S, Heckmann R, Sharf-Eldeen K and Seddek M. , 2001. Effect of some toxicants on the fresh water fish *Oreochromis niloticus*. *J. Egypt Ger. Soc. Zool.*, 36: 407-344.
- EPA, 2006. Interim Reregistration Eligibility Decision for Chlorpyrifos. U. S. Environmental Protection Agency, Office of Prevention, Pesticides and Toxic Substances, Washington, D.C, USA.
- Fanta E, Rios F, Romao S, Vianna A and Freiberger S. , 2003. Histopathology of the fish *Corydoras paleatus* contaminated with sub-lethal levels of organophosphorus in water and food. *Ecotoxicol. Environ. Safe.*; 54:119–130.
- Figueredo C and Giani A. , 2005. Ecological interactions between Nile tilapia (*Oreochromis niloticus*, L.) and the phytoplanktonic community of the Furnas Reservoir (Brazil). *Freshwater Biology*, 50: 1391–1403.
- Giari L, Simoni E, Manera M and Dezfuli B 2008. Histocytological responses of *Dicentrarchus labrax* (L.) following mercury exposure. *Ecotoxicol. Environ. Saf.*; 70: 400–410.
- Guimaraes A, Silva de Assis H and Boeger W. , 2007. The effect of trichlorfon on acetylcholinesterase activity and histopathology of cultivated fish *Oreochromis niloticus*. *Ecotoxicol. Environ. Saf.*; 68 (1): 57-62.
- Jiraungkoorskul W, Upatham E, Kruatrachue M, Sahaphong S, Vichasri-Grams S and Pokethitiyook P. , 2003. Biochemical and histopathological effects of glyphosate herbicide on Nile tilapia (*Oreochromis niloticus*). *Environ. Toxicol.*; 18 (4): 260–267.
- Kalender S, Kalender Y, Durak D, Ogutcu A, Uzunhisarcikli M, Cevrimli B and Yildirim M. , 2007. Methyl parathion induced nephrotoxicity in male rats and protective role of vitamins C and E. *Pestic. Biochem. Physiol.*; 88: 213–218.
- Karen D, Draughn R, Fultin M and Ross P. , 1998. Bone strength and acetylcholinesterase inhibition as endpoints in chlorpyrifos toxicity to *Fundulus heteroclitus*. *Pestic. Biochem. Physiol.*; 60: 167-175.
- Karen D J, Klaine S J and Ross P E. , 2001. Further considerations of the skeletal system as a biomarker of episodic chlorpyrifos exposure. *Aquat. Toxicol.*; 52: 285-296.
- Khogali F, Sheikh J, Abdel Rahman S, Rahim A and Maha H. , 2005. Histopathological and Hematological Effects of Dimethoate 40EC on Some Organs of Albino Mice. *J. King Saud Univ.*, 18: Science; (2): 73-87.
- Kienle C, Köhler H-R and Gerhardt A, 2009. Behavioural and developmental toxicity of chlorpyrifos and nickel chloride to zebrafish (*Danio rerio*) embryos and larvae *Ecotoxicol. Environ. Saf.*; 72:1740–1747.
- Kim K, Wang X Choi S Park G, Koo J and Bai S. , 2003. No synergistic effects by the dietary supplementation of ascorbic acid, α -tocopheryl acetate and selenium on the growth performance and challenge test of *Edwardsiella tarda* in fingerling Nile tilapia, *Oreochromis niloticus* L. *Aquac. Res.*; 34: 1053-1058.
- Kunjamma A, Philip B, Bhanu S and Jose J. , 2008. Histopathological effects on *Oreochromis mossambicus* (Tilapia) exposed to chlorpyrifos. *J E R D.*; 2 (4): 553-559.

29. Machado M and Fanta E. , 2003. Effects of the organophorous methyl parathion on the branchial epithelium of a freshwater fish *Metynnis eossevelti*. Braz. Arch. Boil. Techn.; 46(3): 361-372.
30. Martins C, Oliveira C, Wasko A and Wright J., 2004. Physical mapping of the Nile tilapia (*Oreochromis niloticus*) genome by fluorescent in situ hybridization of repetitive DNAs to metaphase chromosomes—a review. Aquaculture; 231 (1-4): 37-49.
31. Malins D, Stegeman J, Anderson J, Johnson P, Gold J and Anderson K., 2004. Structural Changes in Gill DNA Reveal the Effects of Contaminants on Puget Sound Fish. Environ. Health Persp.; 112 (5): 99-105.
32. Mataqueiro M, Nakaghi S, de Souza J, da Cruz C, de Oliveira G and Urbinati E. , 2009. Histopathological changes in the gill, liver and kidney of pacu (*Piaractus mesopotamicus*, Holmberg, 1887) exposed to various concentrations of trichlorfon. J. Appl. Ichthyol.; 25: 124–127.
33. Miller DS. ,2002. Xenobiotic export pumps, endothelin signalling, and tubular nephrotoxicants: a case of molecular hijacking. J. Biochem. Mol. Toxicol.; 16: 121–127.
34. Mohssen M. , 2001. Biochemical and histopathological changes in serum creatinine and kidney induced by inhalation of thimet (phorate) in male swiss albino mouse, *Mus musculus*. Environ. Res.; 87 A: 31-36.
35. Monteiro DA, de Almeida JA, Rantin FT and Kalinin AL. , 2006. Oxidative stress biomarkers in the freshwater characid fish, *Brycon cephalus*, exposed to organophosphorus insecticide folisuper600 (methyl parathion). Comp. Biochem. Physiol., C143 (2): 141-149.
36. Morrison R, Nowak B and Carson J., 2001. The histopathological effects of a levamisole-adjuvanted *Vibrio anguillarum* vaccine on Atlantic salmon (*Salmo salar* L.). Aquaculture; 195: 23-33.
37. Neskovic N, Poleksic V, Elezovic I, Karan V and Budimir M. , 1996. Biochemical and histopathological effects of glyphosate on carp, *Cyprinus carpio* L. Bull. Environ. Contam. Toxicol.; 56: 295-302.
38. Oncu M, Gultekin F, Karaz E, Altuntas I and Delibas N. , 2002. Nephrotoxicity in rats induced by chlorpyrifos-ethyl and ameliorating effects of antioxidants. Hum. Exp. Toxicol.; 21: 223–230.
39. Ortiz J, De Canales M, and Sarasquete C., 2003. Histopathological changes induced by lindane (γ -HCH) in various organs of fishes. Sci. Mar., 67 (1): 53–61.
40. Pandey R K, Singh R N and Das V K., 2008. Effect of temperature on mortality and behavioural responses in freshwater catfish, *Heteropneustes fossilis* (Bloch) Exposed to Dimethoate. Global J. Environ. Res.; 2 (3): 126-132.
41. Pathiratne A and Athauda P., 1999. Toxicity of chlorpyrifos and dimethoate to fingerlings of Nile tilapia, *Oreochromis niloticus*: cholinesterase inhibition. Sri Lanka J. Aquat. Sci.; 3: 77-87.
42. Peebua P, Kosiyachinda P, Pokethitiyook P and Kruatrachue M. , 2007. Evaluation of alachlor herbicide impacts on Nile tilapia (*Oreochromis niloticus*) using biochemical biomarkers. Bull. Environ. Contam. Toxicol.; 78 (2): 138-141.
43. Pavlov DD, Chuiko GM, Gerassimov YV and Tonkopyi VD. , 1992. Feeding behavior and brain acetylcholinesterase in *Bream abramis brama* as affected by DDVP, an organophosphorous insecticide. Comp. Biochem. Physiol.; C 103: 563–568.
44. Rao J, Begum G, Pallela R, Usman P and Rao R. , 2005. Changes in behavior and brain acetylcholinesterase activity in mosquito fish, *Gambusia affinis* in Response to the sub-lethal exposure to chlorpyrifos. Int. J. Environ. Res. Public Health; 2 (3): 478-483.
45. Roberts R J 2001. Fish Pathology. 3rd (Ed.), W.B. Saunders, New York.
46. Roy S and Bhattacharya S., 2006. Arsenic – induced histopathology and synthesis of stress proteins in liver and kidney of *Channa punctatus*. Ecotoxicol. Environ. Saf.; 65: 218-229.
47. Scheil V, Zürn A, Köhler H and Triebkorn R. , 2009. Embryo development, stress protein (Hsp70) responses, and histopathology in Zebrafish (*Danio rerio*) following exposure to nickel chloride, chlorpyrifos, and binary mixtures of them. Environ. Toxicol.; 25 (1): 83 – 93.
48. Selvi M, Sarikaya R, Erko F and Kocak O. 2005. Investigation of acute toxicity of chlorpyrifos-methyl on guppy *Poecilia reticulata*. Chemosphere; 60: 93-96.
49. Teh S, Deng D, Werner I, Teh F and Hung S, 2005. Sub-lethal toxicity of orchard storm water runoff in Sacramento splittail (*Pogonichthys macrolepidotus*) larvae. Mar. Environ. Res.; 59: 203-216.
50. Tkatcheva V, Hyvärinen H, Kukkonen J, Ryzhkov L and Holopainen I. , 2004. Toxic effects of mining effluents on fish gills in a subarctic lake system in NW Russia. Ecotoxicol. Environ. Saf.; 57: 278–289.
51. Velmurugan B, Selvanayagam M, Cengiz E, Uysal E. ,2008. Levels of transaminases, alkaline phosphatase, and protein in tissues of *Clarias gariepinus* fingerlings exposed to sub-lethal concentrations of cadmium chloride. Environ., Toxicol.; 23: 672–678.
52. West G. , 1990. Methods of assessing ovarian development in fishes- a review. Aust. J. Mar. Freshwater Res.; 41: 199-222.
53. Wijeyaratne W and Pathiratne A. , 2006. Acetylcholinesterase inhibition and gill lesions in *Rasbora caverii*, an indigenous fish inhabiting rice field associated water bodies in Sri Lanka. Ecotoxicology, 15: 609–619.
54. Zha J, Wang Z, Wang N and Ingersoll C., 2007. Histological alteration and vitellogenin induction in adult rare minnow (*Gobiocypris rarus*) after exposure to ethynylestradiol and nonylphenol. Chemosphere, 66: 488-495.

9/22/2011

Glaucoma Treatment with the Extract of Astragalus Membranaceus in Rats Experimental Model

Chi-Ting Horng^{1,2}, Ming-Liang Tsai³, Jeng-Chuan Shiang⁴, Shang-Tao Chien⁵, Chiang-Hsiang Lu⁶,
Tsung-Hsung Chang⁶, Fu-An Chen^{2,*}

¹ Department of Ophthalmology, Kaohsiung Armed Forces General Hospital, Kaohsiung, Taiwan, ROC

² Department of Pharmacy & Graduate Institute of Pharmaceutical Technology, Tajen University, Pingtung, Taiwan, ROC.

³ Department of Ophthalmology, Tri-Services General Hospital, Taipei, Taiwan, ROC.

⁴ Department of Medicine, Kaohsiung Armed Forces General Hospital, Kaohsiung, Taiwan, ROC

⁵ Department of Pathology, Kaohsiung Armed Forces General Hospital, Kaohsiung, Taiwan, ROC

⁶ Department of Surgery, Kaohsiung Armed Forces General Hospital, Kaohsiung, Taiwan, ROC

h56041@gmail.com

Abstract: Glaucoma is one of the world's leading causes of blindness. Astragalus membranaceus is a well-known traditional Chinese herbal medicine widely used for a long time. The aim of our study is to evaluate the activity of lowering intraocular pressure through the use of Astragalus membranaceus extract (AME) in an experimental glaucoma model. The rats used in the study were divided into six groups: one sham group, two positive control groups with topical brimonidine instillation and oral acetazolamide therapy, and three groups treated with AME (low, medium and high dosage). The antioxidant activity of AME was accessible by MDA and GPx levels. The ability to lower intraocular pressure (IOP) signified the efficiency of treating glaucoma. The results revealed that AME may decrease the MDA production and restore the GPx level in the periocular blood. This extremely beneficial effect may be by the same as that of brimonidine. Furthermore, AME also showed the ability to significantly lower IOP as is the case with brimonidine and acetazolamide. AME is a relatively safe Chinese herbal medicine with no observed side effects such as body-weight loss, or pathological change. In conclusion, the extract of Astragalus membranaceus is beneficial in treating glaucoma during the development of progression of this disease due to its significant IOP and antioxidant activities.

[Chi-Ting Horng, Ming-Liang Tsai, Jeng-Chuan Shiang, Shang-Tao Chien, Chiang-Hsiang Lu, Tsung-Hsung Chang, Fu-An Chen. **Glaucoma Treatment with the Extract of Astragalus Membranaceus in Rats Experimental Model.** Life Science Journal. 2011;8(4):124-132] (ISSN:1097-8135).
<http://www.lifesciencesite.com>.

Keywords: Astragalus membranaceus, Glaucoma

1. Introduction

Glaucoma is one of leading causes of ocular diseases. It comprises a prevalent group of retinal and optic neuropathies that currently renders approximately 67 million people worldwide at risk for developing significant vision loss including blindness. Elevated intraocular pressure (IOP) is a major factor for glaucomatous optic nerve damage. Although other factors are postulated as playing a role in glaucoma, IOP remains the best documented [1-2]. Thus, nearly all of our current glaucoma therapy is directed toward lowering IOP.

Laser and surgical procedures for glaucoma have been evaluated according to new treatment guidelines. In addition, medical therapy has been used to lower IOP for many years; the mechanisms of the medications include two major groups to control IOP by either decreasing the production or enhancing the outflow drainage of aqueous humor [3]. Because of most drugs have different side effects, plant extracts

have now been applied as one of the most attractive sources for medicinal purposes now [4].

Astragalus radix, known as huang qi, is a widely used herbal material in traditional medicine. It is one of the important "Qi tonifying" or adaptogenic herbs. It is used in cases of diarrhea, fatigue, spontaneous sweating, loss of appetite, colds and shortness of breath, chronic ulcers and sores, numbness and paralysis of the limbs, and edema. It is also believed to enhance sexual performance. Currently, much of the pharmacological research is focused on that it had the anti-inflammatory, lipid-modifying and liver-protective effects, restoring and strengthening the immune response, enhancing the cardiovascular function and increasing the vitality [5]. However, relatively little scientific information has been obtained concerning the role of Astragalus membranaceus in curing ocular diseases such as glaucoma. The purpose of our study is to determine whether the effect of the Astragalus radix

includes a reduction of IOP and a solution to its associated problems.

2. Material and Methods

Material

The *Astragalus membranaceus* (Fish.) was purchased from an oriental drug store (Pingtung, Taiwan) and was then prepared for the extraction of *Astragalus membranaceus* (AME). At first, the dried *Astragalus membranaceus* samples (200g) were immersed in a 10-fold volume of dH₂O, boiled at 80 °C for one hour, and then the water extract was collected. The process was repeated once. The fluid refluxed for one hour in a reflux extraction apparatus (Angu, Kaoshiung, Taiwan). The aqueous extract solution was then filtered using filter paper and a filter funnel. The filtered extract was dried lyophilically and then stored in an electronic dry cabinet (Komry, Taipei, Taiwan) for subsequent study.

Test animals

Thirty-six male Sprague-Dawley (SD) rats, mean age about 8 weeks, were enrolled in this experiment. Among them, 6 male SD rats belonged to the control group (group 1). The other SD rats received the subconjunctival betamethasone injection (4mg) weekly (total of 3 doses for 3 weeks). It can cause a significant increase in IOP after 3 treatments. The elevated IOP varied 30-40 mmHg in this experimental model (so the SD rats were identified as having glaucoma). The other 30 SD rats with glaucoma were divided into 5 groups (group 2 to group 6 separately received various treatments). All the SD rats were maintained under standard laboratory conditions (12 h light/dark cycle, temperature (22 ± 2) °C). Standard meals (contents of more than 25% crude protein, more than 4.5% crude fat, less than 12% water, and less than 9% ash) and sterilized water were available ad libitum. The rats were procured one week before the experiments to acclimatize them to the laboratory environment. All protocols followed the guidelines of the institutional ethics committee at Tajen University (Pingtung, Taiwan). We measured the body weight body every day and observed the daily activity and external appearance every day during the entire study. At the same time, we collected and recorded the daily total urine output for further evaluation.

Effect of SCE on IOP in the Glaucoma Model

In accordance with the various treatments, all subjects were divided into 6 groups. Group 1 (sham group, received no special therapy) was made up of rats with normal intraocular pressure. Groups 2 to 6 consisted of SD rats with glaucoma. Group 2

received topical 0.15% brimonidine instillation two times a day (Alhagan-P, Allergan, Inc., Texas, USA). Groups 3 to 6 were administered acetazolamide (Diamax, Taiwan Veterans Pharmaceutical Co Ltd., Taiwan) (78.13mg/kg/day), AME-100 (100 mg/kg/day), AME-200 (200 mg/kg/day) and ACE-500 (500 mg/kg/day) by gastric gavage, respectively. Checking IOP and periorbital blood tapping were assessed via ethanol anesthesia. All procedures in the experiment were performed in a very short time when the rats were semi-conscious and cooperative. When the study started at week 1, the IOP of the left eye of the rats was measured with the Tono-pen XL hand-held applanation tonometer (Reichert, USA). The tip of this tonometer was exactly touched the central cornea of the rats. This procedure was completed under the light-microscopy in order to avoid interfering with the inaccurate central corneal thickness reading. The results would be read automatically and the mean IOP was determined after five times. In addition, blood samples were tapped from the periorbital region of each right eye using microcapillary tubes. The total collected blood was 1 CC from every SD rat. The blood was applied to glutathione peroxidase (GPx) and TBARS (thiobarbituric acid reactive species) tests at once. At the same time, one normal rat and one glaucoma rat were sacrificed. The livers and kidneys of these rats were excised and the specimens were embedded in 20% formalin for further histological analysis. From week 2 to 5 during the experiment, the IOP of the left eye of each rat was checked. No further blood was necessary. In addition to IOP checking, the periorbital blood tapping was also carried out at the end of week 5. All the mice were sacrificed, and kidneys and livers were all dissected carefully for biopsy.

Determination of malondialdehyde (MDA) level

In the case of MDA analysis, the modified thiobarbituric acid reactive species (TBARS) assay was used to measure lipid peroxide. MDA, produced by the oxidant of polyunsaturated fatty acids, reacts with two molecules of TBA. At first, we used the above solution and shook the solution to mix it well. Then the solution was bathed under 37°C water for one hour. Each tube was given 500 µL 0.1 N HCl and 200 µL 9.8% SDS. Then 900µL pure water was poured in and mixed well: 2 mL 0.6% TBA was mixed in a 95°C hot-water bath for one hour. The solution was then cooled to room temperature for about 10 min. The n-butanol was added in the amount of 5 mL and mixed well by centrifugation at a speed of 3000 rpm for 25 min at the temperature of 25°C. The upper clear solution was taken and loaded

in a 200 μL /well. The layer of n-butanol yielded a pink-red chromogen with an absorbance maximum at 532 nm measured by the ELISA reader. We can analyze the changes of TBARS in each group before and after treatment.

Determination of glutathione peroxidase (GPx) activity

The agent RS 504 (Randox Laboratories, Antrim, UK) was purchased from the market. Blood samples were collected and only the upper layer was added with a buffer diluted to 2%. We mixed it well and heated it at 37°C for 3 minutes. Then the fluid was added with 200 μL 1.25 mM H_2O_2 and mixed well at 37°C in a water-bath for 3 minutes again. Then 4mL metaphosphate was added to the sediment protein for mixing and centrifugated under 3000 rpm at 4°C for 10 minutes. The upper clear fluid of 100 μL was poured in 100 μL 0.4 M Na_2HPO_4 and 50 μL 0.4 mg/ml DTNB. Finally, we put the mixture inside an oven at 37°C for 3 minutes in boiling water. At 422nm, absorbance was measured and in contrast with GPX, a standard curve was introduced to calculate the specific activity of GP_X (U/mL) in each extract solution. Then the levels of GPX in each group were determined.

Histopathological evaluation

All tissue specimens were buried within 20% formalin. After 24 hours, the fixative was replaced with the appropriate buffer and subsequently embedded in hydroxyethyl methylacrylate. We obtained series of sections (at an interval of 5 μm), and they were all stained with haematoxylin and eosin stain (H&E stain). The results were observed and taken pictures were taken under a light microscope (Nikon, Japan).

Statistical analysis

All values are shown with a mean \pm standard deviation (SD). The changes of GPx activity, TBARS level, IOP, and body weight before and after treatment were analyzed by an ANOVA (analysis of variance) test. If the measured IOP was less than 18 mmHg, we suggested that the period time of treatment had reached the target IOP, and "success" was defined according to the criteria of the Advanced Glaucoma Intervention Study (AGIS). A *p* value of less than 0.05 was considered significant.

3. Results

3.1 The changes of the external appearance and body weight after 5 weeks of treatment

The body-weight changes of six groups after treatment for 5 weeks of are shown in table 1. The

mice in group 3 had mild, relatively retarded growth; the other groups experienced normal weight gained. In addition, the appearance of SD rats that took oral acetazolamide had poorer quality of hair and daily exercise performance, as well as an unstable gait. The results indicated that the rats that received oral acetazolamide treatment experienced a reverse effect on body weight, external appearance and daily activity.

3.2 Effect of AME on IOP in the Glaucoma Model

The IOP of glaucoma mice in all groups (except group 1) before and after 5 week of treatment all had significant differences statistically by ANOVA test (Table 1). It showed that the SD rate with high IOP treated five weeks by topical brimonidine use, oral acetazolamide, and any doses of AME all experienced "success" (IOP < 18 mmHg)(Table 2). However, only group 3 and 6 had reached the target IOP beginning at week 4. This means that oral diacetazolamide and H-AME showed the better efficacy. In the meantime, AME-500 even revealed stronger ability to reduce IOP apparently than the AME-100 and AME-200. It may show the dose-dependent relationship in which a higher dose of AME may reduce the IOP more quickly. Furthermore, any dose of AME all should reach the target IOP after 5 weeks of treatment. The ability to reduce IOP in all AME was not any less than that of the groups that used brimonidine and acetazolamide.

Table 1: Variation in body weight and intraocular pressure(IOP) before and after various treatments for 5 weeks

Group	Before	
	Body weight(g)	IOP(mmHg)
1(n=6)	195.5 \pm 3.5	18.5 \pm 2.6
2(n=6)	202.7 \pm 2.7	36.6 \pm 2.7
3(n=6)	204.7 \pm 2.5	35.5 \pm 3.4
4(n=6)	208.9 \pm 3.5	32.5 \pm 4.5
5(n=6)	198.7 \pm 4.6	31.5 \pm 4.7
6(n=6)	204.5 \pm 4.6	34.2 \pm 3.5
Group	After	
	Body weight(g)	IOP(mmHg)
1(n=6)	360.6 \pm 6.8***	19.2 \pm 3.5
2(n=6)	368.5 \pm 17.3***	19.4 \pm 4.5*
3(n=6)	268.9 \pm 9.1*	15.7 \pm 5.5**
4(n=6)	369.7 \pm 0.5***	20.6 \pm 4.7*
5(n=6)	370.9 \pm 15.5***	19.6 \pm 5.5*
6(n=6)	362.7 \pm 9.8***	16.5 \pm 3.5**

* *P*<0.05, ** *P*<0.01, *** *P*<0.001, Significantly differed before and after treatment for 5 weeks by ANOVA

Table 2: Different intraocular pressures (IOP) of each group within each week

	Group	n	IOP (mmHg)
Week 1	1	6	13.5 ± 2.7
	2	6	37.4 ± 2.1
	3	6	35.6 ± 1.9
	4	6	33.5 ± 2.3
	5	6	36.8 ± 4.5
	6	6	39.6 ± 5.4
Week 2	1	6	15.4 ± 3.0
	2	6	32.5 ± 3.4
	3	6	30.5 ± 4.4
	4	6	30.6 ± 2.5
	5	6	32.6 ± 3.6
	6	6	33.6 ± 3.8
Week 3	1	6	14.6 ± 2.8
	2	6	27.6 ± 4.8
	3	6	25.4 ± 5.2
	4	6	35.2 ± 3.4
	5	6	34.5 ± 3.5
	6	6	32.6 ± 4.8
Week 4	1	6	16.8 ± 3.4
	2	6	20.5 ± 5.2
	3	6	17.6 ± 3.2
	4	6	25.6 ± 3.6
	5	6	22.6 ± 4.5
	6	6	17.5 ± 2.6
Week 5	1	6	15.5 ± 2.7
	2	6	16.4 ± 1.5
	3	6	13.8 ± 1.3
	4	6	17.8 ± 4.5
	5	6	16.6 ± 1.9
	6	6	15.6 ± 2.5

3.3 The total urine output before and after treatment

The total urine output in each group before and after various treatments for 5 weeks was shown (Table 3). Significant increases in daily urine output were found in group 3 (oral acetazolamide) and group 4 to 6 (any doses of AME). This demonstrated that acetazolamide may have a diuretic effect. At the same time, it is not surprising that *Astragalus membranaceus* has marked diuretic effect.

3.4 The GPx level in the periocular blood before and after treatment

Table 4 shows the GPx level in the periocular blood before and after treatment for 5 weeks was shown (Table 4). The GPx level in groups 1 and 3 revealed no significance for 5 weeks. Before the treatment in group 2, an average GPx of 6.1 ± 0.4 (u/mg protein) was noted. After treatment with

topical brimonidine instillation, it rose to 19.2 ± 1.4 (u/mg protein) ($p < 0.01$). In group 4 and 5, the GPx level apparently changed after AME-100 and AME-200 ($p < 0.01$). However, the GPx level before and after AME-500 in group 6 were noted more significantly (5.9 ± 1.0 u/mg protein vs 24.5 ± 4.9 u/mg protein; $p < 0.001$). This means that the treatment with topical brimonidine instillation and any doses of AME may restore the GPx and enhance the associated antioxidant activities in the periocular circulation.

Table 3: Variation in total urine output before and after various treatments for 5 weeks

Group	Before (ml/24hr)	After (ml/24hr)
1(n=6)	143.5 ± 10.2	148.4 ± 9.5
2(n=6)	156.4 ± 8.7	156.4 ± 10.4
3(n=6)	153.4 ± 9.5	234.8 ± 5.6**
4(n=6)	147.5 ± 8.5	198.7 ± 10.6*
5(n=6)	155.6 ± 12.5	227.5 ± 8.4**
6(n=6)	150.4 ± 9.6	239.5 ± 9.5**

* $P < 0.05$, ** $P < 0.01$, Significantly differed before and after treatment for 5 weeks by ANOVA

3.5 The TBARS level around the periocular blood before and after treatment

Table 4 shows the TBARS level in the periocular blood before and after treatment for 5 weeks was shown (Table 4). The TBARS level in group 1 revealed no significant change for 5 weeks. Before the treatment in group 2, an average TBARS of 0.8 ± 0.1 nmol/mg protein was noted. After treatment of topical brimonidine instillation, it reduced to 0.4 ± 0.2 nmol/mg protein ($p < 0.05$). In group 3, the level of TBARS revealed no remarkable change after oral acetazolamide. The TBARS level before and after any doses of AME in group 4 to 6 were all noted as be significant ($p < 0.05$). This

means that the treatment of the glaucoma mice with topical brimonidine instillation, and any doses of AME may decrease the MDA production in the periocular blood.

Table 4 : Variation in GPx and TBARS level before and after various treatments for 5 weeks

Group	Before	
	GPx (u/mg Pro)	TBARS (nmul/mg Pro)
1(n=6)	6.2±1.8	0.2±0.2
2(n=6)	6.1±0.4	0.8±0.1
3(n=6)	6.0±1.2	0.7±0.3
4(n=6)	6.1±1.1	0.8±0.2
5(n=6)	6.1±0.8	0.8±0.1
6(n=6)	5.9±1.0	0.8±0.2
Group	After	
	GPx (u/mg Pro)	TBARS (nmul/mg Pro)
1(n=6)	6.5±2.2	0.2±0.1
2(n=6)	19.2±1.4**	0.4±0.2*
3(n=6)	8.6±1.4	0.6±0.3
4(n=6)	17.5±5.4**	0.3±0.1*
5(n=6)	20.2±1.2**	0.3±0.1*
6(n=6)	24.5±4.9***	0.4±0.1*

* $P < 0.05$, ** $P < 0.01$, *** $P < 0.001$, Significantly differed before and after treatment for 5 weeks by ANOVA

3.6 The histological results of the livers and kidneys after oral acetazolamide for 5 weeks

We observed that the kidney and liver of glaucoma rats treated for 5 weeks with AME all had normal morphologic features (data not shown). Meanwhile, when the SD rats with glaucoma were treated with oral acetazolamide, the lipidosis were detected (Fig. 1). The results indicated that glaucoma

mice treated with AME showed no remarkable complications in hepatic and renal tissue. In addition, we still have to pay attention to the side effects of systemic CAIs such as acetazolamide in treating glaucoma rats for an extended time.

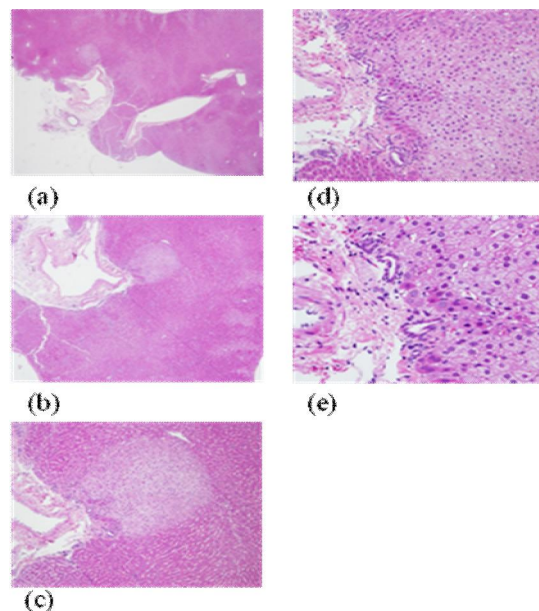

Fig. 1: The rats treated with oral acetazolamide in group 3 all showed abnormality of the cells of liver. We found that the nodules lesion with collection of abundant cytoplasm; containing micro-vesicles, consistent with fatty liver. ((a). 20x, (b). 40x, (c). 100x, (d). 200x, (e). 400x). H& E stain.

4. Discussion

Glaucoma is a disease characterized by a specific pattern of optic head and visual field damage. Although several risk factors for glaucoma have been identified, elevated IOP is the best known. If failed to effectively control IOP, the progression of glaucoma may further cause the death of the retinal ganglion cells, resulting in loss of vision. Although there is no doubt that glaucoma has been traditionally associated with high IOP, glaucoma is now considered as a multi-factorial disease. However, IOP is still the most important risk factor for the development of glaucomatous optic nerve damage. Because the higher IOP directly leads to mechanical compression and associated optic nerve damage, the ophthalmologists may try to reduce IOP at once. Now for patients with glaucoma, medical, laser, and surgical therapy are used to decrease the formation of aqueous humor or to enhance its outflow. Medical treatments which included β -adrenergic receptor antagonists (eg. Timolol), α -adrenergic receptor agonists (eg. brimonidine), carbonic anhydrase

inhibitors (CAIs) (eg. dorzolamide and acetazolamide) and prostaglandin analogues (eg. lantanoprost) are popular in treating various types of glaucoma. Until now, topical instillation of anti-glaucoma drugs is still the primary and first choice for treatment.

Most methods for induction of the glaucoma involved partial destruction of the aqueous humor outflow to abruptly raise IOP. For example, rabbits subjected to acute water loading were employed and induced the ocular hypertension model successfully. Some researchers had injected the alpha chymotrypsin into the posterior chamber of the eyes of normal rabbits. Some 70% of the animals may produce prolonged elevation in IOP because of the obstruction of the iridocorneal angle with zonular and inflammatory debris, angle closure, and peripheral anterior synechiae. Recent studies exposed animals to steroids for a long time and at a high dosage level (via eye drops, injection under the cornea or drug administration) to increase aqueous humor inflow and high IOP [6]. Galassi et al. used 0.1% dexamethasone eye drops 3 times a day for 5 weeks to induce the occurrence of glaucoma in New Zealand albino rabbits [7]; Agarwal et al. tried to use 1% prednisolone twice a day by topical instillation for 40 days to cause a rise in IOP in young rabbits. A rise of 31% -58% was observed at the end of the 40-day periods [8]. In our study, we used the method of subconjunctival betamethasone injection (4mg dose in each week, total 3 weeks) to create the experimental glaucoma model. Indeed, the rats offer advantages of availability, low purchase and maintenance costs, and ease of handling without general anesthesia which can affect the actual IOP. Therefore, we could measure the IOP quickly and correctly. At the same time, the development of the Tonopen tonometer with a small applanation tip, which was used in our study is very popular in the world [9].

The principal therapy used in the treatment of glaucoma is to reduce the IOP at first. Therefore, it is sometimes successful in halting the progression of this disease. However, the elucidation of the other prospective factors would provide us with additional targets for the development of a novel treatment. Clinically, ophthalmologists found that although IOP was well controlled in glaucoma patients, the visual field damage or optic nerve head excavation also progressed step by step. Hence, many researchers had tried to focus on other factors that impacted the glaucoma. For example, Craig and his staff stated that the possible etiology of glaucoma may be due to genetics. Anderson et al. believed that the blockage of axoplasmic transport in the optic nerve is one of

the causes of glaucoma. Quigley et al. proposed that the poor nutrition may contribute to glaucoma. Flammer et al. suggested that vascular dys-regulation should be a principal risk factor for glaucomatous damage.

Recent knowledge about glaucoma shows that we can not seek for the explanation of some dilemmas exclusively in ophthalmology and related medical disciplines, but also in the fundamental scientific disciplines of genetics and biochemistry, leading us to the genetic and molecular definition of the etiology of glaucoma. Intensive investigations of oxidative stress in glaucoma have now been done. The relationship between free radicals, oxidative stress and glaucoma is now well discussed now. Free radicals are known to occur as the natural by-products under physiological conditions. Oxyradical-induced cytotoxicity arises from both acute and chronic increases in reactive oxygen species (ROS), which give rise to subsequent lipid peroxidation. For example, Welge-Lüssen et al. stated the pathogenesis of primary open-angle glaucoma (POAG) may be the formation of oxidative stress in the trabecular meshwork [10]. Therefore the use of antioxidants and IOP-lowering drugs could help to reduce the progression of POAG. Yildirim and his coworkers contested the links of the pathogenic mechanism of glaucoma and oxidative stress by indicating a higher level of myeloperoxidase and catalase of patients with POAG [11].

Oxidative stress occurs in the chain of some acute inflammatory reactions to the ocular tissues in humans. Under certain circumstances, the level of antioxidants and associated enzymes of the aqueous humor may change. For example, superoxide dismutase (SOD) will increase in some chronic diseases including HIV infection and Alzheimer's disease. The effects on the glaucoma patients may be chronic, gradually damaging, with a cumulative effect. In patients with glaucoma, the oxidants have an important role in phagocytosis, and the oxidants damaged the blood vessels' endothelial cells, and adjoining neural tissue. Additionally, they also disturb the structure and function of numerous biomolecules and cellular organelles by increasing the accumulation of an extra-cellular matrix, resulting in a change in the cytoskeleton and cellular senescence [12]. Furthermore, the excessive free radicals will give rise to the lipid peroxidation and influence the modulation of the cellular signaling pathway and the ion transport mechanism. Zhou and his colleague mentioned that extensive oxidative stress may result in reduced trabecular meshwork cells, leading to cell loss, compromised trabecular meshwork integrity, and pathologic consequences [13]. To our

knowledge, the hydrogen peroxide (H_2O_2) and superoxide anion ($O_2^{\cdot -}$) in the anterior chamber will compromise the function of the trabecular meshwork and play an important role in the pathogenesis of glaucoma under oxidative stress. According to the previous reports, the patients with chronic glaucoma have a higher level of peroxidation. For example, Vendemiale et al. found the ability of antioxidant effects will dramatically decrease in case of glaucoma [14]. The damaged structures will decrease the drainage of aqueous humor and then cause IOP elevation in patients with glaucoma.

However, there are many antioxidant enzymes that help to reduce oxidative damage and also help to scavenge lipid hydroperoxides and protect against oxidative stress. One of them is glutathione peroxidase (GPx) that catalyze the breakdown of peroxides. It is widely accepted and experimentally proven the catabolic process can generate oxygen-free radicals and other ROS. Total antioxidant status was significantly decreased in the glaucoma group. For example, Majsterek et al. had reported that the activity of antioxidant enzymes such as GPx may decrease in POAG [15]. Thus, we believed that increased activity of GPx in the periocular blood flow may help to remove the free radicals in patients with glaucoma. Malondialdehyde (MDA), which is the end product of lipid peroxidation, not only indicates the level of lipid peroxidation, but also reflects the extent of oxygen-free radical formation. For example, Ghanem et al. tapered the aqueous humor of glaucoma patients and determined obtained that the MDA level showed an increase [16]. Chang et al demonstrated that increased levels of oxidative stress products such as MDA may be associated with primary angle-closure glaucoma [17]. Thus, the decreased MDA level presents the good antioxidant capabilities.

It had been shown that the *Astragalus membranaceus* may protect the mitochondria against lipid peroxidation and have a marked anti-oxidative ability [18]. In our study, we found that any doses of AME and topical brimonidine might increase the GPx level and decreased the MDA production significantly in the periocular circulation. Now GPx are thought to be responsible for decreased oxidative stress [19]. As we know, MDA production presents the accumulation of lipid peroxidation. Thus, we can conclude that *Astragalus membranaceus* may be beneficial in the treatment of glaucoma. In recent years, natural products with antioxidant activity have drawn the most attention. *Astragalus membranaceus* is widely used for prevention of ROS-mediated injury in pathological situation through its antioxidant properties. A literature review had revealed that the

antioxidant effects may come from Astragaloside IV, which is one of the main active components. It is a potent free radical scavenger capable of reducing both superoxide and hydroxyl radicals [20]. Astragaloside IV also may attenuate the MDA after ischemia and restored the tissue levels of GPx [21]. The biochemical process has been suggested in which the phenyl hydroxyl and cyclic propane groups are likely effective for their antioxidant properties. In our study, topical brimonidine has the same effect. On the other hand, oral acetazolamide did not show reduced MDA and increased GPx levels after five weeks. Recently, it was even reported that topical administration of dorzolamide markedly diminished oxidative stress and lowered the MDA level in patients with glaucoma [22]. Why the systemic use of acetazolamide did not show the same effect needs further investigation.

The results of this study show that topical use of brimonidine, oral acetazolamide, and any doses of AME all demonstrated significant IOP-lowering activity and reached the target IOP after 5 weeks. It is interesting to know how the mechanism of lowering IOP for *Astragalus membranaceus* works is. At first, the extracts from the root of *Astragalus membranaceus* was found to induce the vasodilation through the nitric oxide-guanosine 3',5'-cyclic monophosphate (NO-cGMP) pathway and reduce the Ca^{++} concentration in vascular smooth muscle cells [23]. Some scholars have demonstrated that the γ -aminobutyric acid from *Astragalus membranaceus* has the ability to decrease blood pressure through the mechanism of vasodilation. The hypo-tensive function of AME is equal to that of atenolol. Zhang et al. also demonstrated that the vaso-relaxant action of Astragaloside IV could increase blood flow which was attributed mainly to the endothelium-dependent NO-cGMP pathway [24]. In our opinion, the vasodilation of the smooth muscle of the afferent arterioles of the glomerulus may hence, increase the renal blood flow, the glomerular filtration rate (GFR), and the function of diuresis. Recently Memarzadeh and his coworker identified that higher systolic and mean arterial blood pressure are associated with a higher prevalence of glaucoma. They concluded that lowering the blood pressure may have the benefit of reducing the developing glaucomatous damage [25]. Thus, it showed the indirect evidence that *Astragalus membranaceus* may lower the blood pressure and IOP at the same time.

Another mechanism of the ability of *Astragalus membranaceus* in human to reduce IOP may be the diuretic effect which was ever described in ancient Chinese books, but its mechanism has not been identified. Definitely, the diuretics could increase the

urine output and decrease the volume of interstitial fluid. For example, acetazolamide could lower the IOP because of the reduction of the formation of aqueous humor and the enhancement of the diuretic function. In our study, we could find the increased amount of daily total urine output after the treatment of acetazolamide and any doses of AME. This is good evidence about lowering IOP. A recent literature review also indicates that the aqueous extract of Astragali radix may facilitate human natriuresis and diuresis [26]. Their conclusion is that AME may induce the natriuresis by means of the enhancement of the renal response to atrial natriuretic peptide (ANP). However, the active component deserves further investigation.

In clinics, acetazolamide is always administered according to the patient's condition. In recent years, acetazolamide has been often used to quickly reduce IOP before surgery or for acute glaucoma. In our study, the experimental rats were given the dosage according to their own weight. However, poor external appearance, retarded growth, and weight gain were observed apparently in the group. The fact that acetazolamide may induced metabolic acidosis is well known now. Metabolic acidosis may be a mediating factor for growth failure. Sharan et al. demonstrated that chronic metabolic acidosis exerts as an anti-anabolic effect in bone growth centers, which is partly related to a state of resistance to growth hormone and insulin-like growth factor-1 (IGF-1) [27]. This phenomenon maybe could perhaps be used to explain the retarded growth and abnormal weight gain of the SD rats with oral acetazolamide. We also found the less shiny hair and an unstable gait in this group. The carbonic anhydrases are not only distributed at the ciliary body and renal tubular lumen but also at the endothelial cells of the capillary vessels. Therefore, orally administered acetazolamide will cause the loss of potassium ions resulting in rats with hypokalemia demonstrating muscle weakness. The hypokalemic patient being treated with acetazolamide, which induces muscle weakness, has ever been reported. Acetazolamide may reduce exercise capacity associated with increased perception of leg fatigue [28]. These articles are compatible with our findings. At the same time, the liver biopsy in orally administrated acetazolamide group at the end of this experiment showed abnormal findings. We found nodule lesions with a collection of abundant cytoplasm containing micro-vesicles, consistent with fatty liver. However, we can not find out the associated problem through a Medline search. Further evaluation of the etiology and mechanism is needed. We also observed that the SD rats receiving different dosages of AME all have a normal external appearance and normal body-

weight gain. We can conclude that any dosage of AME will provide glaucoma patients with a higher efficacy, and safer method of treatment without apparent complications.

5. Conclusion

Indeed, the use of natural herbal medicine to treat glaucoma has been of interest concerned in many countries now. For example, extracts of the seeds of *Daucus carota*, and the fruits of *Aegle Marmelos* were proved to reduce the IOP [8]. In China, *Jue Ming Zi* has been used for the treatment of "green blindness" for thousands of years. Our study supported that *Astragalus membranaceus* may help to control the IOP. In addition, it also enhances the antioxidant effect around the periorcular region. Therefore, we concluded that the extract of *Astragalus membranaceus* has the theoretical and clinical bases to lower the IOP, and it could be used for the prevention and treatment of glaucoma in the near future.

Corresponding Author:

Fu-An Chen, Ph.D.

Department of Pharmacy & Graduate Institute of Pharmaceutical Technology,
Tajen University, 20 Wei-Shin Road, Yan-Pu,
Pingtung, Taiwan, ROC.

E-mail: h56041@gmail.com

References

1. Sommer A. (1989) Intraocular pressure and glaucoma. *Am J Ophthalmol*; 107: 186-8.
2. Anderson DR.(1977) The management of elevated intraocular pressure with normal optics and visual fields: I: therapeutic approach based on high risk factors. *Surv Ophthalmol*. 21: 479-89.
3. Chen JZ, Kadlubar FF. (2003) A new clue to glaucoma pathogenesis. *Am J Med*. 114(8): 697-8.
4. Corson TW, Crews CM. (2007) Molecular understanding and modern application of traditional medicines: triumphs and trials. *Cell*, 130(5): 769-74.
5. Miller AL. (1998) Botanical influences on cardiovascular disease. *Altern Med Rev*, 3(6): 422-31.
6. Gelatt KN, Brooks DE, Samuelson DA. (1998) Comparative glaucomatology II: The experimental glaucoma. *J Glaucoma*, 7(4): 282-94.
7. Galassi, F., Masini, E., Giambene, B., Fabrizi, F., Uliva, C., Bolla, M., & Ongini, E. (2006) A typical nitric oxide-releasing dexamethasone derivatives: effects of intraocular pressure and ocular haemodynamics in a rabbit glaucoma

- model. *Br J Ophthalmol*, 90(11): 1414-9.
8. Agarwal R, Gupta SK, Srivastava S, Saxena R, Agrawal SS. (2009) Intraocular pressure-lowering activity of topical application of Aegle Marmelos fruit extract in experimental animal models. *Ophthalmic Res*, 42(2): 112-6.
 9. Moore CG, Milne ST, Morrison JC.(1993) Noninvasive measurement of rats intraocular pressure with the TonoPen. *Invest Ophthalmol Vis Sci*, 34: 363-9.
 10. Welge-Lüssen U, Brike, K. (2010) Oxidative stress in the trabecular meshwork of POAG. *Klin Monbl Augenheilkd*, 227(2): 99-107.
 11. Yildirim Ö, Ates NA, Ercan B, Muslu N, Ünlü A, Tamer L, Kanik A.(2005) Role of oxidative stress in open-angle glaucoma. *Eye*, 19(5): 580-3.
 12. Izzotti A, Bagins A, Saccà SC. (2006) The role of oxidative stress in glaucoma. *Mutat Res*, 612(2): 105-14.
 13. Zhou L, Li Y, Yue BY. (1999) Oxidative stress affects cyto-skeletal structure and cell-matrix interactions in cells from an ocular tissue: the trabecular meshwork. *J Cell Physiol* , 180(2): 182-9.
 14. Vendemiale G, Grattagliano I, Altomare E. (1999) An update on the role of free radicals and antioxidant defense in human disease. In *J Clin Lab Res*, 29(2): 49-55.
 15. Majsterek I, Malinowska K, Stanczyk M, Kowalski M, Blaszczyk J, kurowska AK, Kaminska A, Szaflik J, Szaflik JP. (2011) Evaluation of oxidative stress makers in pathogenesis of primary open-angle glaucoma. *Exp Mol Pathol* , 90(2): 231-7.
 16. Ghanem AA, Arafat LF, EI-Baz A. (2010) Oxidative stress markers in patients with primary open-angle glaucoma. *Curr Eye Res*, 35(4): 295-301.
 17. Chang D, Sha Q, Zhang X, Liu P, Rong S, Han T, Liu P, Pan H. (2011) The evaluation of the oxidative stress parameters in patients with primary angle-closure glaucoma. *PLoS One*, 6(11): e27218
 18. Hong CY, Lo YC, Tan FC, Wei YH, Chen CF. (1994) *Astragalus membranaceus* and *Polygonum multiflorum* protect rat heart mitochondria against lipid peroxidation. *Am J Chin Med*, 12(1): 63-70.
 19. Hermenegildo C, Raya A, Roma J, Romero FJ.(1993) Decreased glutathione peroxidase in sciatic nerve of alloxan-induced diabetic mice and its correction with blood glucose level. *Neurochem Res*, 18: 893-9.
 20. Qui LH, Xie XJ, Zhang BQ. (2010) Astragaloside IV improves homocysteine-induced acute phase endothelial dysfunction via anti-oxidation. *Biol Pharm Bull*, 33(4): 641-6
 21. Ma Z, Yang Z. (1999) Scavenging effects of *Astragalus membranaceus* and *Gynostemma pentaphyllum* with its products on O₂⁻ and ·OH. *Zhong Yao Cai*, 22: 303-6.
 22. Zanon-Moreno V, Garcia-Medina JJ, Gallego-Pinazo R, Vinuesa-Silva I, Moreno-Nadal MA, Pinazo-Duran MD. (2009) Antioxidant status modifications by topical administration of dorzolamide in primary open-angle glaucoma. *Eur J Ophthalmol*, 19(4): 565-71.
 23. Zhang BQ, Hu SJ, Hu Qui LH. (2005) Diphasic effects of *Astragalus membranaceus* Bunge (Legminosae) on vascular tone in rat thoracic aorta. *Biol. Pharm. Bull.* 28: 1450-4.
 24. Zhang C, Wang XH, Zhong MF, Liu RH, Li HL, Zhang WD, Chen H. (2007) Mechanical underlying vasorelaxant action of Astragaloside IV in isolated rat aortic rings. *Clin Exp Pharmacol Physiol*, 34 :387-92.
 25. Memarzadeh F, Ying-Lai M, Churn J, Azen SP, Varma R. (2010) Blood pressure, perfusion, and open-angle glaucoma: the Los Angeles Latino Eye Study. *Invest Ophthalmol Vis Sci*, 51(6):2872-7.
 26. Peng A, Gu Y, Gui D, Zhu Q, Zhu K, Lin S. (2008) Aqueous extract of *Astragalus Radix* induces human natriuresis through enhancement of renal response to arterial natriuretic peptide. *J Ethnopharmacol*, 116: 413-21.
 27. Sharan S, Dupuis A, Hébert D, Levin AV. (2010) The effect of oral acetazolamide on weight gain in children. *Can J Ophthalmol*, 45(1): 41-5.
 28. Ikeda K, Iwasaki Y, Kinoshita M, Yabuki D, Igarashi O, Ichikawa Y, Satoyoshi E.(2002) Acetazolamide-induced muscle weakness in hypokalemic periodic paralysis. *Intern Med*, 41(9): 743-5.

12/12/2011

An Novel Approach for the Assembly of Bio-nanocapsules by Detonation Process

¹Yeuh-Hui Lin,* and ²Sheau-Long Lee

¹ Department of Greenery Science and Technology, Kao Yuan University, Kaohsiung 840, Taiwan, ROC

² Department of Chemistry, Chinese Military Academy, Kaohsiung 830, Taiwan, ROC

*Corresponding Author's E-mail: lin@cc.kyu.edu.tw

Abstract: Carbon bio-nanocapsules, a graphitic structure of nanoparticles with a hollow core, have been synthesized via an enhanced detonation process using a Trinitrotoulene (TNT) explosive with parts of toluene as carbon sources and solvent in the presence of titanium dioxide (TiO₂) powder as starting mixtures. Titanium nanoparticles, in situ formed from a detonation-assisted decomposition and rapid reduction of titanium dioxide, show good metal-induced activity for nanocapsule nucleation and for disproportionation reaction of from the TNT detonation. The products of hollow carbon nanocapsules are characterized by XRD, TGA, TEM and EDX techniques. The results shows that surface of hollow carbon bio-nanocapsules displays multilayer wall in structure with 0.35 nm space between the layers and the external diameter of the hollow carbon nanocapsules is 20-90 nm with the thickness of the wall is about 3-10 nm. The method is capable of assembling of the carbon nanocapsules without the participation of a catalyst. This novel method can be as an alternative technique and may give great potential for the cost-effective production of hollow carbon nanocapsules.

[Yeuh-Hui Lin, and Sheau-Long Lee. **An Novel Approach for the Assembly of Bio-nanocapsules by Detonation Process.** Life Science Journal. 2011;8(4):133-136] (ISSN:1097-8135). <http://www.lifesciencesite.com>.

Keywords: Synthesis; Nanocapsules; Explosives; Nanoparticles; Detonation; Nanocapsules.

1. Introduction

Nano-structured materials have an area of intense research recently due to novel structure-related physical and chemistry properties as well as variety of significant potential applications [1-3]. Carbon nanocapsules are basically constituted by sp² C-C covalent bonds as in graphite planes. Their syntheses have been highly successful following various routes, such as laser evaporation or arc-discharge of graphite, catalytic chemical vapor deposition, and decomposition of organic explosives [4;5]. These methods are based on a common key process: the assembly of small carbon species (C_n) generated at high temperatures. The presence of discontinued defects in the tube structures means that an individual tube could be actually viewed as an assembly of small grapheme sheets and that they could be directly synthesized from the graphene sheets under mild conditions if proper organization technology is available. Although the intrinsic high-energy consumption and intensive hardware of these techniques are mainly responsible for the high cost, the studies on the structures of carbon nanostructures have shown that the practically obtained carbon nanomaterials are highly defective and have a local structure similar to that of turbostratic graphite [6-8]. In the synthesized carbon nanostructured samples, graphitic impurity nanocapsules are always present. Using detonation chemistry for peaceful purposes is an interesting and challenging issue, especially for nanostructure constructions due to simple processing

and low production cost. This process has been developed industrially over 15 years to produce flexible graphite for the application of sealing gaskets. In the synthesized carbon nanocapsule samples, graphitic impurity nanoparticles are always present. They seriously hamper the accurate characterization of the bulk properties of nanocapsules and affect their practical applications. To remove these impurities, various purification methods have been developed. Although the graphitic nanoparticles intrinsically contain richer sub-stable nonhexagonal rings and thus are more reactive than carbon nanocapsules, the presence of defects in the tube structures renders the purification difficult. Hence, carbonaceous impurities are also frequently present in the inner voids of tubes. These internal impurities are more resistant and survive even under purification-purposed deep oxidation that causes severe damage to the tubes. How to use these impurity graphitic nanoparticles as a valuable carbon sources is of great interest but, to our knowledge, has not yet been achieved. The synthesis generally employs high-energy explosives and operates at very high loading densities to reach a detonation state with extremely high pressures and temperatures, typically a few tens GPa and thousands degrees [9]. In this paper, the detonation of a TNT explosive was used for the first time to synthesize carbon nanocapsules at HP and HT reaction conditions by introducing metal catalyst (Ti) with some content of carbon source of wax (10 wt %) into the detonation system.

2. Experimental

The detonation of TNT was performed in a sealed stainless steel pressure vessel, induced by rapid heating to its ignition temperature. TNT/Titanium dioxide/Wax mixture was prepared in desired ratios, serving as catalyst precursor and additional carbon source, respectively. When the detonation occurs, high pressure of shock wave and temperature are produced inside the vessel. After the detonation, the vessel was cooled in air and emptied of gaseous products, and then the solid products were collected. TNT was used as the explosive to generate the high temperature required and to provide part of carbon species for assembling nanocapsules [10]. A small quantity of the as-prepared carbon nanomaterials has been dispersed in ethanol and dispersed onto copper grids in order to perform detailed observations on individual carbon nanostructures by TEM and high resolution TEM

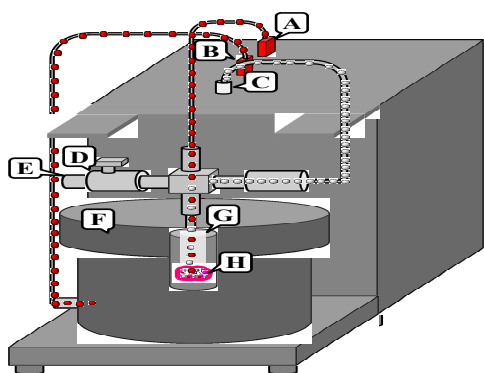

Figure 1. Schematic diagram of catalytic detonation of TNT to form nanomaterials.

In addition to the elemental metal catalyst (Ti), agglomerates of carbon nanoparticles can be seen as well. The carbon nanocapsules exhibit outer diameters of 100–120 nm. mixture are virtually stressed that simply mixing TiO_2 with 20% wax. While metal complex reaction is clearly essential, there appears to be pronounced specificity with respect to precursor structure, suggesting perhaps the necessity for certain molecular or packing features conducive to closed shell carbon construction.

Fig. 3 shows a TEM image of the obtained materials with the change of composition to Ti metal, indicating dramatic changes in composition and morphology. Carbonaceous impurities are

(HR-TEM). Energy-dispersive X-ray (EDX) analyses were coupled to TEM observations to determine the nature of the products.

3. Results and Discussion

In this research, the detonation synthetic system (Fig. 1.) can provide a unique environment, which ensures a survival of the pre-fed catalyst and simultaneously a ready generation of the C_n species. This advantage of the detonation system enables us to give an insight into the self-catalysis of carbon nanostructures under the conditions. From the SEM image and TGA results of detonation products using TNT with the mixture of Nickelocene/ $\text{C}_{14}\text{H}_{10}$, it can be seen that copper from the cartridge wall melted and solidified to lumps of different size, ranging from several hundred nanometers to over a micron (Fig. 2).

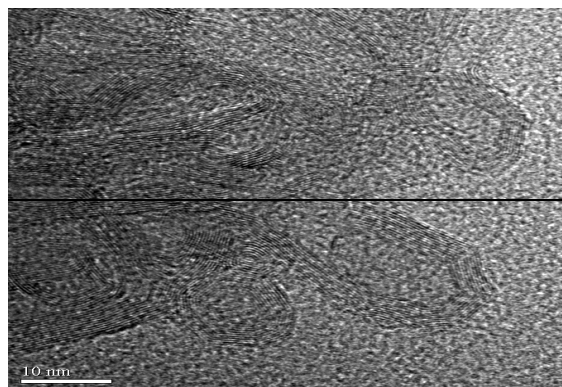

Figure 2. TEM image for the detonation of TNT to synthesis nanocapsules using Ti catalyst.

significantly reduced for both the materials external to the tubes and the materials in the cavities of the tubes. The newly formed tube walls are the consequence of the assembly of the functionalized graphene sheets. The nanostructures are well constructed, with uniform wall thickness along full tube and large interval spaces between the outer and inner tubes. The tube ends are normally open, which facilitates further intuitional observations of the perfect structures. Moreover, TEM image of an individual nanostructures assembly at its open end. Both the outer and inner tube moieties are clearly observable, confirming the encased tubular structures.

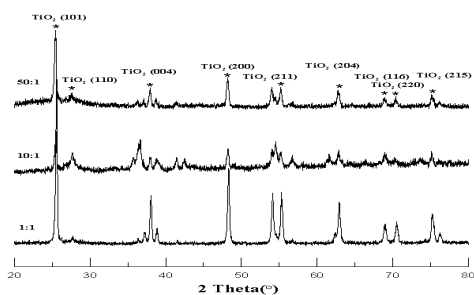

Figure 3. XRD spectrum of the as-synthesized product using TNT/TiO₂/Wax mixture.

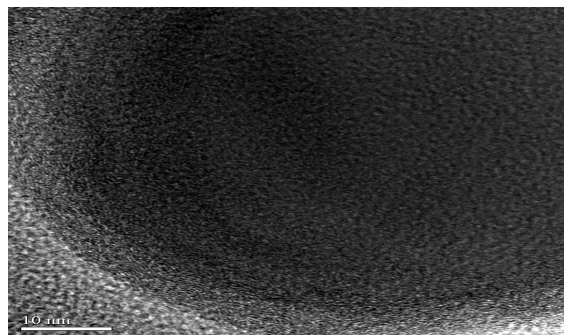

Figure 4. HRTEM image for metallic detonation of TNT to form Ti induced carbon nanostructures.

The high-yield formation of nanostructures other than re-integrated carbon particles indicates that the functionalized grapheme sheets have a preference to assemble in the direction of the pristine tubes. Combined with the uniformity of the wall thickness of the newly formed tube moieties, it also suggests that the graphene layers have very strong self-managing and self-tailoring abilities, even in the used mild wet chemical environment. Fig. 4 presents the high-resolution TEM image of the walls of a tube assembly. The wall of the inner tube shows a fishbone-like graphitic structure with interlayer distances of 0.34 nm, which is similar to the structure of pristine tubes. The outer tube is clearly the newly assembled moiety. It exhibits pre-graphitic short-rangeordered structure, with larger interlayer distances of about 0.35 nm and many discontinued and dislocated defects. Such a structure is a reflection

of the soft chemical characteristic of the assembling process involved linkage mode of the small graphene segments. Tailoring the structures into well-ordered graphitic structures is possible by annealing treatments at high temperatures, which could clip off the involved oxygen-containing groups and weld the small graphene sheets together by forming C-C bonds. Fabrication of nanostructures has been accomplished before. The present method is based on a soft chemical technology and it should be easier to rationally control the tubular structures and to produce them. The multisurface and multichannel characteristics of the tube nanostructures should be greatly beneficial for the improvement or tuning of nanocapsule properties and for wide potential applications in catalysis, gas storage and sensing, electrode materials, and so on, like the conventional single-channel nanocapsule.

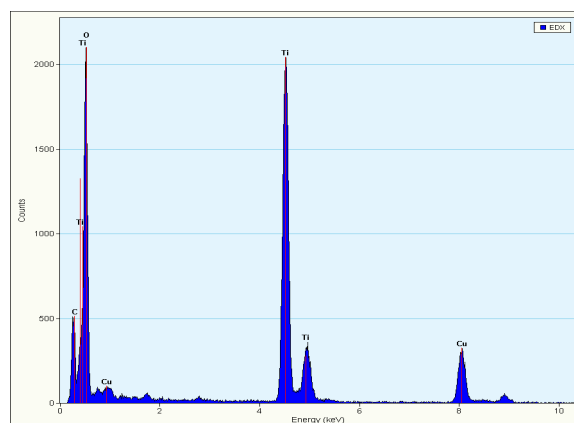
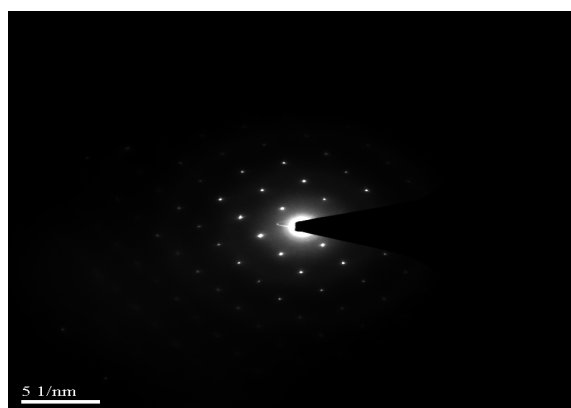

Figure 5. ED patterns and EDX mapping results of the catalytic detonation of TNT to form metallic core-shell nanoparticles

In Fig. 5, a crystalline metal particle can be seen. EDX investigation showed that it is TiO₂ particles containing small amounts of copper (from the ignition wall). Most of the nanocapsules in this sample ended in such spherical crystalline Ti particles which are not transparent to the TEM electron beam. The outer layers are not entirely parallel, indicating some degree of turbostratic disordering. In addition to the metal, the carbon nanomaterials formation was influenced by the experimental set-up, especially the method of sealing. This indicates that the pressure and temperature versus time changes need to be considered in order to fully understand or describe the nanocapsule formation by detonative decomposition techniques. A very high Ti content of nearly 100% of these lumps, was verified using EDX. Additionally, the TEM micrograph shows that the length of the tubes can reach more than a dozen microns and that they are segmented. A detailed and quantitative studies of the influence of nitrogen incorporation on the morphology of carbon nanostructures remains to be conducted in the future. In the experiments without any gasket between the steel plates, a very fast pressure decline can be assumed, as the detonation was loudly audible. The solid carbon yield in these cases was small and no tubes, only nanocapsules were found. The graphitization was not very distinct, as observed by TEM. However, no attempts were made to measure the maximum pressure or its decline as a function of time, and the conclusions of this work hence must remain qualitative.

4. Conclusion

In this paper, a very common CHNO explosive, TNT, is employed with a Ti metal as a catalyst with sufficient carbon sources introduced into the detonation system. Such a catalytic detonation process is chemically much different from that for pure explosives and facilitates practical operation. Compared to the other processes for the syntheses of carbon nanocapsules, the in-stui method used in the current work is characterized by high-density and high-pressure conditions, which experimentally shows that carbon nanostructures can grow in such an environment and provides an alternative process for producing nanostructures and a potential route for carbon bio-nanocapsule formation, especially in high density environments with the existing carbon species with the presence of Ti metal compounds.

References

1. Bethune, D. S., Kiang, C. H., de Vries, M. S. *Nature*, 605-607, 363 (1993) 6430.
2. Feng, Z., Brown, I. G., Ager, J. W., *J. Mater. Res.*, 10, 1585 (1995) 1585.
3. Monthieux, M. *Carbon*, 40 (2004) 1809.
4. Globberg, D., Bando, Y. *Appl. Phys. A*, 76(2003)479.
5. Ajayan, P. M. *Chem. Rev.*, 99 (1999) 1787.
6. Dai, H. J. *Top. Appl. Phys.* 80 (2001) 29.
7. Kang, F.; Zheng, Y. P.; Wang, H. N.; Nishi, Y.; Inagaki, M. *Carbon*, 40 (2002) 1575.
8. Ebbesen, T. W.; Ajayan, P. M.; Hiura, H.; Tanigaki, K. *Nature*, 367(1994) 519.
9. Hiura, H.; Ebbesen, T. W.; Tanigaki, K. *Adv. Mater.* 7 (1995) 275.
10. Lu, Y.; Zhu, Z. P.; Wu, W. Z.; Liu, Z. Y. *Chem. Commun.* 21 (2002) 2740.

11/21/2011

Measuring Physical Fitness Condition System with Self Healthcare Capability Based on RFID Technology

¹ Sung-Tsun Shih, ² Chian-Yi Chao, ³ Chin-Ming Hsu

¹Department of Electronic Engineering, Cheng Shiu University, Kaohsiung, Taiwan

²Department of Electronic Engineering, Kao Yuan University, Kaohsiung, Taiwan

³Department of Information Technology, Kao Yuan University, Kaohsiung, Taiwan

Corresponding Author: Sung-Tsun Shih, PhD, E-mail: stshih@csu.edu.tw

Abstract: This paper proposes a radio frequency identification-based (RFID-based) self healthcare management system which allows a user to identify his/her identification and measure/record their physical fitness and physiology conditions automatically. The system consists of a RFID tag, a RFID reader, a microprocessor-embedded main control system, and several peripherals, including blood pressure meter, ear-temperature meter, and body-weight meter, balance measurement, speed test for running back-forth measurement, etc. The RFID tag and reader are used to store and read a user's identification, physical fitness condition as well as physiology data. The main control system with MINI2440 ARM microprocessor and WinCE 6.0 platform embedded would identify the user's identification and then initiate the peripheral device to measure his/her physiology conditions. The measured data is then transmitted and stored in the RFID tag and database. The user interface and database are built by C++ codes. According to the experimental results, the proposed system with easy operations allows users to finish the process of measuring a user's physiology conditions in 3 minutes and allows users to output the measured data coupled with users' body mass index (BMI) for self health management references and support medical diagnosis to qualify the medical treatment, rehabilitation or training in advance.

[Sung-Tsun Shih, Chian-Yi Chao, Chin-Ming Hsu. **Measuring Physical Fitness Condition System with Self Healthcare Capability Based on RFID Technology.** Life Science Journal. 2011;8(4):137-142] (ISSN: 1097-8135). <http://www.lifesciencesite.com>.

Keywords: RFID, physical fitness, self health management, physiology, BMI

1. Introduction

In order to have longer life and increase life quality, people generally would trace their health conditions and prevent/control diseases and their physiology conditions by two ways, including taking time to hospital for periodical diagnostic personally or purchasing the health instruments for measuring their physical fitness conditions ordinarily. These reactions can be explained by the statement -- a good gauge of the risk for diseases that can occur with more body fat is associated with body mass index (BMI); the higher BMI will cause the higher risk for certain diseases such as heart disease, high blood pressure, type 2 diabetes, gallstones, breathing problems, and certain cancers [1]. For more examples, Crespo et al. [2] and Eissa et al. [3] discussed the association of the physical activity, physiology conditions, and diseases. Crespo et al. analyzed the data for the relationship between physical activity and overweight status to all-cause mortality in 9,136 men. Eissa et al. found that each 1-unit increase in physical activity was associated with an increase in systolic blood pressure of 0.02 mm Hg, in diastolic blood pressure of 0.01 mm Hg, and in heart of 0.02 beat/min. The conclusion made is that the association of blood pressure with physical activity was significantly less for those with higher BMI. Similar issues also have been studied specifically for American youth [4], Japanese women

[5], Chinese American children [6], and Australians [7]. In addition, several references have stated that monitoring blood pressure [8-9], body temperature [10-11], and weight loss or gained [12-13] are important to raise life index quality and lead to a longer life expectancy. Sain et al. [14] also mentioned that user healthcare data like ECG and temperature is important for basic healthcare needs.

However, the method for taking time to hospital is energy and time consuming; the method for self measuring health condition is usually based on hand writing for storing the measured data. This implies collecting and connecting these measured medical data are ineffective and inconvenient. The reference [15] proposed a sensor-based homecare health-alert system for older people and suggested that there is a need for automatic sensor-based personal healthcare systems. Therefore, to overcome the weaknesses described above, this paper applies radio frequency identification (RFID) technology to provide the advantages of storing /reading data quickly, processing large volumes of multiple data sets at the same time, improving efficiency of operations, and accurately monitoring processes for people.

RFID technology provides the advantages of storing/reading data quickly, processing large volumes of multiple data sets at the same time, improving efficiency of operations, and accurately monitoring

processes for people [16]. Several references [17-23] have applied RFID technology to manage medical data effectively and efficiently. Hsu [17] designed an intelligent real time healthcare system for far-end users. Chang [18] proposed a RFID-embedded system with capable of monitoring users' electrocardiogram (ECG) signals for long-distance self healthcare application. Lo, et al. [19] discussed the potential of RFID technology in healthcare industry. Meiller et al. [20] developed a knowledge-based system for healthcare applications with RFID generated information. Huang et al. [21] proposed the limb prosthesis healthcare self-training system. The RFID readers and tags are employed to acquire the 3D positioning information of the amputee's limbs in this work to assist in diagnosing the amputee's walking problem. Lee et al. [22] and Shih [23] used RFID technology to design a body fat or blood pressure management system with the capabilities of remote monitoring and sounding suggestions.

Therefore, this study proposes a RFID-based physical fitness condition measuring system which allows a user to identify his/her identification and measure/record their physical fitness and physiology conditions automatically. The measured outputs of the proposed system has the advantages of supporting medical diagnosis to quantify the medical treatment, rehabilitation or training as well as managing medical data effectively and efficiently. Moreover, it is compatible with most medical measurement instruments and supports easy operations. In the following, Section 2 describes the proposed self health management system. The experimental results are shown in Section 3. Finally, the conclusion and future works are summarized in Section 4.

2. Physical fitness measuring system

Figure 1 gives the system block diagram of the proposed physical fitness condition measurement system. The system includes two parts: computer and measurement. As given in Figure 1(a), the computer obtains the measured physical fitness conditions from the RFID tag via RS232 transmission cable and a user friendly interface is built by using C++ programming language. As given in Figure 1(b), the measurement part of the system consists of a RFID tag, a RFID reader, a main control board, and eight kinds of peripherals including (1) blood-pressure meter, (2) ear-temperature meter, (3) body-weight meter, (4) body-height meter, (5) body-balance meter, (6) running back/forth test, (7) thrusting forward to ground test, and (8) lying-down/sitting-up test. The RFID tag and reader are used to store and read a user's identification as well as physical fitness conditions. The main control board would process the user's identification and initiate the peripheral device to

measure his/her physical fitness conditions. Each function of the system is described in the following.

A. RFID tags and readers

Figure 2 shows the pictures of RFID reader and tag, which is compatible with the international ISO-15693 standard. The RFID tag and reader are used to store and read a user's identification as well as physical fitness condition data. The RFID reader uses ISO 18000-3 13.56 MHz band for data transmission. Table I shows the data format of the RFID tag. The first and the last block are fixed to 02 and 03. The RN stores the tag's identification, LEN stores the data length (D0 ... DN). The RFID tag totally has 28 data blocks for read/write. INS stores the operating function codes. For example, the code 02 means read and 06 means write. LRC stores the checksum code. Table II gives the data location of a user's identity and physical fitness conditions, including their ID number, name, blood pressure, height, weight, and so on.

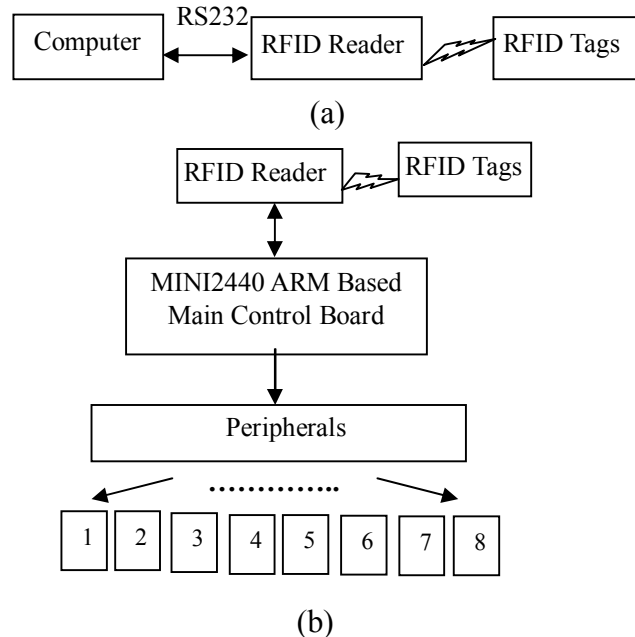

Figure 1. System block diagram of the (a) computer part; (b) physical fitness condition measurement part.

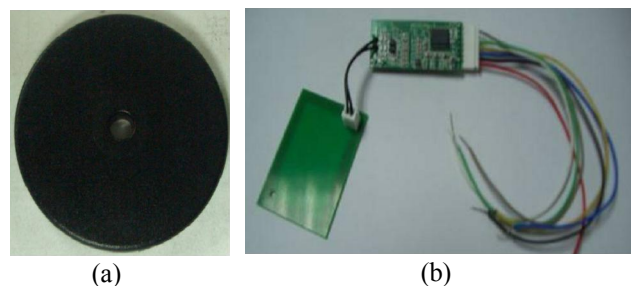

Figure 2. (a) RFID tag; (b) reader.

Table 1. The data format of the RFID tag.

02	RN	LEN	INS	D0	...	DN	LRC	03
----	----	-----	-----	----	-----	----	-----	----

Table 2. The data location of a user’s identity and physical fitness conditions

Block	Data Contents
13	Diastolic blood pressure, and heart beat rate
14	Temperature, balance, and lying-down/sitting-up
15	Weight, running back/forth, and thrusting forward to ground
16	Height and systolic blood pressure
17	Middle name
18	First name
19	Last name
20	Identification number

B. Microprocessor-embedded main control system

Figure 3 shows the circuitry block diagram of the main control board which is based on MINI2440 development board with Samsung S3C2440 ARM9 microprocessor. The system control board coupled with software control codes would process a user’s identification and initiate the measurement end to measure his/her physical fitness conditions. The hardware measurement ends includes 8 peripheral devices as stated above. The RS232 transmission interface is used to connect MINI2440 development board with the measurement ends, RFID reader, and tag. The measured data is then transmitted and stored in the RFID tag. The system components are described in the following.

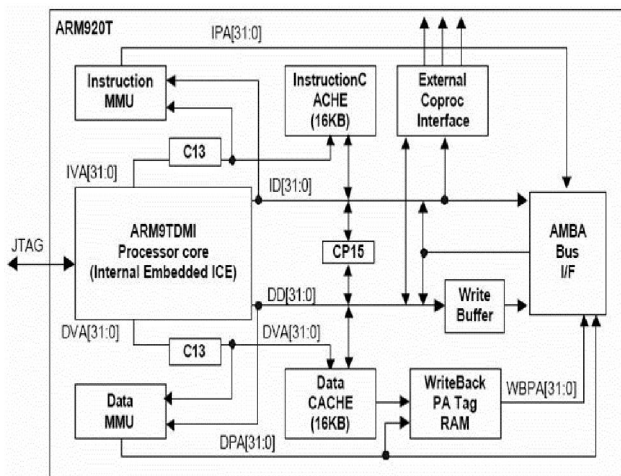

Figure 3. Circuitry block diagram of the MINI2440 development board with Samsung S3C2440 ARM9 microprocessor.

C. Soft

D. ware control codes

Figure 4 shows the flow chart of software control codes, which starts at reading the RFID tag data. After the system read the data, it shows the user’s name and identification on the screen and initiates the measurements via RS232 transmission line. The system will wait until the measured data is obtained. The system then stores the measured data in the RFID tag and database.

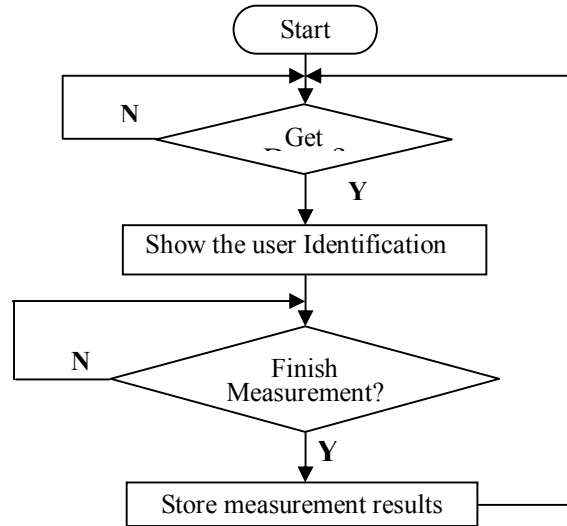

Figure 4. Flow chart of software control codes.

E. Eight peripheral measurement ends.

Three categories for measuring a user’s physical fitness condition with eight peripheral measurement ends are given in Figure 5, 6 and 7, respectively. Before starting the measurement, the main control device reads the user’s identification from their RFID tag, the user’s name and identification is then initiated via RS232 serial transmission line. After the device obtains the measured data, the buzzer sounds and the measured data is stored back in the RFID tag.

Figure 5 gives the block diagram of blood-pressure, ear-temperature, body-height, and body-balance measurement ends, where the ultrasonic distance and load cell sensors are used for measuring the user’s height and body balance ability. Figure 6 gives the block diagram of body-weight measurement end. The obtained measured data is transmitted by RS485 interface and then sent to the device by RS232 serial communication interface. Figure 7 gives the block diagram of running back/forth, thrusting forward to ground, and lying-down/sitting-up test measurement ends. Two optical sensors are used for the measurements.

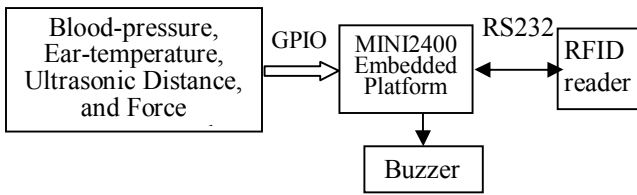

Figure 5. Block diagram of blood-pressure, ear-temperature, body-height, and body-balance measurement ends.

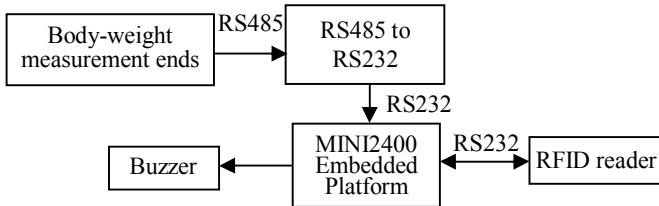

Figure 6. Block diagram of body-weight measurement ends.

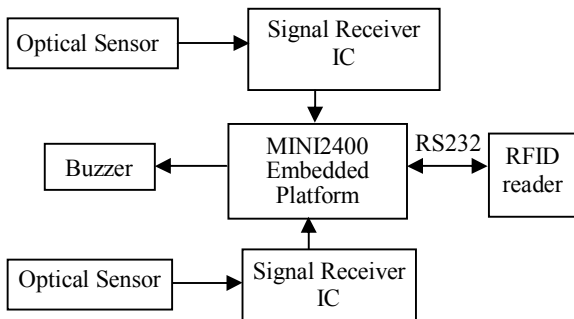

Figure 7. Block diagram of running back/forth, thrusting forward to ground, and lying-down/sitting-up test measurement ends.

F. The User Interface.

Figure 8 shows the structure of the user interface at the computer part of the system, which has six main functions, including NEW, ANALYSIS, PREVIEW, PRINT, SHOW, and EXIT. NEW is for creating a new user; ANALYSIS is for data analysis; PREVIEW is for output preview; PRINT is for printing the output; INFO is for showing the users information, the measured physical fitness data, and recommendations; and EXIT is for exiting the system.

3. Experimental results

Figure 9(a) shows the user interface starting window at the computer part of the system, which is coded by using C++ programming codes. There are six main functions shown on the bottom part of the screen, including creating a new user, data analysis,

output preview, print results, health information, and exit. The user’s personal information, including identification, name, age, gender, measuring date, and personal picture, is given on the left part of the screen. The measured data are shown at upper part of the screen and the analysis of the measured data is given on the middle part of screen. Finally, the suggestions are given at above of the main function bar. Figure 9(b) gives the creating a new user window in Chinese. At this window, the system automatically generates an identification for a user; the user has to fill out his/her name and gender.

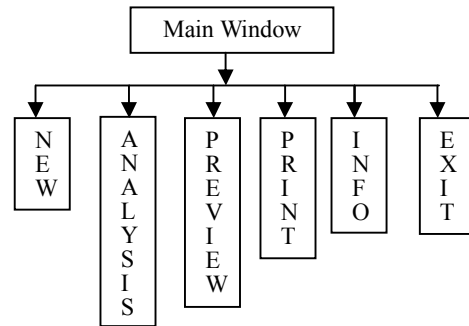
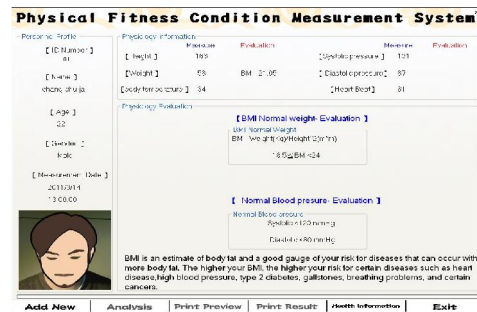
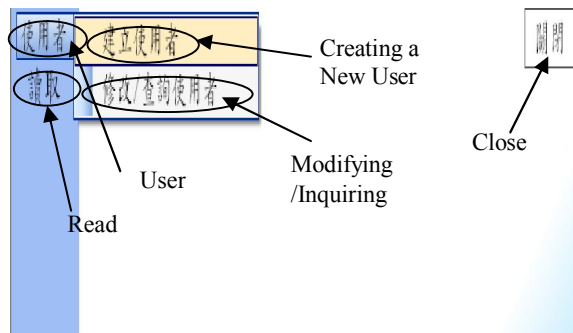

Figure 8. Structure of the user interface at the computer part of the system.



(a)



(b)

Figure 9. User interface starting window at the computer part of the system.

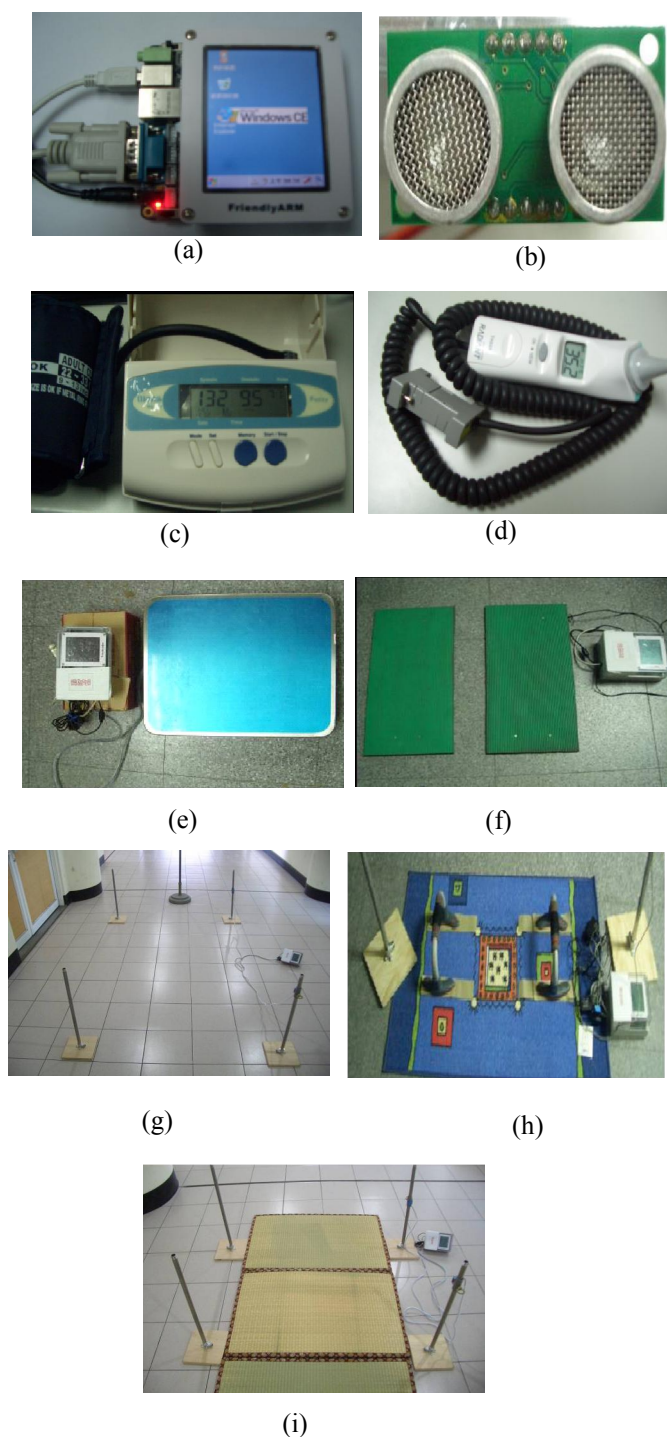

Figure 10. Measurement-ends' pictures of (a) the main control board, (b) body-height, (c) blood-pressure, (d) ear-temperature, (e) body-weight, (f) body-balance (g) running back/forth, (h) thrusting forward to ground, and (i) lying-down/sitting-up.

Figure 10 shows the measurement-ends' pictures of (a) the main control system, (b) body-height, (c) blood-pressure, (d) ear-temperature, (e) body-weight, (f) body-balance (g) running back/forth, (h) thrusting forward to ground, and (i) lying-down/sitting-up. As given in Figure 10(a), the connection between embedded system and measurement ends is based on RS232 cable. The operating system used in this study is Window CE. According to Figure 4, a user utilizes his/her RFID tag to start the measurement process—obtaining the data. After finishing the measurements, the user attaches the RFID tag to the RFID reader at the main terminal of the embedded system; the measured facts are stored in the RFID tag and are then updated in the database of the embedded system.

4. Conclusions

In this paper, a RFID-based physical fitness measurement system is proposed to allow a user to identify his/her identification and record their physiology conditions automatically. The proposed measurement system supports three advantages: (1) the develop of the user friendly interface at the computer terminal with the recommendation provides users to record their measured physical fitness conditions in the database which gives users and their family inquiry past measurement records that can be downloaded and printed for self health management references; (2) as shown in the experimental results, the proposed system with easy operations allows people to use the outputs of the measured data coupled with users' body mass index (BMI) for supporting medical diagnosis to qualify the medical treatment, rehabilitation or training; (3) the use of RFID technology would identify users correctly and efficiently, specifically for elders who are not capable of using a computer to key in their identification or who might make mistakes due to keying the wrong identification. This work can be extended to focus on building a commercial product which can make a simple diagnosis or medical suggestion whenever a user finishes the measurements.

5. References

- [1] The NHLBI Web site, <http://www.nhlbisupport.com/bmi/bmicalc.htm>
- [2] C. J. Crespo et al., "The Relationship of Physical Activity and Body Weight with All-Cause Mortality: Results from The Puerto Rico Heart Health Program", *Annals of epidemiology*, vol. 12, iss. 8, Nov. 2002, pp. 543-552.
- [3] M. A.H. Eissa, J. C. Meininger, T. Q. Nguyen, and W. Chan, "The Relationship of Ambulatory Blood Pressure to Physical Activity in a Tri-Ethnic Population of Obese and Nonobese Adolescents",

- American Journal of Hypertension, vol. 20, iss. 2, Feb. 2007, pp. 140 – 147.
- [4] A. GRAY and C. Smith, “Fitness, dietary intake, and body mass index in urban Native American youth”, Journal of the American medical Directors Association, vol. 103, iss. 9, Sep. 2003, pp. 1187 – 1191.
- [5] N. Miyatake, S. Takanami, Y. Kawasaki, and M. Fujii, “Relationship between visceral fat accumulation and physical fitness in Japanese women”, Diabetes Research and Clinical Practice, vol. 64, iss. 3, June 2004, pp. 173 – 179.
- [6] J.-L. Chen and Y. Wu, “Cardiovascular Risk Factors in Chinese American Children: Associations between Overweight, Acculturation, and Physical Activity”, Journal of Pediatric Health Care, vol. 22, iss. 2, Mar. 2008, pp. 103 – 110.
- [7] M. D. Schmidt et al., “A Comparison of Subjective and Objective Measures of Physical Activity and Fitness in Identifying Associations with Cardiometabolic Risk Factors”, Annals of epidemiology, vol. 18, iss. 5, May 2008, pp. 378-386.
- [8] S. Wagner, T. S. Toftgaard, and O. W. Bertelsen, “Novel approach for ensuring increased validity in home blood pressure monitoring”, The 4th International Conference on Pervasive Computing Technologies for Healthcare (PervasiveHealth), 2010, pp.1-4.
- [9] T. Tamura, I. Mizukura, H. Tatsumi, and Y. Kimura, “Is the home health care monitoring effective?”, Proceedings of the 9th International Conference on Information Technology and Applications in Biomedicine, ITAB, Nov. 2009.
- [10] I. H. Gomolin, P. Lester, and S. Pollack, “Older is colder: observations on body temperature among nursing home subjects”, Journal of the American medical Directors Association, vol. 8, iss. 5, Jun. 2007, pp. 335 – 337.
- [11] C. C. Lo, C. H. Chen, D. Y. Cheng, and H. Y. Kung, “Ubiquitous healthcare service system with context-awareness capability: design and implementation”, Expert Systems with Applications, vol. 38, 2011, pp. 4416-4436.
- [12] R. J. Goldberg, “Weight variance associated with atypical neuroleptics in nursing home dementia patients”, Journal of the American medical Directors Association, vol. 2, iss. 1, Jan. 2001, pp. 26 – 28.
- [13] H. K. White, E. S. McConnell, C. W. Bales, M. Kuchibhatla, “A 6-month observational study of the relationship between weight loss and behavioral symptoms in institutionalized alzheimer’s disease subjects”, Journal of the American medical Directors Association, vol. 5, iss. 2, Mar. 2004, pp. 89 – 97.
- [14] M. Sain, W. Y. Chung, H. J. Lee, “A Novel Middleware Architecture for Personal Healthcare Information System”, Journal of Convergence Information Technology, vol. 6, num. 6, June 2011, pp.127-138.
- [15] B. Moulton, Z. Khalifan, “In-home Health Alert Systems in Rural and Remote Areas of Australia: A Survey of Doctors’ and Patients’ Views”, Journal of Convergence Information Technology, vol. 6, num. 1, Jan. 2011, pp.1-14.
- [16] C. C. Chao, J. M. Yang, and W.Y. Jen, “Determining technology trends and forecasts of RFID by a historical review and bibliometric analysis from 1991-2005”, Technovation, vol. 27, iss. 5, May 2007, pp. 268-279.
- [17] F. R. Hsu, “Intelligent real time healthcare system for elders healthcare service technology”, Industrial Technology Research Institute, Oct. 2007.
- [18] K. H. Chang, “Embedded electrocardiogram (ECG) signal measurement for long-distance self healthcare application”, Master thesis, Electrical Engineering, National Cheng Kung University
- [19] K. Menzel, C. Zixiang, and L. Allan, “Potentials for radio frequency identification in AEC/FM”, Tsinghua Science and Technology, vol.13, Oct. 2008, pp.329- 335.
- [20] Y. Meiller, S. Bureau, W. Zhou, and S. Piramuthu, “Adaptive knowledge-based system for health care applications with RFID-generated information”, Decision Support Systems, vol. 51, iss. 1, Apr. 2011, pp. 198 – 207.
- [21] C. J. Huang et al., “Applications of machine learning techniques to a sensor-network-based prosthesis training system”, Applied Soft Computing Journal, vol. 11, iss. 1, Apr. 2011, pp. 3229 – 3237.
- [22] Y.-T. Lee, C.-H. Hung and C.-H. Lien, “Design of a Sounding Body Fat Management System with Remote Monitoring” Digest of Technical Papers International Conference on Consumer Electronics, 2009. ICCE '09, pp. 1 –2.
- [23] S.-T. Shih, “Synchronous TBI and ABI measurement Scheme for Diabetes Patients with Synchronous Sphygmomanometer of Four Limbs”, Life Science Journal, Vol 6, issue 4, 2009, pp.62-68.

Received October 6, 2011

Clinicopathological Significance and Prognostic Importance of Circulating Plasma DNA Expression in Advanced Non-Small Cell Lung Cancer and its Efficacy as a Diagnostic Tool

Abd El Halim Abu-Hamar¹; Hanan Shawky*¹; Ibrahim. S. Ibrahim² And Abdel Khalek H.S.³

¹Clinical Oncology Department, ²Chest Department, ³Microbiology and Immunology Department, Faculty of Medicine, Tanta University, Tanta, Egypt

*hannshawky@yahoo.com

Abstract: Background/Aim: Lung cancer is one of the commonest neoplasms. So, there is a continuous need for the development and search for new prognostic markers which will aid in diagnosis and therapy. Circulating plasma DNA levels is over-expressed in many human cancers, including lung. The aim of this work is to study the expression of circulating plasma DNA in NSCLC and assessment of its utility as a diagnostic marker, and in evaluating its impact on therapeutic efficacy as well as correlation of these data with clinicopathologic findings and patient survival to assess its prognostic significance. Patients and Methods: The amount of plasma DNA was determined through the use of real-time quantitative polymerase chain reaction (PCR) amplification of the human telomerase reverse transcriptase gene (*hTERT*) in 41 patients with advanced non-small cell lung cancer (NSCLC) and 38 age-matched controls. All of the 41 patients with advanced NSCLC received platinum-based chemotherapy. The regimen was Gemcitabine 1000 mg/m² (day 1, 8) and platinol 70 mg/m² (day 1), the cycle was repeated at interval of 21 days for at least 3 cycles. About 3 to 4 weeks after chemotherapy, response was evaluated by restaging- computed tomography. Circulating plasma DNA levels was correlated with established clinicopathologic factors, response to therapy, progression free and overall survival, and lactate dehydrogenase (LDH) levels. Results: There was a significant correlation between circulating plasma DNA levels and stage (p=0.001), LDH levels (p=0.001), smoking status (p=0.02) as well as tumor status (p=0.004). Circulating plasma DNA levels were significantly inversely correlated with treatment response (p<0.001). There was no statistical significant correlation when looking at the effect of age (p = 0.103), sex (p = 0.164), performance status (p = 0.267), pathological subtype (p = 0.26), and nodal status (p = 0.278) on the circulating plasma DNA levels. There was borderline statistical significant correlation between circulating plasma DNA levels and presence of distant metastases (p = 0.058). Circulating plasma DNA levels had also a highly significant relationship with shorter duration of PFS (p<0.001) and OS (p=0.0014). The mean circulating plasma DNA levels were 141.9 ng/mL (±56.3SD) in NSCLC patients and 69.9 ng/mL (±13.3SD) in controls, the difference being highly significant (p < 0.001). Conclusion: our results show that circulating plasma DNA levels is frequently over-expressed in primary NSCLC, and appears to be potentially useful marker for diagnosis. Overall, circulating plasma DNA levels was a significant predictor of survival and response to therapy. Circulating plasma DNA might be used as a new marker to stratify NSCLC patients for more optimal treatment modalities.

[Abd El Halim Abu-Hamar; Hanan Shawky; Ibrahim. S. Ibrahim And Abdel Khalek H.S. **Clinicopathological Significance and Prognostic Importance of Circulating Plasma DNA Expression in Advanced Non-Small Cell Lung Cancer and its Efficacy as a Diagnostic Tool**] Life Science Journal, 2011; 8(4): 143-150] (ISSN: 1097-8135). <http://www.lifesciencesite.com>.

Key words: Circulating plasma DNA, non-small cell lung cancer (NSCLC), diagnosis, clinicopathologic Study, prognosis, survival.

1. Introduction

Lung cancer is the leading cause of cancer death worldwide and NSCLC accounts for 80% of the cases⁽¹⁾. The average 5-year survival in Europe is 10%, not much better than the 8.9% observed in developing countries⁽²⁾. The poor outcome is attributable to the absence of early detection plans, the frequency of metastases at diagnosis⁽³⁾, and poor responsiveness to radiation therapy and chemotherapy⁽⁴⁾. However, survival of patients undergoing lung resection for small intrapulmonary cancers is greater than 80%⁽⁵⁾. As a consequence, there is a need to develop new tests that may

facilitate earlier diagnosis and more effective treatment.

Diagnostic assays based on blood sample analysis are attractive because of the simplicity of sample collection. Accurate analysis of tumor markers in blood from cancer patients could have significant impact in facilitating the screening, diagnosis, and monitoring for disease recurrence after initial therapy⁽⁶⁾.

With the introduction of PCR-based technologies in 1980s and refinements thereof, numerous molecular and biological markers on lung cancer tissues and exfoliated cancer cells have been

investigated⁽⁷⁾. The finding that tumors are capable of shedding nucleic acids (DNA or RNA) into the blood stream, which can be recovered from both serum and plasma and used as surrogate source of tumor DNA, has opened new areas in cancer diagnosis and prognosis in the past decade⁽⁸⁾.

It is believed that plasma/serum DNA is of tumor origin because the genetic alterations are similar to those found in the corresponding primary tumors⁽⁹⁻¹¹⁾. Thus, quantification of cell-free DNA in plasma/serum and characterization of specific molecular changes could be very useful in the management and screening of lung cancer.

To achieve maximum specificity and sensitivity, it is necessary to have a DNA concentration that does not overlap with the concentrations in control groups. It is clear that explicit cutoff values for DNA concentrations cannot be established at present because most of the published studies differ in the assays used. Three studies used real-time PCR for defining explicit DNA cutoff values^(4,6,12), but all used different genes for the amplification. It was found that higher cutoff values increased the specificity of the assay but at the cost of sensitivity and vice versa. In a study by **Leon et al.**⁽¹³⁾, 61% of lung cancer patients had higher circulating DNA concentrations [above the cutoff value of 50 µg/L; mean (SE), 164 ± 44 µg/ml]; DNA concentrations decreased in 75% of these patients after therapy.

Sozzi et al.⁽¹⁴⁾, demonstrated in their analysis of circulating tumor DNA in plasma at diagnosis and during follow-up of lung cancer patients that, DNA concentration in the follow-up plasma samples (mean, 34 µg/L) was significantly lower than before surgery (mean, 345 µg/L) and was comparable to the concentration detectable in the control group⁽¹⁴⁾. Total DNA was increased in patients with untreated cancer and in those with disease recurrence, with a sensitivity of 75% and specificity of 86%⁽¹⁴⁾. From these studies it can be concluded that no explicit cutoff has been established that can serve as a valuable tool for the diagnosis and follow-up of individuals.

In the current study, we evaluated the circulating plasma DNA levels in newly diagnosed, advanced stage NSCLC and assessing its utility as a diagnostic marker when compared with age-matched controls. In addition, evaluating its impact on therapeutic efficacy and correlating these data with clinicopathologic findings and patient survival to assess its prognostic significance.

2. Patients and Methods

Patient Characteristics & Inclusion Criteria:

A total of 41 patients with newly diagnosed, histologically confirmed advanced stage NSCLC and 38 age-matched controls (patients with benign pulmonary diseases, including 15 chronic obstructive pulmonary disease, 10 interstitial lung disease, 7 pulmonary tuberculosis, 2 sarcoidosis, and 4 bronchiectasis) treated at Clinical Oncology Department and Chest Department, Faculty of Medicine, Tanta University Hospital between May 2008 and March 2011 were studied.

All NSCLC patients were required to have advanced stage NSCLC, age less than 75 years and greater than 18 years, Eastern Cooperative Oncology Group performance status (ECOG) of 0 to 2, adequate cardiac function (EF > 60%), adequate bone marrow reserve, adequate renal and hepatic functions. Patients with NSCLC with non-malignant systemic disease that precluded them from receiving systemic chemotherapy (e.g. active infection, any clinically significant cardiac arrhythmia, or congestive heart failure) or patients who were pregnant were not eligible.

The following parameters were assessed at baseline: circulating plasma DNA levels, lactate dehydrogenase (LDH) level, bronchoscopy, ECOG performance status, weight, chest and abdominopelvic computed tomography (CT) scan, isotopic bone scan, ECG, echocardiography, and CT or magnetic resonance imaging (MRI) scan of the brain (if indicated), blood counts (Total leukocyte counts, hemoglobin, granulocytes, and platelets), and blood chemistry (renal and liver function tests).

Sample Collection and DNA Isolation:

A 7.5-mL sample of peripheral blood was collected in tubes containing EDTA, from patients at time of study entry as well as 6 months after the end of treatment from responders during follow-up period and from controls at the time of spiral CT examination, and stored at deep freeze. Plasma separation and DNA extraction were performed as previously reported by **Chang et al.**⁽¹⁵⁾. The DNA purified from 1 mL of plasma was eluted in a final volume of 50 µL of water. Testing of plasma DNA was performed by technicians with no knowledge of the patient or control status.

DNA Quantification in Plasma:

To quantify the circulating DNA in plasma, we used a real-time quantitative PCR approach based on the 5' nucleotide method. This methodology is based on continuous monitoring of a progressive fluorogenic PCR by an optical system. The PCR system uses two amplification primers and an additional amplicon-specific and fluorogenic hybridization probe, the target sequence of which is

located within the amplicon. The probe is labeled with two fluorescent dyes. One serves as a reporter on the 5' end (VIC dye; Applied Biosystems, Foster City, CA). The emission spectrum of the dye is quenched by a second fluorescent dye at the 3' end (TAMRA; Applied Biosystems). If amplification occurs, the 5' to 3' exonuclease activity of the AmpliTaq (Applied Biosystems) DNA polymerase cleaves the reporter from the probe during the extension phase, thus releasing it from the quencher. The resulting increase in fluorescent emission of the reporter dye is monitored during the PCR process.

Primers and probes were designed to specifically amplify the ubiquitous gene of interest, the *hTERT* single copy gene mapped on 5p15.33. The amplicon size of the *hTERT* gene was 98 bp (position 13059 to 13156, GenBank accession number AF128893). The sequences of the primers and of the probe were the following: primer forward, 5'-GGC ACA CGT GGC TTT TCG-3'; primer reverse, 5'-GGT GAA CCT CGT AAG TTT ATG CAA-3'; probe, VIC5'-TCA GGA CGT CGA GTG GAC ACG GTG-3' TAMRA.

Fluorogenic PCRs were carried out in a reaction volume of 50 μ L on a GeneAmp 5700 Sequence Detection System (Applied Biosystems). Fluorogenic probe and primers were custom synthesized by Applied Biosystems. Each PCR reaction mixture consisted of 25 μ L of TaqMan Universal Master Mix (Applied Biosystems), 0.67 μ L of probe (15 mmol/L), 0.45 μ L of primer forward (10 mmol/L), 0.45 μ L of primer reverse (10 mmol/L), and 18.43 μ L of sterile water. DNA solution (5 μ L) was used in each real-time PCR reaction. Thermal cycling was initiated with a first denaturation step of 50°C for 2 minutes and then 95°C for 10 minutes. The thermal profile for the PCR was 95°C for 15 seconds and 60°C for 1 minute. Data obtained during 50 cycles of amplification were analyzed.

Amplifications were carried out in 96-well plates in a GeneAmp 5700 Sequence Detection System. Each plate consisted of patient samples in triplicates and multiple water blanks as negative control. For construction of the calibration curve on each plate, we used a standard TaqMan Control Human Genomic DNA (Applied Biosystems) at 10 ng/ μ L with appropriate serial dilutions at 50, 5, 2.5, and 0.5 ng, and 250, 50, and 10 pg. Linear amplification down to the last dilution point representing 10 pg of target DNA was obtained in each experiment (correlation coefficient, 0.999 to 0.995; slope, 3.25 to 3.35).

All of the data were analyzed using the Sequence Detection System software (Applied Biosystems) to interpolate the standard amplification curve of DNA at a known quantity with amplification

cycle threshold of the unknown target sample, thus obtaining the relative amount of DNA in the experimental sample

Treatment

All of the 41 NSCLC patients had received systemic chemotherapy. Chemotherapy was applied in the form of GC regimen which consisted of a 60-120 minute intravenous infusion of gemcitabine (1000 mg/m², day 1 and 8), and platinum (70 mg/m², days 1), by intravenous infusion over 6 hrs and the cycle was repeated every 3 weeks and continued for 6 cycles unless there was evidence of disease progression or unacceptable toxicity. Patients were pre-medicated with 8 mg of dexamethasone, 50 mg of diphenhydramine, and 50 mg of ranitidine given intravenously. In addition, pre- and post-chemotherapy hydration was applied with platinum to avoid cisplatin-induced nephrotoxicity. Prophylactic use of growth factors was not recommended.

Supportive care included blood transfusions, growth factors and the administration of antiemetics and analgesics, as appropriate. The protocol provided for a decrease in Gemcitabine and platinum dose in patients experiencing grade 4 hematological toxicity or grade 3 non-hematological toxicities. G-CSF support was allowed in case of prolonged leucopenia (> 7 days) or febrile neutropenia in the prior cycle.

Evaluation of Treatment Response

Tumor response assessments were performed after 3 cycles. Response to therapy was classified according to the RECIST guidelines⁽¹⁶⁾. Evaluation was done using chest computed tomography (CT) owing to its convenient diagnosis of target lesion progress and identification of emerging new lesions.

Toxicity Evaluation:

Toxicities were graded according to the National Cancer Institute-Common Toxicity Criteria (NCI-CTCAE ver. 2.0). Treatment period was defined as the period from the initiation of therapy to 3 weeks after the last day of administration of Gemcitabine and platinum.

Follow-up Evaluation:

Basically, CT evaluations were performed every 3 months. Assessment of blood counts, blood chemistry, weight, performance status, toxicity, and chest examination was done every 3 months. Follow-up visits were scheduled every 3 months in the first 2 years after cessation of treatment and every 6 months thereafter.

Statistical analysis:

Patients were followed up until October 2011.

At the time of analysis, the mean follow-up for the entire group was 11 months (range, 3.00 to 36 months). Descriptive statistics were used to summarize patient characteristics and statistical analysis of the results was performed using SPSS version 12.0. Overall-survival (OS) rates were calculated from the time of initial treatment to the time of the last follow-up visit or death using the Kaplan-Meier method⁽¹⁷⁾. Mean and standard deviation were estimates of quantitative data. Chi-square/ Fischer exact were tests of proportion independence. Kaplan-Meier method was used for estimating survival and log rank to compare curves⁽¹⁷⁾.

3. Results

Patient characteristics:

The study included A total of 41 patients with newly diagnosed, histologically confirmed advanced stage NSCLC and 38 age-matched controls (patients with benign pulmonary diseases, including 15 chronic obstructive pulmonary disease, 10 interstitial lung disease, 7 pulmonary tuberculosis, 2 sarcoidosis, and 4 bronchiectasis) treated at Clinical Oncology Department and Chest Department, Faculty of Medicine, Tanta University Hospital between years 2008 and 2011. The age of patients with NSCLC ranging from 36 to 70 years at the time of diagnosis (mean age 55.3±7.5 years) while the mean age of the controls at the time of study entry was 57.3±7.6 years (range 37-72 years). They showed positive

history of smoking in 34 (82.9%) patients with NSCLC and in 26 cases (68.4%) of the controls. The majority of cases (63.4%) of NSCLC were T3 or greater, and node positive. The demographic data of the patients and controls and their relation to circulating plasma DNA levels were summarized in table (1). No statistically significant difference between the demographic characteristics of NSCLC patients and controls as regard to sex, smoking status, and age.

Baseline DNA concentrations were measured in plasma of 41 NSCLC patients and 38 age-matched controls. The mean circulating plasma DNA levels were 141.9 ±56.3 ng/mL in NSCLC patients and 69.9±13.3 ng/mL in controls, the difference being highly significant ($P < 0.001$). The mean DNA concentration was 2-fold higher in plasma from patients with NSCLC compared with age-matched controls (Table 1). Among the latter group, 37 (97.4%) of 38 age-matched controls presented DNA concentrations less than 104.5 ng/mL in plasma. Therefore, we defined these values as cutoff levels to differentiate between normal and elevated DNA. As determined by the Mann-Whitney rank sum test, plasma DNA concentrations were significantly higher ($P < 0.001$) in NSCLC patients than in age-matched controls. In plasma, Cox proportional hazards regression test revealed a significant trend ($P = 0.004$) towards higher DNA concentrations at advanced tumor stages.

Table (1): Demographic characteristics of patients and controls and their relation to cDNA expression

Characteristics	NSCLC group (41)		Control Group (38)		P Value
	No.	%	No.	%	
Sex					
Male	37	90.2	30	78.9	0.166
Female	4	9.8	8	21.1	
Smoking					
Smoker	34	82.9	26	68.4	0.135
Non Smoker	7	17.1	12	31.6	
Age in years					
Mean	55.3		57.3		0.346
Median	55		56		
Std. Deviation	7.5		7.6		
Range	36-70		37-72		
C- DNA levels(ng/mL)					
Mean	141.9		69.9		0.0001
Median	120.0		74.0		
Std. Deviation	56.3		13.3		
Range	40.8 - 235.6		40.8 - 105		

Circulating plasma DNA levels in correlation with clinico-pathological factors in NSCLC:

Table (2) summarizes the relation of circulating plasma DNA levels to the patient and tumor characteristics. There was a significant correlation between circulating plasma DNA levels and stage,

with a higher frequency of stage IV cancers had elevated Circulating plasma DNA levels ($P = 0.001$). There were also positive correlations between Circulating plasma DNA levels and smoking status ($P = 0.02$), LDH level ($P = 0.001$), as well as tumor status ($P = 0.004$). There was no statistical significant

correlation when looking at the effect of age ($P = 0.103$), sex ($P = 0.164$), performance status ($P = 0.267$), pathological subtype ($P = 0.26$), and nodal status ($P = 0.278$) on the circulating plasma DNA

levels. There was borderline statistical significant correlation between circulating plasma DNA levels and presence of distant metastases ($P = 0.058$).

Table (2): Circulating plasma DNA levels in relation to patient and tumor characteristics

Characteristics	No. (41)	Circulating plasma DNA levels (ng/mL)			
		Range	Mean	Median	P value
Age in years					
>60	23	40.8 – 235.6	129.3	105.6	0.103
<60	18	96.4 – 225.6	158.3	131.1	
Sex					
Male	37	56.2 – 235.5	137.9	119.7	0.164
Female	4	40.8 – 235.6	179.5	220.7	
Smoking Status					
Smoker	34	56.2 – 235.6	151.1	122.9	0.02
Non Smoker	7	40.8 – 119.7	97.8	105.6	
ECOG Performance Status					
≤2	26	40.8 – 235.6	134.5	107.3	0.267
>2	15	115.1 – 225.6	155	126.5	
Histopathology					
Adenocarcinoma	10	40.8 – 235.3	124.8	113.2	0.26
Squamous cell carcinoma	31	56.2 – 235.6	174.6	122.2	
Stage					
III	24	40.8 – 235.6	119.3	104.6	0.001
IV	17	115.1 – 235.3	174.1	193.5	
T-stage					
T1 -T2	15	40.8 – 215.8	110.1	105.6	0.004
T3 -T4	26	93.3 – 235.6	160.4	131.1	
N-Stage					
N0-N1	16	40.8 – 235.3	129.9	113.2	0.278
N2-N3	25	56.2 – 235.6	149.7	123.1	
M-Stage					
M0	32	40.8 – 235.6	133.2	115.2	0.058
M1	9	120 – 225.6	173.3	196.6	
LDH Level					
<240	18	40.8-215.8	110.4	112	0.001
>240	23	58.1- 235.6	166.8	193.5	

Relationships between Circulating Plasma DNA Levels and Response to Treatment:

Overall treatment response rate for patients with NSCLC was 39% (16/41), and tumor control rate (overall response and stable disease) was 73.2% (30/41) according to the RECIST criteria (Table 3). Complete response was observed in 3 patients (7.3%).

All objective responses were confirmed at least 4 weeks after first observation. Circulating plasma DNA levels were significantly inversely correlated with treatment response ($P < 0.001$).

Overall, the median DNA concentration of responders during follow-up (75 ng/mL) showed a clear trend toward decreases.

Table (3): Relationships between Circulating Plasma DNA Levels and Response to Treatment

Response	No. (%)	Circulating plasma DNA levels (ng/mL)			
		Range	Mean	Median	P value
Complete response (CR)	3 (7.3%)	40.8 – 117.5	94.3	103.5	0.00001
Partial response (PR)	13 (31.7%)				
Stable disease (SD)	14 (34.1%)	95.7-235.6	169.5	148	
Progressive disease (PD)	11 (26.8%)				
Objective response (CR+PR)	16 (39%)	40.8 – 117.5	94.3	103.5	
No response (SD+PD)	25 (61%)	95.7-235.6	169.5	148	

Relationships to survival:

Median PFS and OS times for all patients with NSCLC were 8 months (95% confidence interval, 9.99 - 14.01; SE: 1.02) and 12.00 months (95% confidence interval, 6.43 - 9.57; SE: 0.8), respectively, (Figures 1, 2).

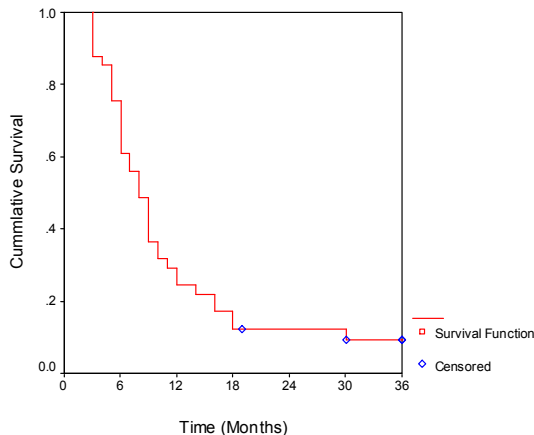

Figure 1. Kaplan–Meier curve of progression-free survival for all patients with NSCLC

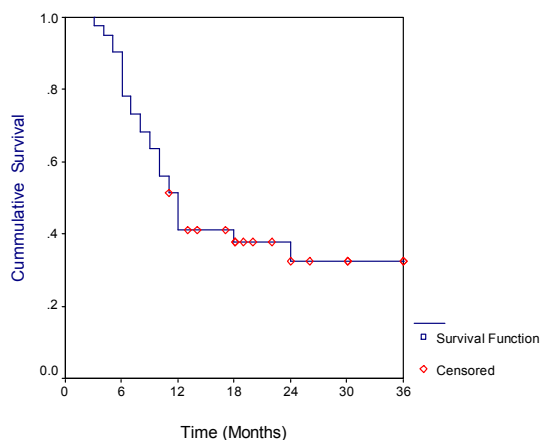

Figure 2. Kaplan–Meier curve of overall survival for all patients with NSCLC

To evaluate the prognostic significance of circulating plasma DNA levels, circulating plasma DNA levels were analyzed in relation to PFS and OS.

Circulating plasma DNA levels were significantly associated with a shortened PFS. Two-year PFS was 23.5% for patients with circulating plasma DNA levels ≤ 104.5 ng/mL (we defined these values as cutoff levels to differentiate between normal and elevated circulating plasma DNA levels) versus 4.2 % for patients with circulating plasma DNA levels > 104.5 ng/mL ($P < 0.001$) (Figure 3).

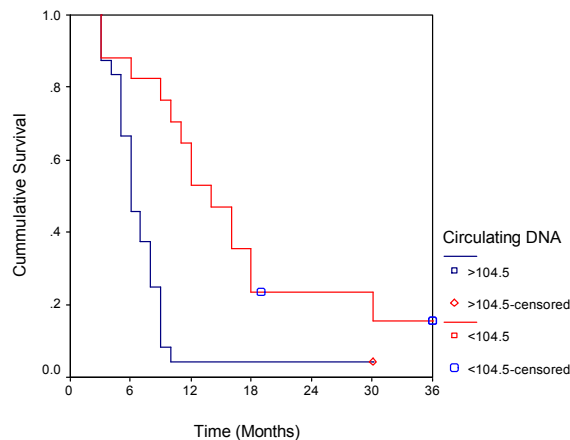

Figure 3. Progression free survival according to circulating plasma DNA levels

In terms of OS, The Kaplan–Meier survival curves demonstrate the better prognosis with circulating plasma DNA levels ≤ 104.5 ng/mL. Two-year OS was 58.4% for patients with circulating plasma DNA levels ≤ 104.5 ng/mL versus 14.3% for patients with circulating plasma DNA levels > 104.5 ng/mL ($P = 0.0014$) (Figure 4).

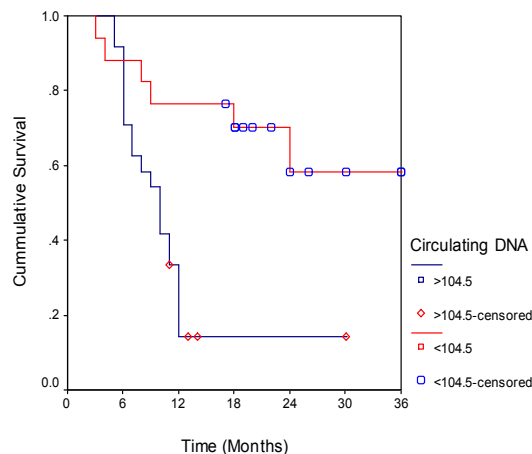

Figure 4. Overall survival according to circulating plasma DNA levels

4. Discussion

It is well recognized that tumor markers are not only of significance to the researcher in understanding tumor biology, but also to the clinician in treating patients with cancer⁽¹⁸⁾. Previous studies have reported significantly higher concentrations of circulating DNA in patients with various types of cancers, and have suggested the use of circulating DNA in cancer patients as a prognostic tool to monitor the effect of cancer therapy^(13,19).

By using a simple colorimetric assay in a

representative series of lung cancer patients and controls, we have demonstrated that a quantitative plasma DNA test is a valuable diagnostic tool to discriminate patients from age-matched controls. **Chang et al.**⁽¹⁵⁾ in their study performed in a group of miscellaneous tumors confirmed these results⁽¹⁵⁾.

Our results show that, mean circulating plasma DNA levels were 141.9 ±56.3 ng/mL in NSCLC patients and 69.9 ±13.3 ng/mL in controls, the difference being highly significant ($p < 0.001$). The mean DNA concentration was almost 2-fold higher in plasma from patients with NSCLC compared with age-matched controls. Among the latter group, 37 (97.4%) of 38 age-matched controls presented DNA concentrations less than 104.5 ng/mL in plasma. Therefore, we defined these values as cutoff levels to differentiate between normal and elevated DNA. Similar values were reported previously by **Kumar et al.**⁽²⁰⁾ in their study and could be of substantial benefit in clinical practice.

Our results showed that circulating DNA concentrations, using the 104.5 ng/mL as cutoff levels, was significantly associated with stage, smoking status, LDH level, as well as tumor status. There was no statistical significant correlation when looking at the effect of age, sex, performance status, pathological subtype, and nodal status on the circulating plasma DNA levels. There was borderline statistical significant correlation between circulating plasma DNA levels and presence of distant metastases. On the other hand, an inverse relationship was found between circulating plasma DNA levels and response to chemotherapy. Circulating plasma DNA levels had also a highly significant relationship with shorter duration of PFS and OS.

Studies in patients with NSCLC have shown conflicting data about the prognostic significance of circulating plasma DNA levels, ranging from no prognostic significance, to adverse outcome. Disparity also exists with regard to variables such as clinical staging. In studies by **Fournie et al.**⁽²¹⁾ and **Xie et al.**⁽²²⁾, plasma DNA was highest in patients with stage IV disease, whereas in other studies there was no such

association^(4,6,12-14,23). An association with age was reported in one study⁽⁴⁾ but not in the other studies^(6,12-14, 22,23). **Sozzi et al.**⁽⁴⁾ found that no significant correlation was observed between plasma DNA concentrations and smoking intensity⁽⁴⁾. Similarly, no correlation has been established with histologic subtypes. **Xie et al.**⁽²²⁾ reported higher amounts of circulating DNA in NSCLC compared with SCLC, results in contrast to those reported by **Beau-Faller et al.**⁽²³⁾.

There are conflicting reports correlating the

concentration of circulating DNA with survival. Some authors have reported no correlation between plasma DNA concentrations and PFS or OS^(14,23), whereas other authors reported an association of plasma DNA with survival, lactate dehydrogenase^(12,21), for a mixed group of SCLC and NSCLC patients⁽²¹⁾, and for NSCLC patients only⁽¹²⁾.

Overall, the median DNA concentration in our NSCLC responder patients during follow-up (75 ng/mL) showed a clear trend toward decreases, suggesting that quantification of plasma DNA might represent an approach to assess the efficacy of chemo-/radiotherapy⁽⁴⁾. **Gautschi et al.**⁽¹²⁾ reported that tumor progression after chemotherapy was significantly associated with increasing plasma DNA concentrations.

In Conclusion, the presence of circulating tumor DNA in the plasma of lung cancer patients has sparked great interest because conventional diagnostic tests tend to be imperfect and more invasive, posing logistic difficulties for serial tumor sampling. Less-invasive techniques, such as blood tests, are attractive for screening, diagnosis, prognosis, surveillance for occult disease progression, identification of potential therapeutic targets, monitoring of tumor responses, and evaluation of disease pathophysiology and biology. Moreover, levels of plasma DNA could help identify high-risk individuals for chemoprevention trials, and could be tested as a potential intermediate biomarker of the efficacy of intervention.

Corresponding author

Hanan Shawky
Clinical Oncology Department, Faculty of Medicine,
Tanta University, Tanta, Egypt
hannshawky@yahoo.com

REFERENCES

- 1- Sher Y-P, Shih J-Y, Yang P-C, *et al.*(2011): Prognosis of Non-Small Cell Lung Cancer Patients by Detecting Circulating Cancer Cells in the Peripheral Blood with Multiple Marker Genes. Downloaded from clincancerres.aacrjournals.org on May 13, 2011.
- 2- Parkin DM, Bray F, Ferlay J, *et al.*(2005): Global cancer statistics, 2002. *CA Can J Clin*; 55:74-108.
- 3- Brambilla C, Fievet F, Jeanmart M, *et al.*(2003): Early detection of lung cancer: role of biomarkers. *Eur Respir J*; 21(39): 36s-44s.
- 4- Sozzi G, Conte D, Leon M, *et al.*(2003): Quantification of free circulating DNA as a diagnostic marker in lung cancer. *J Clin Oncol*.; 21: 3902-8.
- 5- Patz E JR, Rossi S, Harpole DH Jr, *et al.*(2000):

- Correlation of tumor size and survival in patients with stage IA non-small cell lung cancer. *Chest*; 117:1568-571.
- 6- Herrera LJ, Raja S, Gooding WE, *et al.*(2005): Quantitative analysis of circulating plasma DNA as a tumor marker in thoracic malignancies. *Clin Chem.*; 51 (1):113-8.
- 7- Lacroix J, Becker HD, Woerner SM, *et al.*(2001): Sensitive detection of rare cancer cells in sputum and peripheral blood samples of patients with lung cancer by preproGRP-specific RT-PCR. *Int J Cancer*; 92:1-8.
- 8- Pathak AK, Bhutani M, Kumar S, *et al.*(2006): Circulating Cell-Free DNA in Plasma/Serum of Lung Cancer Patients as a Potential Screening and Prognostic Tool. *Clin Chem.*; 52 (10): 1833-42.
- 9- Chen XQ, Stroun M, Magnenat JL, *et al.*(1996): Microsatellite alterations in plasma DNA of small-cell lung cancer patients. *Nat Med.*; 2:1033-5.
- 10- Sozzi G, Musso K, Ratcliffe C, *et al.*(1999): Detection of microsatellite alterations in plasma DNA of non-small cell lung cancer patients: a prospect for early diagnosis. *Clin Cancer Res.*; 5: 2689-2.
- 11- Esteller M, Sanchez-Cespedes M, Rosell R, *et al.*(1999): Detection of aberrant promoter hypermethylation of tumor suppressor genes in serum DNA from non-small cell lung cancer patients. *Cancer Res.*; 59:67-70.
- 12- Gautschi O, Bigosch C, Huegli B, *et al.*(2004): Circulating deoxyribonucleic acid as a prognostic marker in non-small cell lung cancer patients undergoing chemotherapy. *J Clin Oncol.*; 22:4157-64.
- 13- Leon SA, Shapiro B, Sklaroff DM, *et al.*(1977): Free DNA in the serum of cancer patients and the effect of therapy. *Cancer Res.*; 37: 646-50.
- 14- Sozzi G, Conte D, Mariani L, *et al.*(2001): Analysis of circulating tumor DNA in plasma at diagnosis and during follow-up of lung cancer patients. *Cancer Res.*; 61: 4675-8.
- 15- Chang HW, Lee SM, Goodman SN, *et al.*(2002): Assessment of plasma DNA levels, allelic imbalance, and CA 125 as diagnostic tests for cancer. *J Natl Cancer Inst.*; 94:1697-703.
- 16- Therasse P, Arbuck SG, Eisenhauer EA, *et al.*(2000): New guidelines to evaluate the response to treatment in solid tumors. *J Natl Cancer Inst.*; 92:205-16.
- 17- Kaplan EL, Meier P.(1958): Nonparametric estimation from incomplete observations. *J Am Stat Assoc.*; 53: 457-81.
- 18- Mumbarkar PP, Raste AS and Ghadge MS.(2006): Significance of tumor markers in lung cancer. *Indian Journal of Clinical Biochemistry*; 21 (1): 173-6.
- 19- Foss AJ, Guille MJ, Occeleston NL, *et al.*(1995): The detection of melanoma cells in peripheral blood by reverse transcription-polymerase chain reaction. *Br J Cancer*; 72: 155-9.
- 20- Kumar S, Guleria R, Singh V, *et al.*(2010): Efficacy of circulating plasma DNA as a diagnostic tool for advanced non-small cell lung cancer and its predictive utility for survival and response to chemotherapy. *Lung Cancer*; 70: 211-7.
- 21- Fournie GJ, Courtin JP and Laval F.(1995): Plasma DNA as a marker of cancerous cell death: investigation in patients suffering from lung cancer and in nude mice bearing human tumour. *Cancer Lett.*; 2: 221-7.
- 22- Xie GS, Hou AR, Li LY, *et al.*(2004): Quantification of plasma DNA as a screening tool for lung cancer. *Chin Med J*; 117: 1485-8.
- 23- Beau-Faller M, Gaub MP, Schneider A, *et al.*(2003): Plasma DNA microsatellite panel as sensitive and tumor-specific marker in lung cancer Patients. *Int J Cancer*; 105:361-70

10/2/2011